

Foster 

Catalogo listino prezzi
2022

eleganza, affidabilità,
rispetto per l'ambiente.
Foster per vivere la qualità.

FOSTER Collections

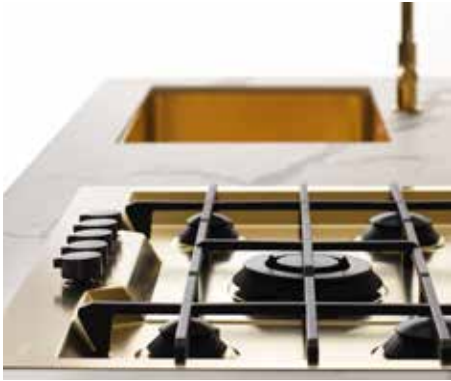

PVD Collections 08

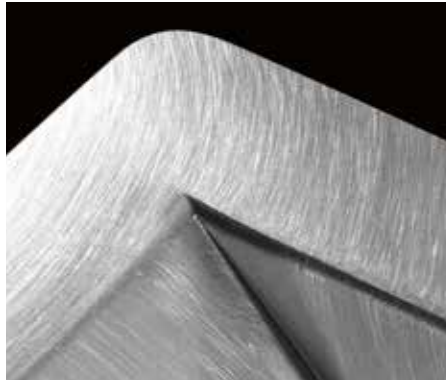

Vintage Collection 36



Foster Marine Collection 44

Lavelli



50

Piani cottura a gas



214

Lavelli Sottotop



112

Forni & Coordinati



247

Complementi



140

Cappe



265

Miscelatori



156

Lavastoviglie



292

Piani induzione



190

Top inox



294





La Qualità nella Quotidianità

Ricerca, stile e bellezza tutte in un segno, il marchio Foster.

Il desiderio di trovare sempre nuove soluzioni per migliorare la qualità della vita in cucina è il motore della nostra ricerca, la ragione della nostra soddisfazione.

Abbiamo stabilito importanti traguardi nello sviluppo degli elettrodomestici e con lo stesso entusiasmo, ogni giorno, ci confrontiamo con le idee dei più quotati fabbricanti di cucine italiani e del mondo.

Questa è la filosofia Foster: standard qualitativi d'eccellenza, alta maestria nella lavorazione dei materiali, soluzioni sempre innovative interpretate con il gusto e lo stile che ci contraddistinguono.

Foster 



Chi siamo

Fondata nel 1973, Foster è un'azienda italiana con quattro stabilimenti produttivi che opera in più di 50 paesi nel mondo. Un'organizzazione integrata con sede nello storico Palazzo Terranova di Brescello, piccolo borgo famoso per i film di Don Camillo e Peppone e simbolo dell'operosità della provincia del Nord Italia.



Ispirati da Arte e Cultura

Palazzo Terranova non è solo la sede, è l'espressione dell'amore che Foster nutre per l'arte.

È il 1988 quando Foster stabilisce qui la propria sede, dopo l'intervento di recupero conservativo dell'ex convento francescano del '600. Il restauro ha restituito splendore ai prestigiosi affreschi ed ha portato alla luce antichi reperti storici.

Palazzo Terranova è un patrimonio culturale che l'azienda ha voluto restituire alla comunità in tutta la sua storia, bellezza e magnificenza. Foster è stata tra le prime aziende italiane ad aderire ai progetti per la salvaguardia e tutela del territorio ed il palazzo è oggi sotto la tutela della Soprintendenza per i Beni Architettonici e Paesaggistici.

FOSTER Collections





PVD Collections





il trattamento PVD

Si ottiene tramite un processo fisico, non chimico, con resistenza superiore ad ogni altro trattamento.

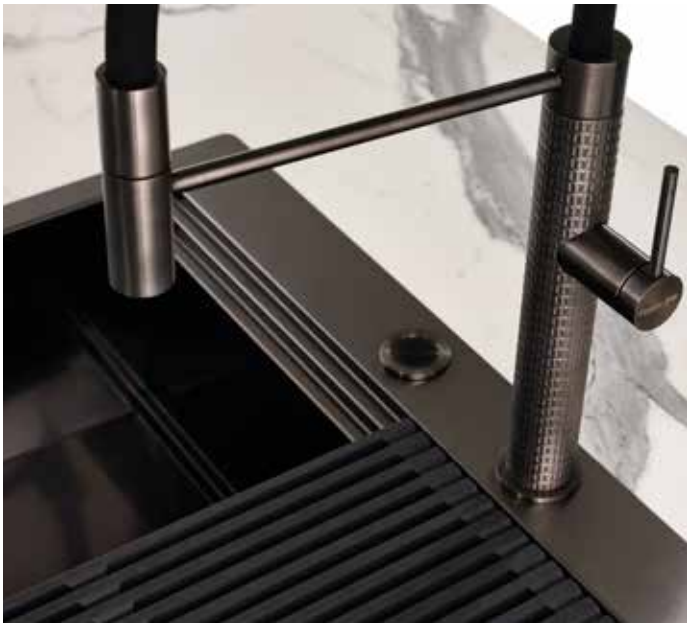

le caratteristiche degli acciai PVD:

- eccezionale durezza superficiale
- più resistenza all'usura e all'abrasione
- più resistenza alla corrosione, ai solventi,
ai detersivi,
ai cibi ad alta acidità
- inalterabilità ai raggi UV
- eco-compatibile
- trattamento ipoallergenico

Rispettoso della tua salute e della nostra terra

Il trattamento PVD è totalmente ipoallergenico, e utilizzato in tante applicazioni per prodotti che vengono a contatto con la pelle e con gli alimenti. Una sicurezza in più per la nostra salute.

L'acciaio PVD è **100% green**. Il processo produttivo non rilascia alcuna sostanza dannosa e il prodotto mantiene tutte le qualità dell'acciaio in tema di eco-sostenibilità, totalmente riciclabile per un pieno rispetto dell'ambiente.

Le finiture spazzolate e vintage



PVD Gun Metal spazzolato



PVD Gold spazzolato



PVD Copper spazzolato



PVD Gun Metal Vintage



PVD Gold Vintage



PVD Copper Vintage



PVD Gun Metal Collection





L'acciaio
con il vestito scuro.





PVD Gun Metal Collections

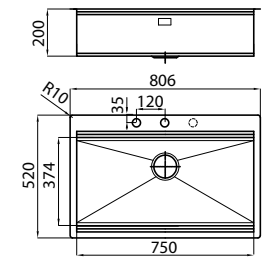

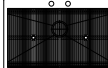
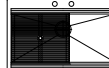
Lavelli Milanello Gun Metal

| | Caratteristiche | Versione | Sigla | Prezzo € | Disegno Tecnico |
|--|--|---|--|------------------------|---|
| Base 80  | AISI 304 Gun Metal dimensioni: 806x520 1 vasca: 750x374 incasso FT: vedi sito web incasso FTS: 789x503 piletta: automatica tipo Space Push (PO) 3½" |  FT | 1034 056 | € 2.585,00 |  |
| | |  FTS | 1034 056 | | |
| In dotazione: 2 griglie Black Milanello (8100 602) | | | | | |
| Accessori opzionali: Z3 T8 M7 L3 L4 N3 N2 P2 T T2 Z Z2 | | | | | |
| | |  Configurazione griglie Black a filo vasca |  Configurazione griglie Black su fondo vasca | possibilità terzo foro | |

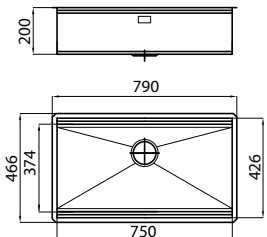
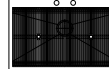
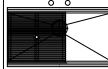
| | | | | | |
|--|---|--|--|-------------------|---|
| Base 90  | AISI 304 Gun Metal vasca: 750x374 dimensioni: 790x466 incasso: v. sito web piletta: 3½" Gun Metal |  ST | 1034 856 | € 2.304,00 |  |
| | | | | | |
| In dotazione: 2 griglie Black Milanello (8100 602) | | | | | |
| Accessori opzionali: Z3 T8 L3 L4 M7 N3 N2 P2 T T2 Z Z2 | | | | | |
| | |  Configurazione griglie Black a filo vasca |  Configurazione griglie Black su fondo vasca | | |

In dotazione

Dotazioni Standard: ganci di fissaggio, guarnizione (no per sottotop), piletta, troppo/pieno e sifone. Imballo in scatola di cartone.



n. 2 griglie
Black Milanello

Accessori

accessori opzionali scorrevoli sotto le griglie



Z3
Vaschetta forata
inox 21,5x40 cm
8156 000
€ 274,00



T8
Griglia portapiatti
inox 21,4x37,2 cm
8100 306
€ 80,00

altri accessori opzionali



L3
Tagliere Twin
41x41 cm
8644 004
€ 242,00



L4
Tagliere cristallo
23x41 cm
8631 300
€ 96,00



M7
Tagliere legno nuce
15,8x42,4 cm
8642 003
€ 83,00



N2
Tagliere in HDPE
27,2x42,5 cm
8657 001
€ 74,00



N3
Tagliere Twin
in HDPE 31,7x42,5
8644 101
€ 109,00



P2 **
Kit grattugie con
anello-supporto e
vaschetta vivande
8159 101
€ 146,00



T *
Griglia portapiatti
inox 25x35 cm
8100 154
€ 69,00



T2 **
Cestello portapiatti
inox 21,4x37,9 cm
8100 303
€ 93,00



Z *
Scolapasta inox
25x36 cm
8154 000
€ 187,00













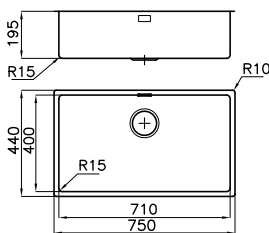

Z2 **
Vaschetta forata
inox 21,5x38 cm
8151 000
€ 279,00

*utilizzabile solo in abbinamento al tagliere L3 **utilizzabile solo in abbinamento al tagliere N3

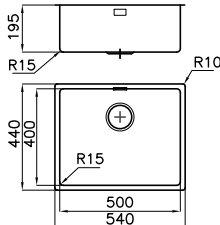
PVD Gun Metal Collections



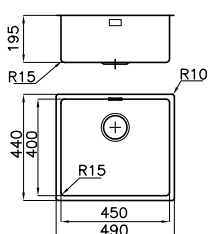







Lavelli KE Gun Metal

| | Caratteristiche | Versione | Sigla | Prezzo € | Disegno Tecnico |
|--|--|---|----------|------------|---|
| Base 80  | AISI 304 Gun Metal dimensioni: 750x440 1 vasca: 710x400 incasso FT: v. sito web* incasso FTS: 730x420* piletta: 3½" |  FT | 2157 056 | € 1.280,00 |  |
| | |  FTS | 2157 056 | | |
| | AISI 304 Gun Metal vasca: 71x40 cm dimensioni: 750x440 incasso: vedi sito web piletta: 3½" |  ST | 2157 856 | € 1.188,00 | |
| Accessori: L3 L4 N2 N3 O2 P2 P4 S T T1 T2 Z Z2 (v. pag. 19) Pilette autom.: PG PO (v. pag. 148-149) | * il foro incasso necessita di intaglio per l'alloggio del troppo-pieno (vedi sito web) | | | | |
| Base 60  | AISI 304 Gun Metal dimensioni: 540x440 1 vasca: 500x400 incasso FT: v. sito web* incasso FTS: 520x420* piletta: 3½" |  FT | 2155 056 | € 928,00 |  |
| | |  FTS | 2155 056 | | |
| | AISI 304 Gun Metal vasca: 50x40 cm dimensioni: 544x444 incasso: vedi sito web piletta: 3½" |  ST | 2155 856 | € 903,00 | |
| Accessori: L3 L4 N2 N3 O2 P2 P4 S T T1 T2 Z Z2 (v. pag. 19) Pilette autom.: PG PO (v. pag. 148-149) | * il foro incasso necessita di intaglio per l'alloggio del troppo-pieno (vedi sito web) | | | | |
| Base 60  | AISI 304 Gun Metal dimensioni: 490x440 1 vasca: 450x400 incasso FT: v. sito web* incasso FTS: 470x420* piletta: 3½" |  FT | 2154 056 | € 919,00 |  |
| | |  FTS | 2154 056 | | |
| | AISI 304 Gun Metal vasca: 45x40 cm dimensioni: 490x440 incasso: vedi sito web piletta: 3½" |  ST | 2154 856 | € 863,00 | |
| Accessori: L3 L4 N2 N3 O2 P2 P4 S T T1 T2 Z Z2 (v. pag. 19) Pilette autom.: PG PO (v. pag. 148-149) | * il foro incasso necessita di intaglio per l'alloggio del troppo-pieno (vedi sito web) | | | | |

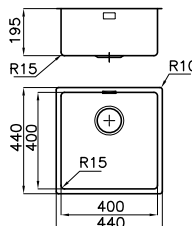
Dotazioni Standard: ganci di fissaggio, guarnizione (no per sottotop), piletta, troppo/pieno e sifone. Imballo in scatola di cartone.

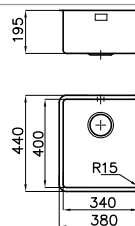

Lavelli KE Gun Metal

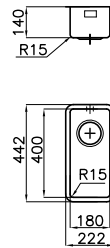









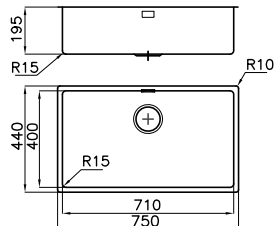

| | Caratteristiche | Versione | Sigla | Prezzo € | Disegno Tecnico |
|--|---|--|----------|-----------------|---|
| Base 45  | AISI 304 Gun Metal dimensioni: 440x440 1 vasca: 400x400 incasso FT: v. sito web* incasso FTS: 420x420* piletta: 3 1/2" |  FT | 2156 056 | € 887,00 |  |
| | |  FTS | 2156 056 | | |
| | AISI 304 Gun Metal vasca: 40x40 cm dimensioni: 440x440 incasso: vedi sito web piletta: 3 1/2 |  ST | 2156 856 | € 825,00 | |
| Accessori: L3 L4 N2 N3 O2 P2 P4 S T T1 T2 Z Z2 (v. pag. 19) Pilette autom.: PG PO (v. pag. 148-149) | * il foro incasso necessita di intaglio per l'alloggio del troppo-pieno (vedi sito web) | | | | |
| Base 40  | AISI 304 Gun Metal vasca: 34x40 cm dimensioni: 380x440 incasso: vedi sito web piletta: 3 1/2 |  ST | 2153 856 | € 801,00 |  |
| | | Accessori: L4 N2 N3 O2 P2 P4 R T2 T1 Z2 Pilette autom.: PG PO (v. pag. 148-149) | | | |
| Base 30  | AISI 304 Gun Metal vasca: 18x40 cm dimensioni: 222x442 incasso: vedi sito web piletta: 3 1/2 |  ST | 2151 856 | € 497,00 |  |
| | | Accessori: L4 N2 N3 O2 P2 P4 R T2 T1 Z2 Pilette autom.: PG PO (v. pag. 148-149) | | | |

PVD Gun Metal Collections

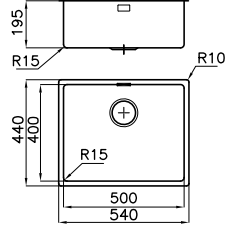

Finitura Vintage

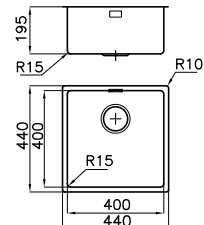
Lavelli KE Gun Metal Vintage **NEW**

| | Caratteristiche | Versione | Sigla | Prezzo € | Disegno Tecnico |
|--|--|---|----------|-------------------|---|
| Base 80  | AISI 304 Gun Metal Vintage dimensioni: 750x440 1 vasca: 710x400 incasso FT: v. sito web* incasso FTS: 730x420* piletta: 3½" |  FT | 2157 086 | € 1.501,00 |  |
| | |  FTS | 2157 086 | | |
| | AISI 304 Gun Metal Vintage vasca: 71x40 cm dimensioni: 750x440 incasso: vedi sito web piletta: 3½" |  ST | 2157 886 | € 1.379,00 | |
| Accessori: L3 L4 N2 N3 O2 P2 P4 S T T1 T2 Z Z2 (v. pag. 19) Pilette autom.: PG PO (v. pag. 148-149) | * il foro incasso necessita di intaglio per l'alloggio del troppo-pieno (vedi sito web) | | | | |
| Base 60  | AISI 304 Gun Metal Vintage dimensioni: 540x440 1 vasca: 500x400 incasso FT: v. sito web* incasso FTS: 520x420* piletta: 3½" |  FT | 2155 086 | € 1.092,00 |  |
| | |  FTS | 2155 086 | | |
| | AISI 304 Gun Metal Vintage vasca: 50x40 cm dimensioni: 544x444 incasso: vedi sito web piletta: 3½" |  ST | 2155 886 | € 970,00 | |
| Accessori: L3 L4 N2 N3 O2 P2 P4 S T T1 T2 Z Z2 (v. pag. 19) Pilette autom.: PG PO (v. pag. 148-149) | * il foro incasso necessita di intaglio per l'alloggio del troppo-pieno (vedi sito web) | | | | |
| Base 45  | AISI 304 Gun Metal Vintage dimensioni: 440x440 1 vasca: 400x400 incasso FT: v. sito web* incasso FTS: 420x420* piletta: 3½" |  FT | 2156 086 | € 991,00 |  |
| | |  FTS | 2156 086 | | |
| | AISI 304 Gun Metal Vintage vasca: 40x40 cm dimensioni: 440x440 incasso: vedi sito web piletta: 3½" |  ST | 2156 886 | € 847,00 | |
| Accessori: L3 L4 N2 N3 O2 P2 P4 S T T1 T2 Z Z2 (v. pag. 19) Pilette autom.: PG PO (v. pag. 148-149) | * il foro incasso necessita di intaglio per l'alloggio del troppo-pieno (vedi sito web) | | | | |

Dotazioni Standard: ganci di fissaggio, guarnizione (no per sottotop), piletta, troppo/pieno e sifone. Imballo in scatola di cartone.

accessori



L3
Tagliere Twin
41x41 cm
8644 004
€ 242,00



L4
Tagliere cristallo
23x41 cm
8631 300
€ 96,00



M
Tagliere scorrevole
30x54 cm
8643 000
€ 114,00



N2
Tagliere in HDPE
27,2x42,5 cm
8657 001
€ 74,00



N3
Tagliere Twin
in HDPE
31,7x42,5 cm
8644 101
€ 109,00



O2
Vaschetta bianca
27,2x41,4 cm
8153 100
€ 39,00



P2 **
Kit grattugie con anello-
supporto e vaschetta
raccogli vivande
8159 101
€ 146,00



P4
Kit tagliere
con vaschetta
scolapasta
in acciaio inox
8644 044
€ 278,00



R
Cestello Inox 34x40 cm
8611 000
€ 50,00



S
Cestello Inox 40x40
8612 000
€ 58,00
Cestello bianco 40x40
8612 100
€ 37,00



T *
Griglia portapiatti
25x35 cm
8100 154
€ 69,00

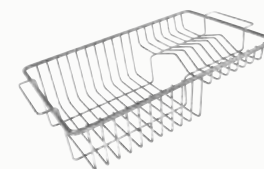

T1
Cestello portapiatti
25x42,5 cm
8100 201
€ 87,00

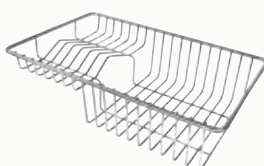

T2 **
Cestello portapiatti
inox 21,4x37,9 cm
8100 303
€ 93,00



Z *
Scolapasta inox
25x36 cm
8154 000
€ 187,00



Z2 **
Vaschetta forata
inox 21,5x38 cm
8151 000
€ 279,00

*utilizzabile solo in abbinamento al tagliere L3 **utilizzabile solo in abbinamento al tagliere N3

PVD Gun Metal Collections

Skin Gun Metal

Miscelatore monocomando con canna girevole e doccia snodabile.

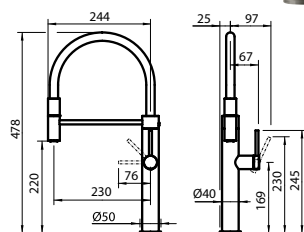

Parti estetiche in acciaio AISI 316 con trattamento PVD
piastra di rinforzo inclusa
foro per miscelatore: \varnothing 35 mm
base d'appoggio: \varnothing 50 mm
angolo di rotazione: 360°
cartuccia con dischi ceramici
spessore max top: 40 mm

Sigla
8424 856
Gun Metal
Satinato

Prezzo €
€ 1.477,00

Omega Plus Gun metal

Miscelatore monocomando con canna girevole e bocca estraibile.

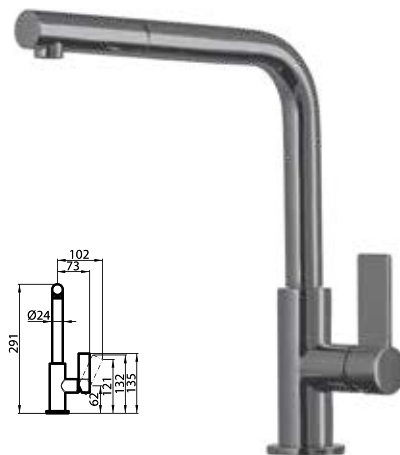
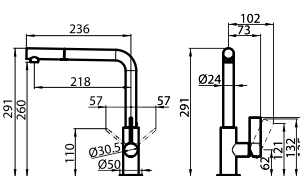

piastra di rinforzo inclusa
foro per miscelatore: \varnothing 35 mm
base d'appoggio: \varnothing 50 mm
angolo di rotazione: 360°
cartuccia con dischi ceramici
spessore max top: 40 mm
ingombro posteriore per
rotazione comando: 35 mm

Sigla
8498 856
Gun Metal

Prezzo €
€ 598,00

Omega Gun metal

Miscelatore monocomando con canna girevole.

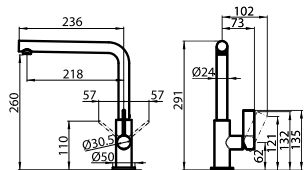

piastra di rinforzo inclusa
foro per miscelatore: \varnothing 35 mm
base d'appoggio: \varnothing 50 mm
angolo di rotazione: 360°
cartuccia con dischi ceramici
spessore max top: 40 mm
ingombro posteriore per
rotazione comando: 35 mm

Sigla
8497 856
Gun Metal

Prezzo €
€ 472,00

Dispenser Evo Gun metal*

Distributore da incasso per detersivo/sapone liquido.

* Gun metal lucido realizzato su finitura cromata, si abbina ai miscelatori Omega gun metal.

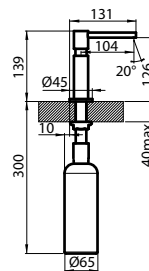

Sigla
8520 856
Gun Metal

Prezzo €
€ 306,00



Complementi Gun Metal



Portaprese Reverse Gun metal
Slot portaprese push in acciaio inox PVD Gun Metal per incasso su piani da lavoro
- 2 prese Schuko - 1 presa USB per ricarica
Foro incasso: 215x88 mm

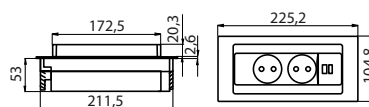

| | |
|----------|----------|
| Sigla | Prezzo € |
| 8000 116 | € 528,00 |

PO



Piletta automatica **Space Push Gun Metal** con comando remoto rotondo a pressione e con troppo/pieno perimetrale. Doppio tappo in dotazione: Space e "a cestello" Gun Metal.

| | |
|----------|----------|
| Sigla | Prezzo € |
| 8407 120 | € 150,00 |



PG



Piletta automatica **Gun metal** con comando remoto tondo rotante e con troppo/pieno perimetrale

| | |
|----------|----------|
| Sigla | Prezzo € |
| 8407 110 | € 93,00 |













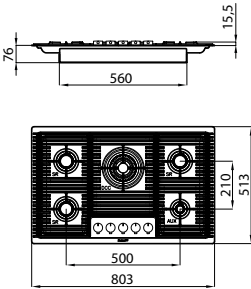

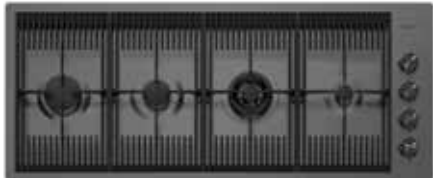
PVD Gun Metal Collections

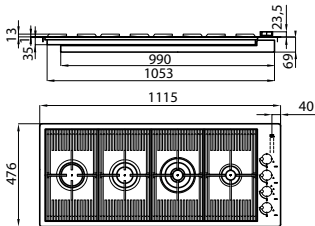

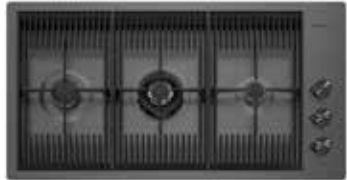

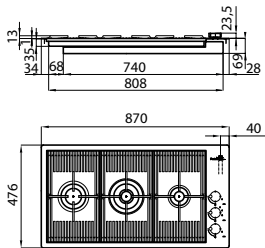
Foster *Milano*



Piani cottura Milanello Gun Metal

| | Caratteristiche | Versione | Sigla | Prezzo € | Disegno Tecnico |
|---|---|---|----------|--------------------------|---|
|  | <p>NEW</p> <p>AISI 304 Gun Metal Griglie in ghisa e coprispartifiamma smaltati. Bruciatori Flat Potenza tot. 10.250 W ausiliario: 1.000 W semirapido: 3x1.750 W doppia corona: 4.000 W</p> <p>Accensione elettrica</p> <p>Valvolatura di sicurezza con termocoppia ad intervento rapido</p> |  FT | 7682 006 | <p>€ 1.962,00</p> | <p>Filtop: 803x513 - foro (FT): vedi sito web foro filotop in appoggio (FTS): 790x500</p>  |
| | |  FTS | 7682 006 | | |
| Accessori: 2 (vedi pag. 218) | | | | | |
|  | <p>AISI 304 Gun Metal Griglie in ghisa e coprispartifiamma smaltati Potenza tot. 10.750 W ausiliario: 1.000 W semirapido: 1.750 W</p> <p>rapido: 3.000 W dual: 5.000 W Accensione elettrica Valvolatura di sicurezza con termocoppia ad intervento rapido</p> |  FT | 7681 006 | <p>€ 2.882,00</p> | <p>Filtop: 1115x476 - foro (FT): vedi sito web foro filotop in appoggio (FTS): 1098x459</p>  |
| | |  FTS | 7681 006 | | |
| Accessori: 2 (vedi pag. 218) | | | | | |
|  | <p>AISI 304 Gun Metal Griglie in ghisa e coprispartifiamma smaltati Potenza tot. 7.750 W ausiliario: 1.000 W semirapido: 1.750 W</p> <p>dual: 5.000 W Accensione elettrica Valvolatura di sicurezza con termocoppia ad intervento rapido</p> |  FT | 7680 006 | <p>€ 2.632,00</p> | <p>Filtop: 870x476 - foro (FT): vedi sito web foro filotop in appoggio (FTS): 853x459</p>  |
| | |  FTS | 7680 006 | | |
| Accessori: 2 (vedi pag. 218) | | | | | |

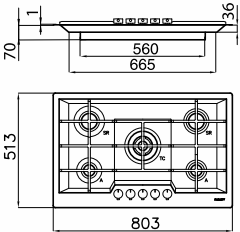
Piani cottura KE Gun Metal

| Caratteristiche | Versione | Sigla | Prezzo € | Disegno Tecnico |
|---|---|----------|--------------------------|--|
|  <p>AISI 304 Gun Metal Griglie in ghisa, bruciatori gun metal e coprispartifiamma smaltati Potenza tot. 9.500 W ausiliario: 2x1.100 W semirapido: 2x1.750 W tripla corona: 3.800 W</p> <p>Accensione elettrica</p> <p>Valvolatura di sicurezza con termocoppia ad intervento rapido</p> |  FT | 7601 632 | <p>€ 1.934,00</p> | <p>Filtop: 803x513 - foro (FT): vedi sito web foro filtop in appoggio (FTS): 790x500</p>  |
| |  FTS | 7601 632 | | |

Accessori: **2** (vedi pag. 218)



PVD Copper Collection









Caldo con sfumature retrò.

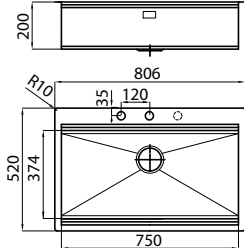

PVD Copper Collections

Lavelli Milanello Copper

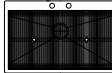
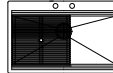
NEW

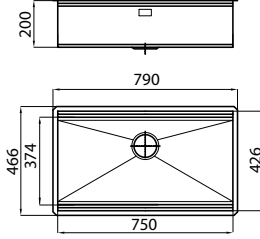
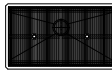
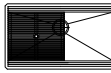
| | Caratteristiche | Versione | Sigla | Prezzo € | Disegno Tecnico |
|---|--|--|---|------------------------|---|
| Base 80  | AISI 304 Copper dimensioni: 806x520 vasca: 750x374 incasso FT: vedi sito web incasso FTS: 789x503 piletta: automatica tipo Space Push (PB) 3½" |  FT | 1034 058 | € 2.585,00 |  |
| | |  FTS | 1034 058 | | |
| In dotazione: 2 griglie Black Milanello (8100 602) | | | | | |
| Accessori opzionali: Z3 T8 M7 L3 L4 N3 N2 P2 T T2 Z Z2 | | | | | |
| | |  Configurazione griglie Black a filo vasca |  Configurazione griglie Black su fondo vasca | possibilità terzo foro | |
| Base 90  | AISI 304 Copper vasca: 750x374 dimensioni: 790x466 incasso: v. sito web piletta: 3½" Copper |  ST | 1034 858 | € 2.304,00 |  |
| | | In dotazione: 2 griglie Black Milanello (8100 602) | | | |
| Accessori opzionali: Z3 T8 L3 L4 M7 N3 N2 P2 T T2 Z Z2 | | | | | |
| Pilette autom.: PB (pag. 148-149) | | | | | |
| | |  Configurazione griglie Black a filo vasca |  Configurazione griglie Black su fondo vasca | | |

In dotazione

Dotazioni Standard: ganci di fissaggio, guarnizione (no per sottotop), piletta, troppopieno e sifone. Imballo in scatola di cartone.



n. 2 griglie Black Milanello

Accessori

accessori opzionali scorrevoli sotto le griglie



Z3
Vaschetta forata
inox 21,5x40 cm
8156 000
€ 274,00



T8
Griglia portapiatti
inox 21,4x37,2 cm
8100 306
€ 80,00

altri accessori opzionali



L3
Tagliere Twin
41x41 cm
8644 004
€ 242,00



L4
Tagliere cristallo
23x41 cm
8631 300
€ 96,00



M7
Tagliere legno noce
15,8x42,4 cm
8642 003
€ 83,00



N2
Tagliere in HDPE
27,2x42,5 cm
8657 001
€ 74,00



N3
Tagliere Twin
inox 21,4x37,9 cm
8644 101
€ 109,00



P2 **
Kit grattugie con
anello-supporto e
vaschetta vivande
8159 101
€ 146,00



T *
Griglia portapiatti
inox 25x35 cm
8100 154
€ 69,00



T2 **
Cestello portapiatti
inox 21,4x37,9 cm
8100 303
€ 93,00



Z *
Scolapasta inox
25x36 cm
8154 000
€ 187,00













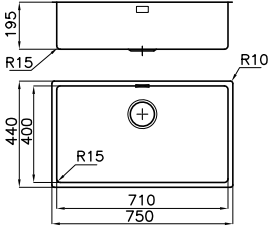

Z2 **
Vaschetta forata
inox 21,5x38 cm
8151 000
€ 279,00

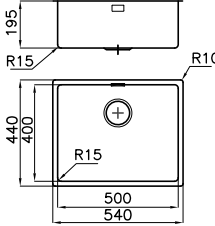
*utilizzabile solo in abbinamento al tagliere L3 **utilizzabile solo in abbinamento al tagliere N3



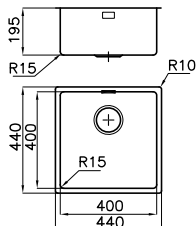









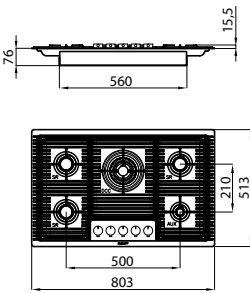

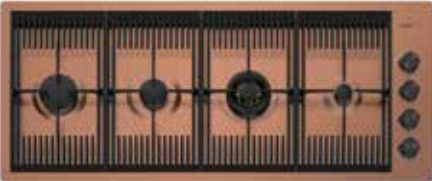
Lavelli KE Copper e Copper Vintage

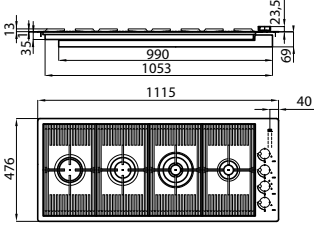
| | | Versione | Sigla | Prezzo € | Disegno Tecnico |
|--|--|--|--|------------|---|
| Base 80  | AISI 304 Copper vasca: 71x40 cm dimensioni: 750x440 incasso: vedi sito web piletta: 3½ |  ST | 2157 858 | € 1.188,00 |  |
| | | versione Copper Vintage  |  ST | 2157 888 | |
| Accessori (v. pag. 19): L3 L4 N2 N3 O2 P2 P4 S T T1 T2 Z Z2 Pilette autom.: PB (pag. 148-149) | | | | | |
| Base 60  | AISI 304 Copper vasca: 50x40 cm dimensioni: 544x444 incasso: vedi sito web piletta: 3½ |  ST | 2155 858 | € 903,00 |  |
| | | versione Copper Vintage  |  ST | 2155 888 | |
| Accessori (v. pag. 19): L3 L4 N2 N3 O2 P2 P4 S T T1 T2 Z Z2 Pilette autom.: PB (pag. 148-149) | | | | | |
| Base 45  | AISI 304 Copper vasca: 40x40 cm dimensioni: 440x440 incasso: vedi sito web piletta: 3½ |  ST | 2156 858 | € 825,00 |  |
| | | versione Copper Vintage  |  ST | 2156 888 | |
| Accessori (v. pag. 19): L3 L4 N2 N3 O2 P2 P4 S T T1 T2 Z Z2 Pilette autom.: PB (pag. 148-149) | | | | | |



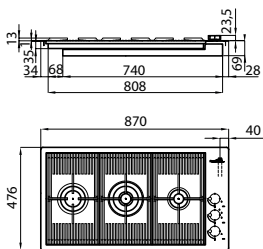

PVD Copper Collections

Piani gas Milanello Copper NEW

| | Caratteristiche | Versione | Sigla | Prezzo € | Disegno Tecnico |
|---|---|---|----------|-------------------|--|
|  | AISI 304 Copper Griglie in ghisa e coprispartifiamma smaltati. Bruciatori Flat Potenza tot. 10.250 W ausiliario: 1.000 W semirapido: 3x1.750 W doppia corona: 4.000 W Accensione elettrica Valvolatura di sicurezza con termocoppia ad intervento rapido |  FT | 7682 008 | € 1.962,00 | Filotop: 803x513 - foro (FT): vedi sito web foro filotop in appoggio (FTS): 790x500  |
| | |  FTS | 7682 008 | | |
| Accessori: 2 (vedi pag. 218) | | | | | |
|  | AISI 304 Copper Griglie in ghisa e coprispartifiamma smaltati Potenza tot. 10.750 W ausiliario: 1.000 W semirapido: 1.750 W rapido: 3.000 W dual: 5.000 W Accensione elettrica Valvolatura di sicurezza con termocoppia ad intervento rapido |  FT | 7681 008 | € 2.882,00 | Filotop: 1115x476 - foro (FT): vedi sito web foro filotop in appoggio (FTS): 1098x459  |
| | |  FTS | 7681 008 | | |
| Accessori: 2 (vedi pag. 218) | | | | | |
|  | AISI 304 Copper Griglie in ghisa e coprispartifiamma smaltati Potenza tot. 7.750 W ausiliario: 1.000 W semirapido: 1.750 W dual: 5.000 W Accensione elettrica Valvolatura di sicurezza con termocoppia ad intervento rapido |  FT | 7680 008 | € 2.632,00 | Filotop: 870x476 - foro (FT): vedi sito web foro filotop in appoggio (FTS): 853x459  |
| | |  FTS | 7680 008 | | |
| Accessori: 2 (vedi pag. 218) | | | | | |

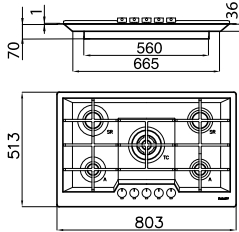

Piano gas KE Copper

| Caratteristiche | Versione | Sigla | Prezzo € | Disegno Tecnico |
|--|---|----------|-------------------|--|
|  <p>AISI 304 Copper Griglie in ghisa, bruciatori gun metal e coprispartifiamma smaltati Potenza tot. 9.500 W ausiliario: 2x1.100 W semirapido: 2x1.750 W tripla corona: 3.800 W</p> <p>Accensione elettrica</p> <p>Valvolatura di sicurezza con termocoppia ad intervento rapido</p> |  FT | 7601 866 | <p>€ 1.934,00</p> | <p>Filotop: 803x513 - foro (FT): vedi sito web foro filotop in appoggio (FTS): 790x500</p>  |
| |  FTS | 7601 866 | | |

Accessori: **2** (vedi pag. 218)

Miscelatori e Complementi Copper

Omega Copper

Miscelatore monocomando con canna girevole (v. pag. 182).



Sigla
8497 400
copper

Prezzo €
€ 572,00

Portaprese Reverse Copper

Slot portaprese push in acciaio inox PVD Copper per incasso su piani da lavoro (v. pag. 154).



Sigla
8000 118
copper

Prezzo €
€ 528,00

PVD Gold Collection









Nobile e di carattere.

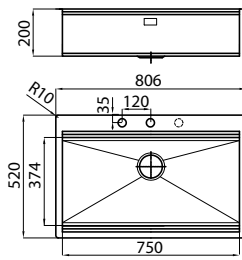

PVD Gold Collections

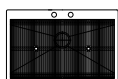
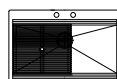
Lavelli Milanello Gold NEW

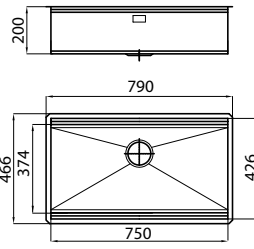
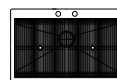
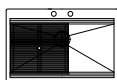
| | Caratteristiche | Versione | Sigla | Prezzo € | Disegno Tecnico |
|---|--|--|---|------------------------|---|
| Base 80  | AISI 304 Gold dimensioni: 806x520 1 vasca: 750x374 incasso FT: vedi sito web incasso FTS: 789x503 piletta: automatica tipo Space Push (PD) 3½" |  FT | 1034 059 | € 2.585,00 |  |
| | |  FTS | 1034 059 | | |
| In dotazione: 2 griglie Black Milanello (8100 602) | | | | | |
| Accessori opzionali: Z3 T8 M7 L3 L4 N3 N2 P2 T T2 Z Z2 | | | | | |
| | |  Configurazione griglie Black a filo vasca |  Configurazione griglie Black su fondo vasca | possibilità terzo foro | |
| Base 90  | AISI 304 Gold vasca: 750x374 dimensioni: 790x466 incasso: v. sito web piletta: 3½" Gold |  ST | 1034 859 | € 2.304,00 |  |
| | | | | | |
| In dotazione: 2 griglie Black Milanello (8100 602) | | | | | |
| Accessori opzionali: Z3 T8 L3 L4 M7 N3 N2 P2 T T2 Z Z2 | | | | | |
| Pilette autom.: PD (pag. 148-149) | | | | | |
| | |  Configurazione griglie Black a filo vasca |  Configurazione griglie Black su fondo vasca | | |

In dotazione

Dotazioni Standard: ganci di fissaggio, guarnizione (no per sottotop), piletta, troppopieno e sifone. Imballo in scatola di cartone.



n. 2 griglie Black Milanello

Accessori

accessori opzionali scorrevoli sotto le griglie



Z3
Vaschetta forata
inox 21,5x40 cm
8156 000
€ 274,00



T8
Griglia portapiatti
inox 21,4x37,2 cm
8100 306
€ 80,00

altri accessori opzionali



L3
Tagliere Twin
41x41 cm
8644 004
€ 242,00



L4
Tagliere cristallo
23x41 cm
8631 300
€ 96,00



M7
Tagliere legno noce
15,8x42,4 cm
8642 003
€ 83,00



N2
Tagliere in HDPE
27,2x42,5 cm
8657 001
€ 74,00



N3
Tagliere Twin
in HDPE 31,7x42,5
8644 101
€ 109,00



P2 **
Kit grattugie con
anello-supporto e
vaschetta vivande
8159 101
€ 146,00



T *
Griglia portapiatti
inox 25x35 cm
8100 154
€ 69,00



T2 **
Cestello portapiatti
inox 21,4x37,9 cm
8100 303
€ 93,00



Z *
Scolapasta inox
25x36 cm
8154 000
€ 187,00







Z2 **
Vaschetta forata
inox 21,5x38 cm
8151 000
€ 279,00

*utilizzabile solo in abbinamento al tagliere L3 **utilizzabile solo in abbinamento al tagliere N3



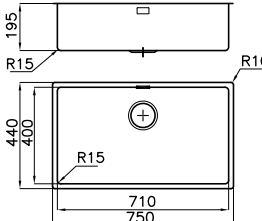

Lavelli KE Gold

| | Caratteristiche | Versione | Sigla | Prezzo € | Disegno Tecnico |
|--|---|--|--|------------|--|
| Base 80  | AISI 304 Gold vasca: 71x40 cm dimensioni: 750x440 incasso: vedi sito web piletta: 3½ |  ST | 2157 859 | € 1.188,00 |  |
| | | versione Gold Vintage  |  ST | 2157 889 | |

Accessori (vedi pag. 19):

L3 L4 N2 N3 O2 P2 P4 S T T1 T2 Z Z2

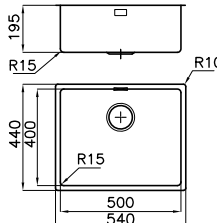



Pilette autom.: PD (pag. 148-149)

| | | | | | |
|--|---|--|--|----------|---|
| Base 60  | AISI 304 Gold vasca: 50x40 cm dimensioni: 544x444 incasso: vedi sito web piletta: 3½ |  ST | 2155 859 | € 903,00 |  |
| | | versione Gold Vintage  |  ST | 2155 889 | |

Accessori (vedi pag. 19):

L3 L4 N2 N3 O2 P2 P4 S T T1 T2 Z Z2

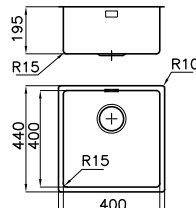
Pilette autom.: PD (pag. 148-149)

| | | | | | |
|--|---|--|--|----------|---|
| Base 45  | AISI 304 Gold vasca: 40x40 cm dimensioni: 440x440 incasso: vedi sito web piletta: 3½ |  ST | 2156 859 | € 825,00 |  |
| | | versione Gold Vintage  |  ST | 2156 889 | |











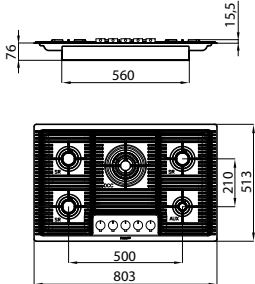

Accessori (vedi pag. 19):

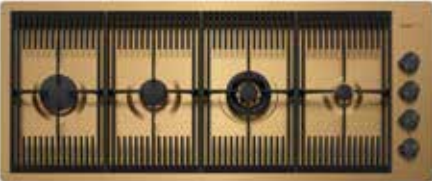
L3 L4 N2 N3 O2 P2 P4 S T T1 T2 Z Z2

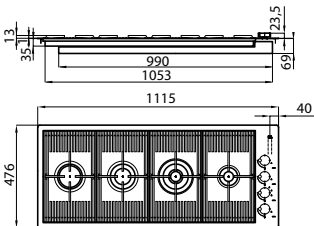
Pilette autom.: PD (pag. 148-149)



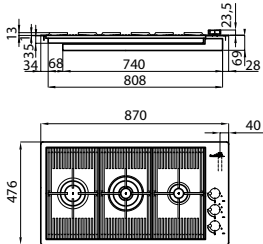

PVD Gold Collections

Piani gas Milanello Gold NEW

| | Caratteristiche | Versione | Sigla | Prezzo € | Disegno Tecnico |
|---|---|---|----------|-------------------|--|
|  | AISI 304 Gold Griglie in ghisa e coprispartifiamma smaltati. Bruciatori Flat Potenza tot. 10.250 W ausiliario: 1.000 W semirapido: 3x1.750 W doppia corona: 4.000 W Accensione elettrica Valvolatura di sicurezza con termocoppia ad intervento rapido |  FT | 7682 009 | € 1.962,00 | Filotop: 803x513 - foro (FT): vedi sito web foro filotop in appoggio (FTS): 790x500  |
| | |  FTS | 7682 009 | | |
| Accessori: 2 (vedi pag. 218) | | | | | |
|  | AISI 304 Gold Griglie in ghisa e coprispartifiamma smaltati Potenza tot. 10.750 W ausiliario: 1.000 W semirapido: 1.750 W rapido: 3.000 W dual: 5.000 W Accensione elettrica Valvolatura di sicurezza con termocoppia ad intervento rapido |  FT | 7681 009 | € 2.882,00 | Filotop: 1115x476 - foro (FT): vedi sito web foro filotop in appoggio (FTS): 1098x459  |
| | |  FTS | 7681 009 | | |
| Accessori: 2 (vedi pag. 218) | | | | | |
|  | AISI 304 Gold Griglie in ghisa e coprispartifiamma smaltati Potenza tot. 7.750 W ausiliario: 1.000 W semirapido: 1.750 W dual: 5.000 W Accensione elettrica Valvolatura di sicurezza con termocoppia ad intervento rapido |  FT | 7680 009 | € 2.632,00 | Filotop: 870x476 - foro (FT): vedi sito web foro filotop in appoggio (FTS): 853x459  |
| | |  FTS | 7680 009 | | |
| Accessori: 2 (vedi pag. 218) | | | | | |

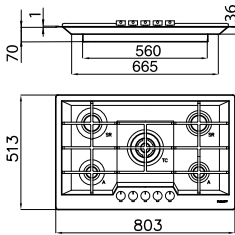

Piano gas KE Gold

| Caratteristiche | Versione | Sigla | Prezzo € | Disegno Tecnico |
|--|---|----------|--------------------------|--|
|  <p>AISI 304 Gold Griglie in ghisa bruciatori gun metal e coprispartifiamma smaltati Potenza tot. 9.500 W ausiliario: 2x1.100 W semirapido: 2x1.750 W tripla corona: 3.800 W</p> <p>Accensione elettrica</p> <p>Valvolatura di sicurezza con termocoppia ad intervento rapido</p> |  FT | 7601 932 | <p>€ 1.934,00</p> | <p>Filopot: 803x513 - foro (FT): vedi sito web foro filopot in appoggio (FTS): 790x500</p>  |
| |  FTS | 7601 932 | | |

Accessori: **2** (vedi pag. 218)

Miscelatori e Complementi Gold

Omega Gold

Miscelatore monocomando con canna girevole (v. pag. 182).



Sigla
8497 700
gold

Prezzo €
€ 572,00

Portaprese Reverse Gold

Slot portaprese push in acciaio inox PVD Gold per incasso su piani da lavoro (v. pag. 154).

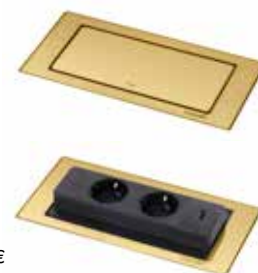

Sigla
8000 119
gold

Prezzo €
€ 528,00

Vintage Collection

Una superficie
d'acciaio che non teme
graffi e scalfitture.

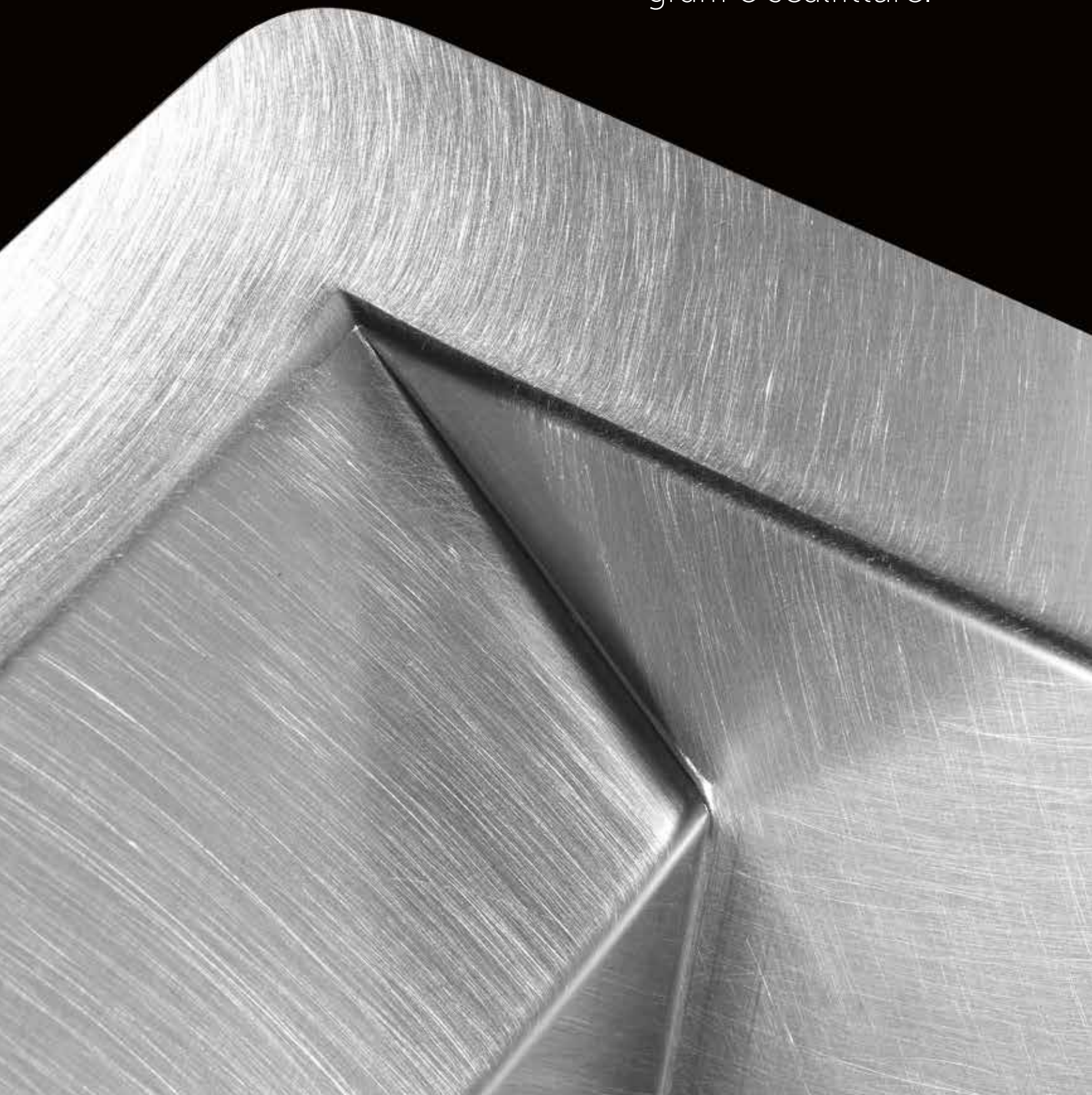

L'acciaio vissuto

Vintage è un'esclusiva finitura Foster caratterizzata dalla particolare spazzolatura asimmetrica che simula i segni del tempo.

Una lavorazione ottenuta totalmente in modo artigianale che viene proposta in una vasta gamma di modelli per darvi la libertà di molteplici suggestivi abbinamenti.

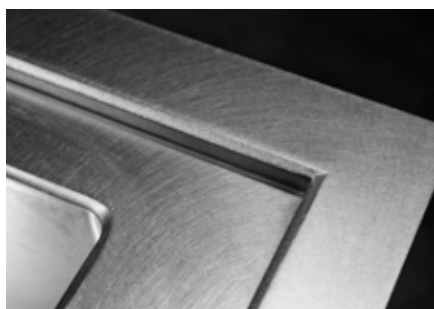





La finitura Vintage è disponibile per lavelli, piani cottura, forni e piani di lavoro, per poter caratterizzare in modo completo il vostro ambiente cucina.



La finitura Vintage è anche proposta abbinata alle sofisticate colorazioni PVD. Scopri la gamma alla sezione Collezioni PVD.



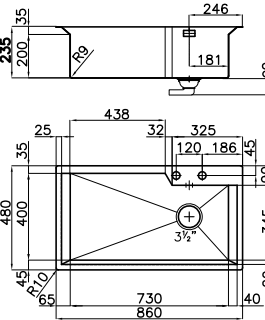







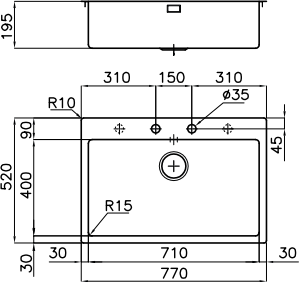

Vintage Collections

Lavelli GK Vintage

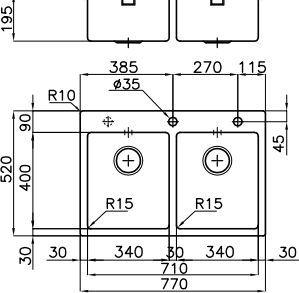
| | Caratteristiche | Versione | Sigla | Prezzo € | Disegno Tecnico |
|---|--|---|----------|-------------------|---|
| Base 90  | AISI 304 vintage vasca: 63x40 cm dimensioni: 740x450 incasso: vedi sito web piletta: SPACE 3½" |  FT | 1402 080 | € 1.412,00 |  |
| | |  FTS | 1402 080 | | |
| modello integrabile nei top in acciaio inox | | | | | |
| In dotazione: PA (v. pag. 148) Accessori opzionali: M4 N4 T2 P2 Z2 | | | | | |

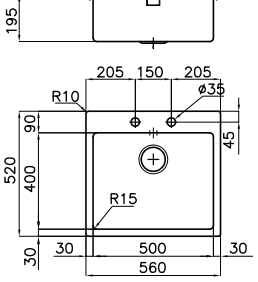

Dotazioni Standard: ganci di fissaggio, guarnizione (no per sottotop), piletta, troppol/pieno e sifone. Imballo in scatola di cartone.

Lavelli KE filotop Vintage

| | Caratteristiche | Versione | Sigla | Prezzo € | Disegno Tecnico |
|---|--|---|----------|-----------------|---|
| Base 80  | AISI 304 Vintage dimensioni: 770x520 1 vasca: 710x400 incasso FT: vedi sito web incasso FTS: 758x508 piletta: autom. 3½" PM |  FT | 2266 080 | € 888,00 |  |
| | |  FTS | 2266 080 | | |
| Accessori: L3 L4 N2 N3 O2 P2 P4 S T T1 T2 Z Z2 | | | | | |
| Possibilità terzo e quarto foro | | | | | |
| Base 80  | AISI 304 Vintage dimensioni: 770x520 2 vasche: 340x400 incasso FT: vedi sito web incasso FTS: 758x508 piletta: autom. 3½" PM |  FT | 2269 080 | € 979,00 |  |
| | |  FTS | 2269 080 | | |
| Accessori: N2 N3 O2 P2 P4 R T1 T2 Z2 | | | | | |
| Possibilità terzo e quarto foro | | | | | |
| Base 60  | AISI 304 Vintage dimensioni: 560x520 1 vasca: 500x400 incasso FT: vedi sito web incasso FTS: 548x508 piletta: autom. 3½" PM |  FT | 2265 080 | € 743,00 |  |
| | |  FTS | 2265 080 | | |
| Accessori: L3 L4 N2 N3 O2 P2 P4 S T T1 T2 Z Z2 | | | | | |

Dotazioni Standard: ganci di fissaggio, guarnizione (no per sottotop), piletta, troppol/pieno e sifone. Imballo in scatola di cartone.

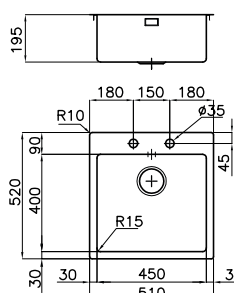
Lavelli KE filotop Vintage

















| | Caratteristiche | Versione | Sigla | Prezzo € | Disegno Tecnico |
|----------------|--|---|----------|-----------------|---|
| Base 60 | AISI 304 Vintage dimensioni: 510x520 1 vasca: 450x400 incasso FT: vedi sito web incasso FTS: 498x508 piletta: autom. 3½" PM |  | 2264 080 | € 719,00 |  |
| | |  | 2264 080 | | |



Accessori: **L3 L4 N2 N3 O2 P2 P4 S T T1**
T2 Z Z2

Dotazioni Standard: ganci di fissaggio, guarnizione (no per sottotop), piletta, troppol/pieno e sifone. Imballo in scatola di cartone.









accessori

| | | | |
|---|---|---|---|
|  L3 Tagliere Twin 41x41 cm 8644 004 € 242,00 |  M Tagliere scorrevole 30x54 cm 8643 000 € 114,00 |  M4 Tagliere scorrevole Iroko 8656 001 € 110,00 |  N2 Tagliere in HDPE 27,2x42,5 cm 8657 001 € 74,00 |
|  N3 Tagliere Twin in HDPE 31,7x42,5 cm 8644 101 € 109,00 |  N4 Tagliere Twin in HDPE 8644 100 € 121,00 |  O2 Vaschetta bianca 27,2x41,4 cm 8153 100 € 39,00 |  P2 ** Kit grattugie con anello-supporto e vaschetta raccogli vivande - 8159 101 € 146,00 |
|  P4 Kit tagliere con vaschetta scolapasta in acciaio inox 8644 044 € 278,00 |  R Cestello Inox 34x40 cm 8611 000 € 50,00 |  S Cestello Inox 40x40 8612 000 € 58,00 Cestello bianco 40x40 8612 100 € 37,00 |  T * Griglia portapiatti 25x35 cm 8100 154 € 69,00 |
|  T1 Cestello portapiatti 25x42,5 cm 8100 201 € 87,00 |  T2 ** Cestello portapiatti inox 21,4x37,9 cm 8100 303 € 93,00 |  Z * Scolapasta inox 25x36 cm 8154 000 € 187,00 |  Z2 ** Vaschetta forata inox 21,5x38 cm 8151 000 € 279,00 |

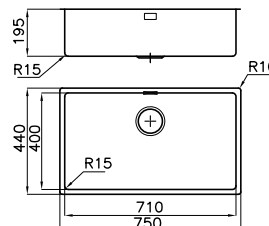
*utilizzabile solo in abbinamento al tagliere L3 **utilizzabile solo in abbinamento al tagliere N3



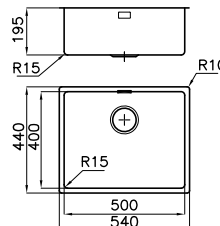

Vintage Collections

Vasche KE filotop Vintage

| | Caratteristiche | Versione | Sigla | Prezzo € | Disegno Tecnico |
|---|---|---|----------|-----------------|---|
| NEW Base 80  | AISI 304 Vintage dimensioni: 750x440 1 vasca: 710x400 incasso FT: v. sito web* incasso FTS: 730x420* piletta: 3½" |  FT | 2157 080 | € 905,00 |  |
| | |  FTS | 2157 080 | | |
| Accessori: L3 L4 N2 N3 O2 P2 P4 S T T1 T2 Z Z2 Pilette automatiche: PA PE PM PL PP PS (v. pag. 148-149) | * il foro incasso necessita di intaglio per l'alloggio del troppo-pieno (vedi sito web) | | | | |
| Base 60  | AISI 304 Vintage dimensioni: 540x440 1 vasca: 500x400 incasso FT: v. sito web* incasso FTS: 520x420* piletta: 3½" |  FT | 2155 080 | € 662,00 |  |
| | |  FTS | 2155 080 | | |
| Accessori: L3 L4 N2 N3 O2 P2 P4 S T T1 T2 Z Z2 Pilette automatiche: PA PE PM PL PP PS (v. pag. 148-149) | * il foro incasso necessita di intaglio per l'alloggio del troppo-pieno (vedi sito web) | | | | |

Dotazioni Standard: ganci di fissaggio, guarnizione (no per sottotop), piletta, troppo/pieno e sifone. Imballo in scatola di cartone.

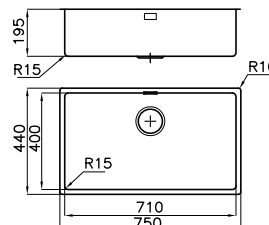
Vasche KE sottotop Vintage

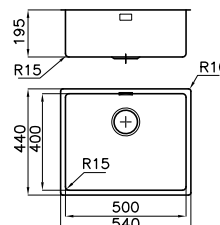
| | Caratteristiche | Versione | Sigla | Prezzo € | Disegno Tecnico |
|--|---|--|----------|-----------------|---|
| NEW Base 80  | AISI 304 Vintage vasca: 71x40 cm dimensioni: 750x440 incasso: vedi sito web piletta: 3½ |  ST | 2157 880 | € 742,00 |  |
| | | | | | |
| Accessori: L3 L4 N2 N3 O2 P2 P4 S T T1 T2 Z Z2 Pilette autom.: PA PE PM PL PP PS (v. pag. 148-149) | | | | | |
| Base 60  | AISI 304 Vintage vasca: 50x40 cm dimensioni: 544x444 incasso: vedi sito web piletta: 3½ |  ST | 2155 880 | € 557,00 |  |
| | | | | | |
| Accessori: L3 L4 N2 N3 O2 P2 P4 S T T1 T2 Z Z2 Pilette autom.: PA PE PM PL PP PS (v. pag. 148-149) | | | | | |

Dotazioni Standard: ganci di fissaggio, guarnizione (no per sottotop), piletta, troppo/pieno e sifone. Imballo in scatola di cartone.

Vasche KE sottotop Vintage

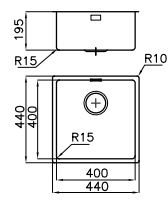
| | Caratteristiche | Versione | Sigla | Prezzo € | Disegno Tecnico |
|----------------|---|---|----------|-----------------|---|
| Base 45 | AISI 304 Vintage vasca: 40x40 cm dimensioni: 440x440 incasso: vedi sito web piletta: 3½ |  ST | 2156 880 | € 496,00 |  |



Accessori:



L3 L4 N2 N3 O2 P2 P4 S T T1 T2 Z Z2

Pilette autom.: **PA PE PM PL PP PS**

(v. pag. 148-149)

Dotazioni Standard: ganci di fissaggio, guarnizione (no per sottotop), piletta, troppo/pieno e sifone. Imballo in scatola di cartone.





accessori

| | | | | | |
|---|--|---|---|---|---|
|  | L3 Tagliere Twin 41x41 cm 8644 004 € 242,00 |  | L4 Tagliere cristallo 23x41 cm 8631 300 € 96,00 |  | M Tagliere scorrevole 30x54 cm 8643 000 € 114,00 |
|  | N2 Tagliere in HDPE 27,2x42,5 cm 8657 001 € 74,00 |  | N3 Tagliere Twin in HDPE 31,7x42,5 cm 8644 101 € 109,00 |  | O2 Vaschetta bianca 27,2x41,4 cm 8153 100 € 39,00 |
|  | P2 ** Kit grattugie con anello-supporto e vaschetta raccogli vivande 8159 101 € 146,00 |  | P4 Kit tagliere con vaschetta scolapasta in acciaio inox 8644 044 € 278,00 |  | R Cestello Inox 34x40 cm 8611 000 € 50,00 |
|  | S Cestello Inox 40x40 8612 000 € 58,00 Cestello bianco 40x40 8612 100 € 37,00 |  | T * Griglia portapiatti 25x35 cm 8100 154 € 69,00 |  | T1 Cestello portapiatti 25x42,5 cm 8100 201 € 87,00 |
|  | T2 ** Cestello portapiatti inox 21,4x37,9 cm 8100 303 € 93,00 |  | Z * Scolapasta inox 25x36 cm 8154 000 € 187,00 |  | Z2 ** Vaschetta forata inox 21,5x38 cm 8151 000 € 279,00 |

*utilizzabile solo in abbinamento al tagliere L3 **utilizzabile solo in abbinamento al tagliere N3



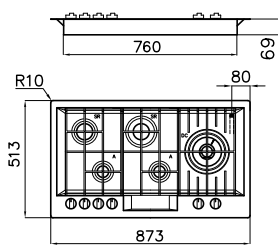

Vintage Collections

Piano a gas FL Vintage

| | Caratteristiche | Versione | Sigla | Prezzo € | Disegno Tecnico |
|---|--|---|----------|-------------------|---|
|  | AISI 304 Vintage Griglie in ghisa e coprispartifiamma smaltati Potenza tot. 10.500 W ausiliario: 2x1.000 W dual AE: 5.000 W semirapido: 2x1.750 W Accensione elettrica Valvolatura di sicurezza con termocoppia ad intervento rapido |  FT | 7206 082 | € 1.477,00 | Filotop: 873x513 - foro (FT): vedi sito web foro filotop in appoggio (FTS): 860x500  |
| | |  FTS | 7206 082 | | |

Accessori: **2** (vedi pag. 218)

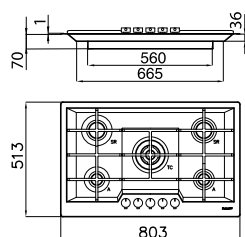
Piano a gas KE Black Vintage

| | Caratteristiche | Versione | Sigla | Prezzo € | Disegno Tecnico |
|--|---|--|----------|-------------------|--|
|  | AISI 304 Vintage Griglie in ghisa, bruciatori gun metal e coprispartifiamma smaltati Potenza tot. 9.500 W ausiliario: 2x1.100 W semirapido: 2x1.750 W tripla corona: 3.800 W Accensione elettrica Valvolatura di sicurezza con termocoppia ad intervento rapido |  FT | 7601 082 | € 1.382,00 | Filotop: 803x513 - foro (FT): vedi sito web foro filotop in appoggio (FTS): 790x500  |
| | |  FTS | 7601 082 | | |

Accessori: **2** (vedi pag. 218)



Piano cottura **KE Black** con finitura **Vintage**.

Forno FL 90 Vintage

| Modello | Finitura | Sigla | Prezzo € | Disegno Tecnico |
|--|--------------------|----------|------------|--|
| FL Vintage - 90 multifunzione 90x48 - 91 litri | VINTAGE ANTI-TOUCH | 7107 042 | € 1.975,00 | Dotazione di serie: - teglia profonda - griglia inox |



- Forno multifunzione 90x48 cm, volume lordo 91 litri • 10 funzioni di cottura • Display con programmazione elettronica di inizio-fine cottura e comandi push-pull • Maxi-Grill (abbattibile) • 2 guide telescopiche per agevolare l'estrazione delle teglie • Porta: 3 vetri • Finitura maniglia nera • Interno porta Full Glass • Cristallo StopSol • Vetro interno porta removibile • Smaltatura Easy Clean • Protezione resistenza Grill • Ventilazione tangenziale • Illuminazione alogena su entrambe le pareti, attiva all'apertura della porta • Interruttore di contatto della porta
- Classe energetica A
- Alimentazione: 220-240V 50-60Hz

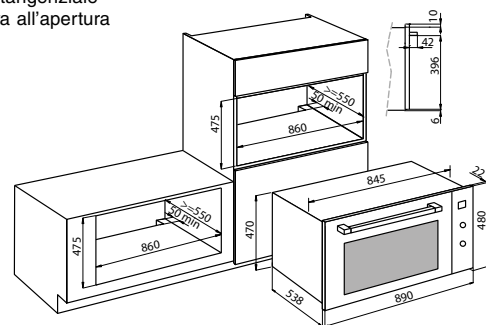

| COTTURA SOTTO | COTTURA TRADIZ. | COTTURA INTENSIVA | COTTURA VENTILATA | GRILL CENTRALE | DOPPIO GRILL | GRILL + COTTURA SOTTO | VENTOLA + MAXI GRILL | VENTOLA + COTTURA SOTTO | SCONGELAMENTO |
|---------------|-----------------|-------------------|-------------------|----------------|--------------|-----------------------|----------------------|-------------------------|---------------|
| | | | | | | | | | |

Complementi Vintage



Portaprese Reverse Vintage

Slot portaprese push in acciaio inox Vintage per incasso su piani da lavoro
- 2 prese Schuko - 1 presa USB per ricarica
Foro incasso: 215x88 mm

| | |
|----------|----------|
| Sigla | Prezzo € |
| 8000 117 | € 448,00 |

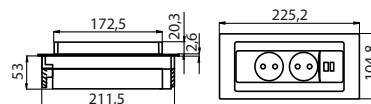



Foster
marine
Collection

Ideale per le
soluzioni al mare



**AISI
316**





Utilizzato nel settore nautico,
garantisce **la migliore resistenza
alla salsedine, ai detersivi, agli
acidi degli alimenti.**



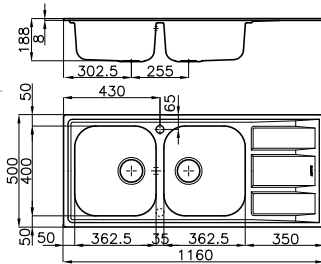

miscelatori consigliati

Lavelli FM Marine

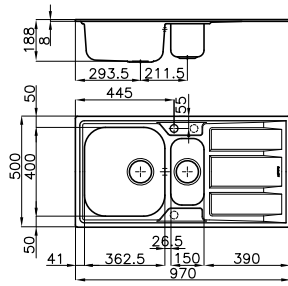
| | Caratteristiche | Versione | Sigla | Prezzo € | Disegno Tecnico |
|---|---|---|------------------------------------|------------------------|---|
| <p>NEW</p> <p>Base 80/(90)^T (rif. pag. 55)</p>  <p><i>In foto versione sinistra</i></p> <p>Accessori: L4 M N2 R T4 Pilette automatiche: PR PC (vedi pag. 149)</p> | <p>AISI 316 spazzolato dimensioni: 1160x500 2 vasche: 362,5x400 incasso: 1140x480 piletta: 3/2"</p> |  | <p>1972 961 dx 1972 962 sx</p> | <p>€ 259,00</p> |  <p>Possibilità secondo foro</p> |
| <p>Base 60/(80)^T (rif. pag. 55)</p>  <p><i>In foto versione sinistra</i></p> <p>Accessori: M N2 Q R T4 X Pilette automatiche: PR PC (vedi pag. 149)</p> | <p>AISI 316 spazzolato dimensioni: 970x500 2v: 362,5x400+150x300 incasso: 950x480 piletta: 3/2"</p> |  | <p>1973 961 dx 1973 962 sx</p> | <p>€ 300,00</p> |  <p>Possibilità secondo e terzo foro</p> |

Dotazioni Standard: ganci di fissaggio, guarnizione (no per sottotop), piletta, troppo/pieno e sifone. Imballo in scatola di cartone.

Lavelli FM Marine

NEW

Base 80(90)^T (rif. pag. 55)



AISI 316 spazzolato
dimensioni: **860x500**
2 vasche: **362,5x400**
incasso: 840x480
piletta: 3½"



1974 960

€ 229,00

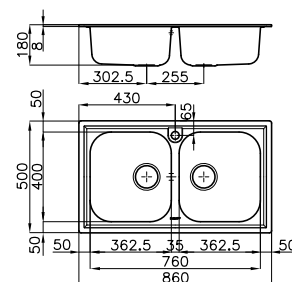
 Accessori: **L4 M N2 R T4**

Base 45



In foto versione sinistra

AISI 316 spazzolato
dimensioni: **860x500**
1 vasca: **362,5x400**
incasso: 840x480
piletta: 3½"



1971 961 dx

1971 962 sx

€ 184,00

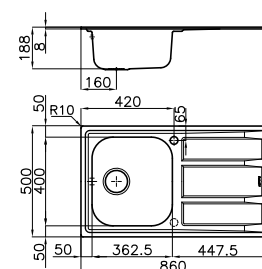

Possibilità secondo foro

 Accessori: **L4 M N2 R T4**

 Pilette automatiche: **PR PC** (vedi pag. 149)

Dotazioni Standard: ganci di fissaggio, guarnizione (no per sottotop), piletta, troppo/pieno e sifone. Imballo in scatola di cartone.

accessori



L4
Tagliere cristallo
23x41 cm
8631 300
€ 96,00



M
Tagliere scorrevole
30x54
8643 000
€ 114,00



N2
Tagliere in HDPE
27,2x42,5 cm
8657 001
€ 74,00



Q
Scolapasta bianco
17x32 cm
8151 100
€ 32,00



R
Cestello Inox
34x40 cm
8611 000
€ 50,00



T4
Griglia portapiatti
inox 25x43 cm
8100 301
€ 87,00



X
Scolapasta inox
17x32 cm
8154 043
€ 146,00



Piano cottura KF Marine

| Caratteristiche | Versione | Sigla | Prezzo € | Disegno Tecnico |
|--|----------------------------|-------|-----------------|--|
| <p>acciaio AISI 316 Griglie in ghisa e coprispartifiamma smaltati Potenza tot. 10.700 W ausiliario: 1.000 W semirapido: 2x1.750 W rapido: 2.700 W tripla corona: 3.500 W</p> <p>Accensione elettrica</p> <p>Valvolatura di sicurezza con termocoppia ad intervento rapido</p> | <p>STD</p> <p>7666 962</p> | | <p>€ 900,00</p> | <p>Dimensioni: 760x500 - foro: 560x480</p> |
| <p>Accessori: 2 (vedi pag. 218)</p> | | | | <p>Modello non integrabile in top inox</p> |



Un piano interamente in **AISI 316**, che garantisce la migliore resistenza agli effetti corrosivi degli acidi, della salsedine e dei detersivi.

Miscelatori Marine - AISI 316

Tube

Miscelatore monocomando con canna girevole e doccia snodabile. In acciaio inox AISI 316.



piastra di rinforzo inclusa
foro per miscelatore: \varnothing 35 mm
base d'appoggio: \varnothing 55 mm
angolo di rotazione: 360°
cartuccia con dischi ceramici
spessore max top: 40 mm
ingombro posteriore per
rotazione comando: 25 mm

Sigla
8477 100
satinato/
nero

Prezzo €
€ 869,00

Skin

Miscelatore monocomando con canna girevole e doccia snodabile.

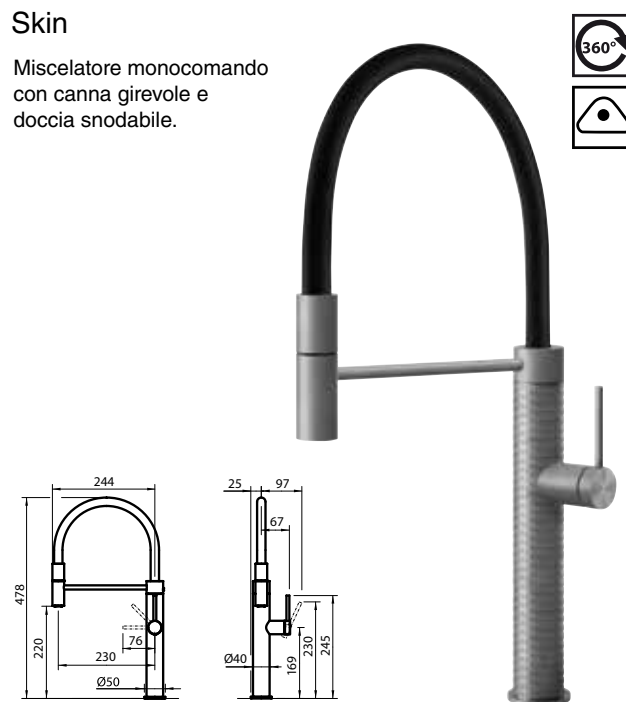

Parti estetiche in acciaio AISI 316
piastra di rinforzo inclusa
foro per miscelatore: \varnothing 35 mm
base d'appoggio: \varnothing 50 mm
angolo di rotazione: 360°
cartuccia con dischi ceramici
spessore max top: 40 mm

Sigla
8424 100
satinato

Prezzo €
€ 1.110,00

Gamma 3 vie

Miscelatore a tre vie con doppio comando e canna girevole. Le tre vie permettono erogazione di acqua calda/fredda e filtrata per uso alimentare. In acciaio inox AISI 316.

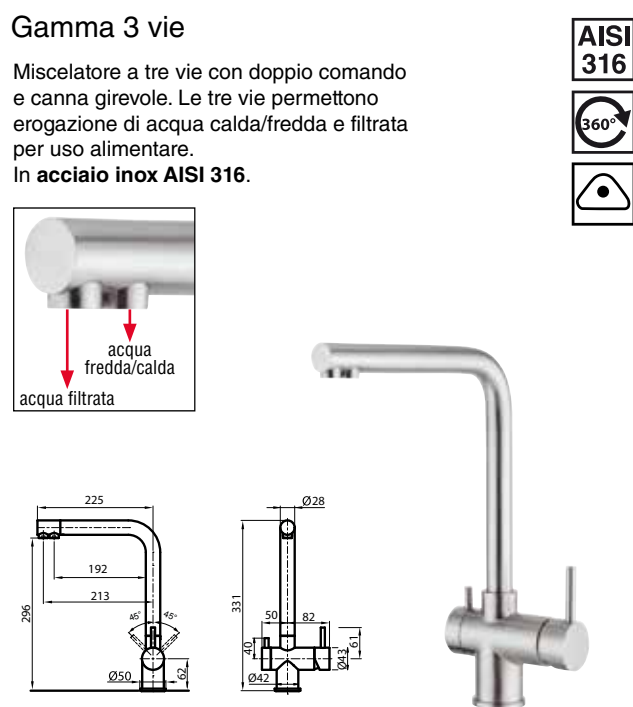

piastra di rinforzo inclusa
foro per miscelatore: \varnothing 35 mm
base d'appoggio: \varnothing 50 mm
angolo di rotazione: 360°
cartuccia con dischi ceramici
spessore max top: 50 mm

Sigla
8496 100
satinato
inox

Prezzo €
€ 633,00

Bert

Miscelatore monocomando con doccia estraibile. In acciaio inox AISI 316.

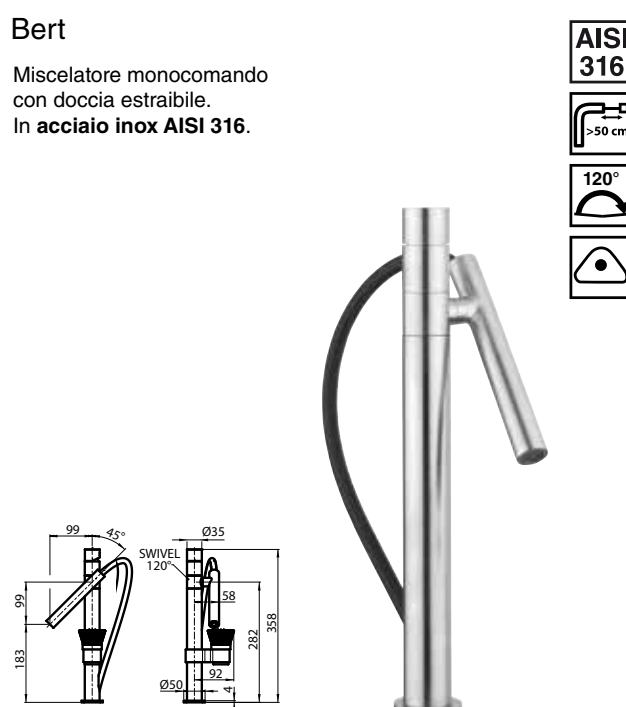

piastra di rinforzo inclusa
foro per miscelatore: \varnothing 35 mm
base d'appoggio: \varnothing 54 mm
angolo di rotazione: 120°
cartuccia con dischi ceramici
spessore max top: 50 mm
spazzola Hydrobrush in dotazione

Sigla
8428 100
satinato
inox

Prezzo €
€ 989,00



LAVELLI

Foster Milano
p. 56



Milanello
Workstation
p. 60



New Wave
p. 66



GK p. 68



S4001
p. 70



S4000
p. 74



Quadra
p. 76



Fortyfour
p. 80



CQ p. 81



Master
p. 82



FL p. 83



KE p. 84



Stripe
p. 90



Triplo Invaso
Workstation
p. 92



EVO p. 94



KS p. 96



Elettra
p. 98



FM
e FM Marine
p. 100



Big Bowl
p. 102



Uragano
p. 104



Tornado
p. 105



Angolare
p. 107



Circolari
p. 108



S1000
p. 109



Monovasca
S1000
p. 111



Lavelli
Sottotop
p. 112



LAVELLI

Finiture firmate Foster

- per coniugare al meglio ESTETICA e FUNZIONALITÀ
- per facilità di PULIZIA e BRILLANTEZZA nel tempo



 Spazzolato
Foster

Finitura spazzolato Foster

Gli acciai sono trattati con particolari fibre vegetali che conferiscono la caratteristica satinatura extrafine, di grande eleganza e funzionalità. **La ridotta rugosità superficiale di questa finitura privilegia la facilità di pulizia.**

Finiture PVD

NEW

Un aspetto tutto nuovo per il classico, esclusivo acciaio AISI 304, grazie all'innovativo trattamento fisico PVD (Physical Vapor Deposition). Questo permette la deposizione di metalli pregiati sulle superfici d'acciaio, **conferendo un'esclusiva colorazione e migliorando la resistenza a graffi e usura.** Disponibile nelle varianti Gun Metal, Gold, Copper.



Finitura Vintage

NEW

Un tocco retrò, assieme alla praticità di una **superficie d'acciaio che non teme graffi e scalfitture.** La spazzolatura asimmetrica ottenuta con metodi artigianali simula i segni del tempo e dona all'acciaio un nuovo ed originale appeal.

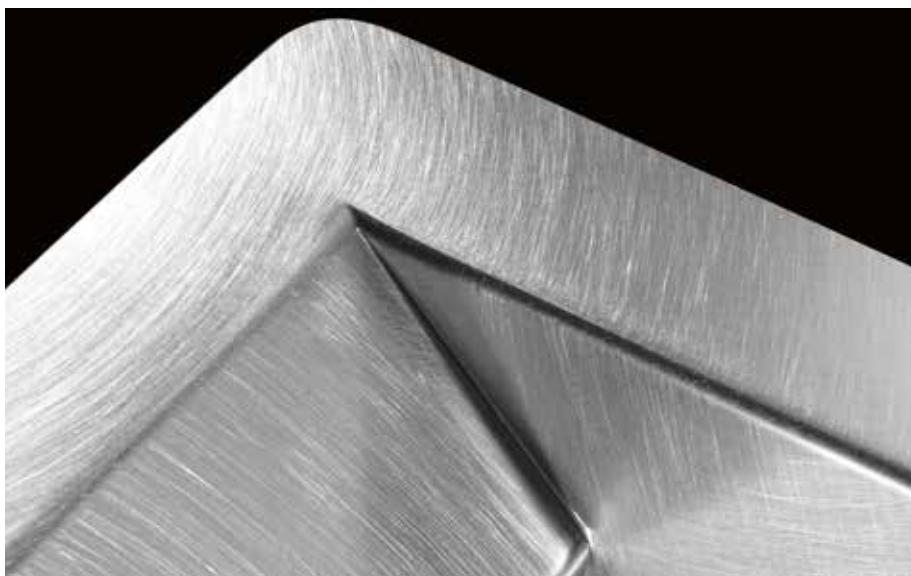

Oltre l'incasso... come e dove vuoi tu

Le modalità di incasso nei piani di lavoro sono sempre più differenziate e personalizzate. Foster è stata la prima produttrice di lavelli ad impegnarsi nei nuovi sistemi di inserimento e oggi vanta una notevole esperienza e la più completa gamma disponibile sul mercato di modelli con inserimento a filo, semifilo e sottotop.



Standard

Tipo di incasso tradizionale con il bordo che sporge di 8 mm sul piano di lavoro.



Q4

Incasso con profilo squadrato ed una minima sporgenza dal piano (4 mm). Soluzione perfetta per gli abbinamenti con i piani in vetroceramica (induzione).



Semifilo

Bordo inclinato che sporge solo 3 mm sul top; si caratterizza per il connubio fra eleganza e facilità di installazione.



Filotop

Si inserisce in un alloggiamento di un millimetro e risulta perfettamente a filo con il piano di lavoro. In alternativa, può essere installato in appoggio al top.



Sottotop

Soluzione elegante ed attuale, è l'installazione del lavello sotto il piano di lavoro.



Integrato

Quasi l'intera collezione di lavelli Foster è integrabile in top inox; la soluzione più elegante e professionale, in modo da costruire un blocco unico senza alcuna discontinuità.

Filotop e Semifilo: una dovuta precisazione

Molti produttori indicano come Semifilo il bordo Filotop inserito in appoggio al piano di lavoro.



Per Foster il Semifilo è una vera e propria soluzione alternativa con l'elegante bordo inclinato con uno spessore di soli 3 mm.



I modelli Filotop di Foster sono comunque anch'essi inseribili in appoggio al piano (come nella foto di dettaglio a fianco) creando un'ulteriore tipologia di incasso.



A ciascuno il proprio lavello



Lavelli di spessore

Lavelli "robusti" dal design unico... Foster utilizza spessori di acciaio superiori a quelli mediamente usati dagli altri produttori.



Vasche capienti

Anche grazie all'evoluta tecnologia produttiva nelle soluzioni mono-stampate le vasche Foster raggiungono profondità importanti, offrendo grande capienza e praticità in tutte le operazioni di lavaggio.



Vasca a raggio stretto

Vasche con forme squadrate dal design moderno e con aumentata capienza. Foster propone una vasta scelta di soluzioni con diverse modalità costruttive e spigoli con differenti raggiature.



Fori miscelatore

L'ampio banco rubinetteria è spesso provvisto di serie di 2 fori rubinetto. Altri sono personalizzabili con l'esecuzione su richiesta di fori aggiuntivi, per miscelatori a doppio foro, pilette con comando remoto o dispenser per il sapone.



Fondo diamantato

Il perfetto scolo è sempre garantito. Nei modelli squadrate a fondo piatto l'elegante diamantatura facilita il defluire dell'acqua.



Pilette di serie

La piletta grande 3,5", con il pratico tappo a cestello, oltre ad impedire il defluire nello scarico di parti solide permette l'utilizzo del dissipatore Foster, compatibile con tutti i modelli. (Non è garantita la compatibilità con dissipatori di altri produttori).



Piletta con comando remoto

La piletta-salterello con comando remoto rotante evita di bagnarsi le mani per svuotare le vasche dall'acqua (vedi pag. 148).



Troppo/Pieno perimetrale





Una sicurezza sempre presente sui lavelli Foster che impedisce il traboccare dell'acqua in caso di dimenticanze. Il nuovo modello a scarico perimetrale migliora l'estetica grazie alla forma squadrate ed essenziale.



Salvaspazio

Più spazio nel sottolavello, importante per le necessità di raccolta differenziata. Di serie su alcune soluzioni, è sempre implementabile grazie a pilette e sifoni ordinabili come accessorio (vedi pag. 148).

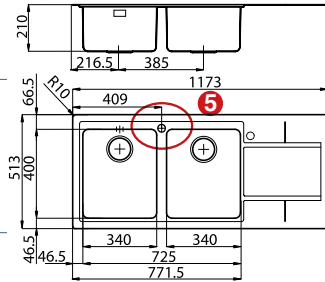
Guida alla lettura del listino

| | Caratteristiche | Versione | Sigla | Prezzo € | Disegno Tecnico |
|---|---|--|---|----------|---|
| <p>Base 80 ²</p>  <p>In foto versione sinistra</p> <p>Accessori: ⁴ L1 L4 N2 N3 O2 P1 P2 R T1 T2 Z2 Solo per bordo Q4: L5 M</p> | AISI 304 spazzolato dimensioni: 1160x500 2 vasche: 340x400 incasso: 1140x480 pileta: 3/2" |  Q4 | 4312 051 ³ dx 4312 052 ³ sx | € 973,00 | Le quote perimetrali si riferiscono alla versione filotop  |
| | | AISI 304 spazzolato dimensioni: 1173x513 2 vasche: 340x400 incasso FT: vedi sito web incasso FTS: 1160x500 pileta: 3/2" |  FT  FTS | | |



1 Tipologie d'incasso

Molti lavelli Foster sono disponibili in più versioni (Incasso Standard, Filotop, Semifilo e Sottotop) che possono presentare dimensioni leggermente diverse tra di loro. Raccomandiamo pertanto di fare riferimento alle specifiche riportate a fianco di ciascuna versione. Sotto al disegno è sempre indicato a quale tipo di incasso si riferiscono le quote.

3 Lavelli destri, sinistri e reversibili

La doppia codifica del singolo modello indica la disponibilità di versione destra e sinistra. Per versione destra (dx) si intende con vasca/e a destra (o vasca maggiore nei modelli senza gocciolatoio). Le versioni sinistre sono contrassegnate con sx. Il codice unico indica che il lavello è reversibile, o disponibile solo come rappresentato in foto e disegno.

accessori

| | | |
|--|---|--|
| <p>A</p>  <p>Tagliere 34x40 8647 000 € 92,00</p> | <p>G</p>  <p>Tagliere 40x40 8646 000 € 110,00</p> | <p>L4</p>  <p>Tagliere cristallo 23x41 cm 8631 300 € 96,00</p> |
|--|---|--|

4 Accessori

Attenta a coniugare estetica e funzionalità, da sempre Foster pone particolare attenzione agli accessori dei propri prodotti. Anche nel presente listino si è voluto dare importanza alle dotazioni opzionali, riportate a piede di ogni serie e riferite ai singoli modelli, per identificare con facilità i corretti abbinamenti.

2 Basi

Per base si intende il più piccolo modulo standard di cucina componibile nel quale può essere inserito il lavello. In alcuni casi è riportata una doppia misura:

(B) per inserimento in top di spessore di almeno 40 mm, considerare la misura minore, indicata tra parentesi. (es. pag. 77);

(T) per inserimento a inizio/fine composizione, considerare la misura maggiore, indicata tra parentesi.

Si rimanda alla conoscenza dei produttori di cucine per inserimenti particolari che richiedono lavorazioni sui mobili.

Nota: le misure delle basi indicate si riferiscono agli ingombri delle vasche e non dei sistemi di fissaggio, che possono cambiare nelle diverse installazioni.

Si rimanda alla conoscenza dei produttori di cucine per inserimenti particolari che richiedono lavorazioni sui mobili.

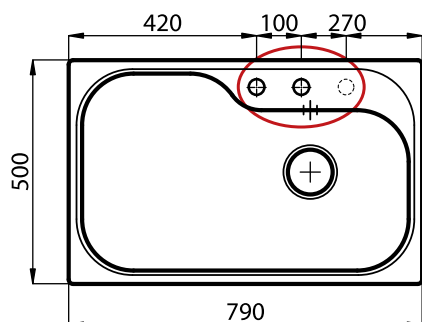
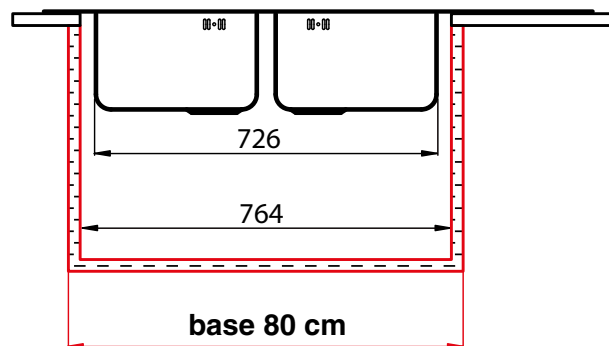

5 Fori miscelatore

Nei disegni sono riportati con tratto continuo i fori rubinetto in dotazione standard. Con tratteggio sottile le posizioni per eventuali altri fori su richiesta per consentire l'immediato inserimento del comando della pileta automatica o di un eventuale dispenser. Per alcuni modelli, la personalizzazione con fori aggiuntivi è eseguita con sovrapprezzo.



Piletta SPACE



T/P perimetrale



Piletta Salva spazio

Foster Milano

UN CONCETTO INNOVATIVO DI FUNZIONALITÀ



Un'ampia vasca squadrata, tutto lo spazio che serve come lavello o area di lavoro.



Il sistema di invasi permette di configurare il lavello in mille modi differenti.



Sugli invasi del lavello possono alloggiare infatti un'infinità di pratici accessori.



Il kit grattugie è un pratico elemento che si inserisce nell'apposito tagliere.



Le pratiche vaschette completano il set di lavoro.



Lo scolapasta in acciaio inox, praticità e igiene.



L'ampia zona di appoggio delle griglie Black affianca tutti gli accessori.



Le griglie si spostano sul fondo, più igiene per il cibo e protezione per la vostra vasca.



Il lavello sparisce all'istante e diventa un'unica superficie di lavoro.



Sistema a tre invasi

Un ingegnoso design, con un sistema di invasi dove gli accessori alloggiavano su livelli distinti. Sul primo scorrono le griglie Black: una grande superficie per risciacquare, scolare, lavorare.



Gamma completa di accessori













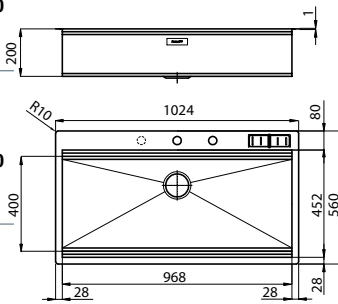

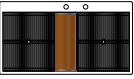
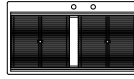

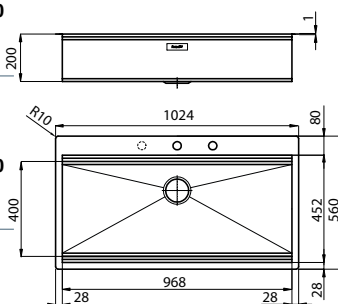

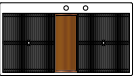
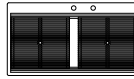

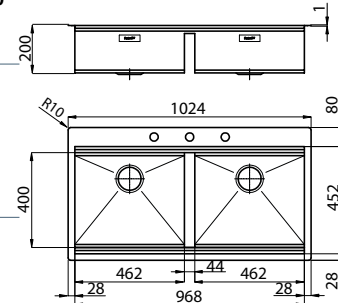
Il secondo invaso è studiato per una combinazione di accessori che rendono pratica ogni operazione: risciacquare, scolare, affettare, grattugiare... sempre all'interno del lavello.

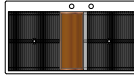



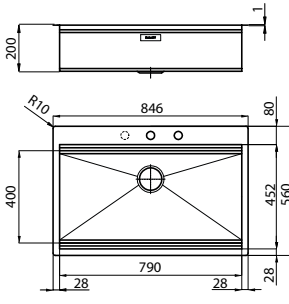

Griglia di protezione sul fondo

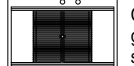
Il terzo invaso è sul fondo della vasca. Su questo alloggiavano le griglie Black per risciacquare senza venire a contatto con il fondo, o per appoggiare senza graffiare l'acciaio.

Foster Milano

| | Caratteristiche | Versione | Sigla | Prezzo € | Disegno Tecnico |
|--|--|---|----------------------|------------|---|
| Base 120  | AISI 304 satinato dimensioni: 1024x560 1 vasca: 968x400 incasso: 1004x540 piletta: automatica tipo Space Milano (PS) 3½" |  Q4 | 1018 055 | € 1.298,00 |  |
| | AISI 304 satinato dimensioni: 1024x560 1 vasca: 968x400 incasso FT: vedi sito web incasso FTS: 1004x540 piletta: automatica tipo Space Milano (PS) 3½" |  FT  FTS | 1017 055 1017 055 | € 1.298,00 | |
| In dotazione: elemento portacoltelli e PS Accessori opzionali: M6 P3 L4 N3 P2 T2 Z2 |  Configurazione griglie Black a filo vasca |  Configurazione griglie Black su fondo vasca | | | possibilità 3° foro |
| Base 120  | AISI 304 satinato dimensioni: 1024x560 1 vasca: 968x400 incasso: 1004x540 piletta: automatica tipo Space Milano (PS) 3½" |  Q4 | 1018 050 | € 1.221,00 |  |
| | AISI 304 satinato dimensioni: 1024x560 1 vasca: 968x400 incasso FT: vedi sito web incasso FTS: 1004x540 piletta: automatica tipo Space Milano (PS) 3½" |  FT  FTS | 1017 050 1017 050 | € 1.221,00 | |
| In dotazione: PS Accessori opzionali: M6 P3 L4 N3 O2 P2 T2 Z2 |  Configurazione griglie Black a filo vasca |  Configurazione griglie Black su fondo vasca | | | possibilità 3° foro |
| Base 120  | AISI 304 satinato dimensioni: 1024x560 2 vasche: 462x400 incasso: 1004x540 piletta: 2 automatiche tipo Space Milano (PS) 3½" |  Q4 | 1020 050 | € 1.732,00 |  |
| | AISI 304 satinato dimensioni: 1024x560 2 vasche: 462x400 incasso FT: vedi sito web incasso FTS: 1004x540 piletta: 2 automatiche tipo Space Milano (PS) 3½" |  FT  FTS | 1019 050 1019 050 | | |
| Articolo ad esaurimento |  Configurazione griglie Black a filo vasca |  Configurazione griglie Black su fondo vasca | | | |
| In dotazione: PS Accessori opzionali: M6 P3 L4 N3 O2 P2 T2 Z2 | | | | | |
| Base 90  | AISI 304 satinato dimensioni: 846x560 1 vasca: 790x400 incasso: 826x540 piletta: automatica tipo Space Milano (PS) 3½" |  Q4 | 1025 050 | € 1.602,00 |  |
| | AISI 304 satinato dimensioni: 846x560 1 vasca: 790x400 incasso FT: vedi sito web incasso FTS: 826x540 piletta: automatica tipo Space Milano (PS) 3½" |  FT  FTS | 1024 050 1024 050 | € 1.602,00 | |
| In dotazione: PS Accessori opzionali: M6 P3 L4 N3 O2 P2 T2 Z2 |  Configurazione griglie Black a filo vasca |  Configurazione griglia Black su fondo vasca | | | possibilità 3° foro |

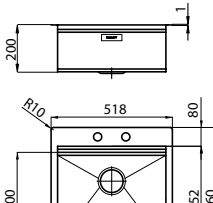
Foster Milano

| | Caratteristiche | Versione | Sigla | Prezzo € | Disegno Tecnico |
|--|---|---|----------|----------|---|
| Base 60  | AISI 304 satinato dimensioni: 518x560 1 vasca: 462x400 incasso: 498x540 piletta: automatica tipo Space Milano (PS) 3½" |  Q4 | 1012 050 | € 950,00 |  |
| | AISI 304 satinato dimensioni: 518x560 1 vasca: 462x400 incasso FT: vedi sito web |  FT | 1011 050 | € 950,00 | |
| | incasso FTS: 498x540 piletta: automatica tipo Space Milano (PS) 3½" |  FTS | 1011 050 | | |

In dotazione: **PS**

Accessori opzionali: **M6 P3 L4 N3 O2 P2 T2 Z2**











Configurazione
griglia Black
a filo vasca



Configurazione
griglia Black
su fondo vasca

Dotazioni Standard: ganci di fissaggio, guarnizione (no per sottotop), piletta, troppo/pieno e sifone. Imballo in scatola di cartone.

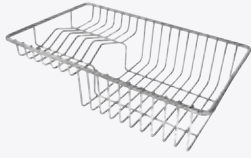
Accessori

| | | | | | |
|---|---|---|--|---|---|
|  | L4 Tagliere cristallo 23x41 cm 8631 300 € 96,00 |  | M6 Tagliere legno noce 18x44,8 cm 8642 000 € 85,00 |  | N3 Tagliere Twin in HDPE 31,7x42,5 8644 101 € 109,00 |
|  | O2 Vaschetta bianca 27,2x41,4 cm 8153 100 € 39,00 |  | P2 * Kit grattugie con anello-supporto e vaschetta vivande 8159 101 € 146,00 |  | P3 Griglia Black 39,2x44,8 cm 8100 600 € 262,00 |
|  | T2 * Cestello portapiatti inox 21,4x37,9 cm 8100 303 € 93,00 |  | Z2 * Vaschetta forata inox 21,5x38 cm 8151 000 € 279,00 |  | PS Piletta Automatica Space Milano 8407 115 € 89,00 |

*utilizzabile solo in abbinamento al tagliere N3

Milanello workstation

LA FUNZIONALITÀ DEL LAVELLO FOSTER MILANO IN UNO SPAZIO PIÙ RIDOTTO



Griglie Black in dotazione
a copertura completa della vasca.



archiproducts

DESIGN AWARDS

—
WINNER 2019

LAVELLI



Piletta SPACE











T/P perimetrale

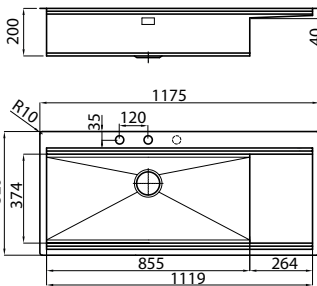

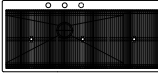
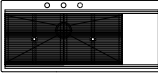
Piletta Salva spazio

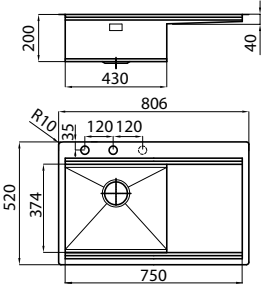
Milanello workstation

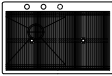
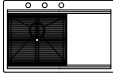
| | Caratteristiche | Versione | Sigla | Prezzo € | Disegno Tecnico | |
|--|--|--|-------------|-------------------|---|--|
| Base 120  | AISI 304 satinato dimensioni: 1175x520 1 vasca: 855x374 incasso FT: vedi sito web incasso FTS: 1158x503 piletta: automatica tipo Space Push (PP) 3½" |  FT | 1043 051 dx | € 2.074,00 |  | |
| | |  FTS | 1043 052 sx | | | |
| In dotazione: 3 griglie Black Milanello (8100 602) |  Configurazione griglie Black a filo vasca |  Configurazione griglie Black su fondo vasca | | | | |
| Accessori opzionali: Z3 T8 M7 L3 L4 N3 N2 P2 T T2 Z Z2 | | | | | | |
| Base 80  | AISI 304 satinato dimensioni: 806x520 1 vasca: 430x374 incasso FT: vedi sito web incasso FTS: 789x503 piletta: automatica tipo Space Push (PP) 3½" |  FT | 1040 051 dx | € 1.720,00 |  | |
| | |  FTS | 1040 052 sx | | | |
| In dotazione: 2 griglie Black Milanello (8100 602) |  Configurazione griglie Black a filo vasca |  Configurazione griglie Black su fondo vasca | | | | |
| Accessori opzionali: Z3 T8 M7 L3 L4 N3 N2 P2 T T2 Z Z2 | | | | | | |



Tutta la praticità di una grande e capiente vasca e di un gocciolatoio essenziale ed elegante, ma soprattutto funzionale nello scolare l'acqua e nelle operazioni di pulizia.



La griglia - in dotazione - alloggia sul fondo per proteggere gli alimenti dagli eventuali residui che possono trovarsi sul fondo vasca.



Sulla doppia corsia trova posto un sistema di accessori modulari e scorrevoli. Sulla corsia interna alloggiano lo scolapiatti e il prezioso scolapasta.



La griglia Black alloggia sul gradino esterno. Sormonta gli accessori scorrevoli e diventa una pratica zona di appoggio e di risciacquo.











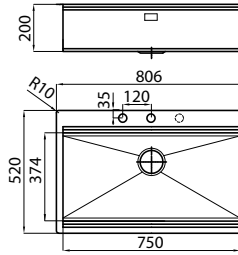

Una ulteriore gamma di taglieri e altri accessori può essere abbinata alle griglie per completare il vostro centro di lavoro.

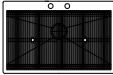
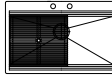

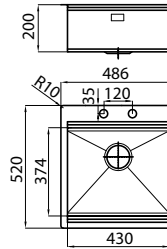
Le griglie Black chiudono totalmente il lavello, trasformandolo in oggetto di design: la sicurezza di una cucina sempre in ordine in ogni momento.

Milanello workstation

| | Caratteristiche | Versione | Sigla | Prezzo € | Disegno Tecnico |
|---|--|---|----------|------------|--|
| Base 80  | AISI 304 satinato dimensioni: 806x520 1 vasca: 750x374 incasso FT: vedi sito web incasso FTS: 789x503 piletta: automatica tipo Space Push (PP) 3½" |  FT | 1034 050 | € 1.437,00 |  |
| | |  FTS | 1034 050 | | |
| In dotazione: 2 griglie Black Milanello (8100 602) | | | | | |
| Accessori opzionali: Z3 T8 M7 L3 L4 N3 N2 P2 T T2 Z Z2 | | | | | |
| | |  Configurazione griglie Black a filo vasca | | |  Configurazione griglie Black su fondo vasca possibilità terzo foro |
| Base 60  | AISI 304 satinato dimensioni: 486x520 1 vasca: 430x374 incasso FT: vedi sito web incasso FTS: 469x503 piletta: automatica tipo Space Push (PP) 3½" |  FT | 1031 050 | € 1.075,00 |  |
| | |  FTS | 1031 050 | | |
| In dotazione: 1 griglia Black Milanello (8100 602) | | | | | |
| Accessori opzionali: Z3 T8 M7 L3 L4 N3 N2 P2 T T2 Z Z2 | | | | | |
| | |  Configurazione griglie Black a filo vasca | | |  Configurazione griglie Black su fondo vasca |

Accessori

accessori opzionali scorrevoli sotto le griglie

Z3
 Vaschetta forata
 inox 21,5x40 cm
 8156 000
 € 274,00

T8
 Griglia portapiatti
 inox 21,4x37,2 cm
 8100 306
 € 80,00

altri accessori opzionali

L3
 Tagliere Twin
 41x41 cm
 8644 004
 € 242,00

L4
 Tagliere cristallo
 23x41 cm
 8631 300
 € 96,00

M7
 Tagliere legno noce
 15,8x42,4 cm
 8642 003
 € 83,00

N2
 Tagliere in HDPE
 27,2x42,5 cm
 8657 001
 € 74,00

N3
 Tagliere Twin
 in HDPE 31,7x42,5
 8644 101
 € 109,00

P2 **
 Kit grattugie con
 anello-supporto e
 vaschetta vivande
 8159 101
 € 146,00

T *
 Griglia portapiatti
 inox 25x35 cm
 8100 154
 € 69,00

T2 **
 Cestello portapiatti
 inox 21,4x37,9 cm
 8100 303
 € 93,00

Z *
 Scolapasta inox
 25x36 cm
 8154 000
 € 187,00

Z2 **
 Vaschetta forata
 inox 21,5x38 cm
 8151 000
 € 279,00

*utilizzabile solo in abbinamento al tagliere L3 **utilizzabile solo in abbinamento al tagliere N3

Milanello PVD workstation











Piletta SPACE



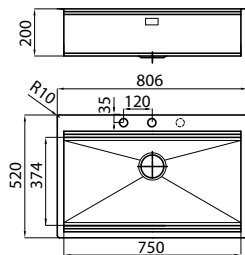

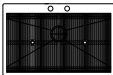
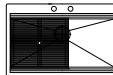

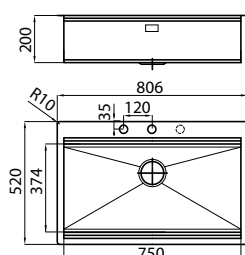
T/P perimetrale

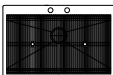
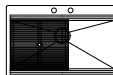

Piletta Salva spazio

| | Caratteristiche | Versione | Sigla | Prezzo € | Disegno Tecnico |
|---|---|---|--|------------------------|---|
| Base 80  | AISI 304 Gun Metal dimensioni: 806x520 1 vasca: 750x374 incasso FT: vedi sito web incasso FTS: 789x503 piletta: automatica tipo Space Push (PO) 3½" |  FT | 1034 056 | € 2.585,00 |  |
| | |  FTS | 1034 056 | | |
| In dotazione: 2 griglie Black Milanello (8100 602) | | | | | |
| Accessori opzionali: Z3 T8 M7 L3 L4 N3 N2 P2 T T2 Z Z2 | | | | | |
| | |  Configurazione griglie Black a filo vasca |  Configurazione griglie Black su fondo vasca | possibilità terzo foro | |
| Base 80  | AISI 304 Copper dimensioni: 806x520 1 vasca: 750x374 incasso FT: vedi sito web incasso FTS: 789x503 piletta: automatica tipo Space Push (PB) 3½" |  FT | 1034 058 | € 2.585,00 |  |
| | |  FTS | 1034 058 | | |
| In dotazione: 2 griglie Black Milanello (8100 602) | | | | | |
| Accessori opzionali: Z3 T8 M7 L3 L4 N3 N2 P2 T T2 Z Z2 | | | | | |
| | |  Configurazione griglie Black a filo vasca |  Configurazione griglie Black su fondo vasca | possibilità terzo foro | |

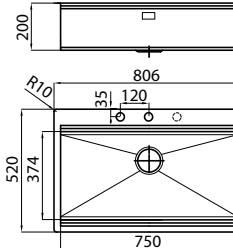
Milanello PVD workstation

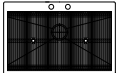
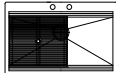
| | Caratteristiche | Versione | Sigla | Prezzo € | Disegno Tecnico |
|--|---|---|---|--|---|
| Base 80  | AISI 304 Gold dimensioni: 806x520 1 vasca: 750x374 incasso FT: vedi sito web incasso FTS: 789x503 piletta: automatica tipo Space Push (PD) 3 1/2" |  FT | 1034 059 | € 2.585,00 |  |
| | |  FTS | 1034 059 | | |
| In dotazione: 2 griglie Black Milanello (8100 602) | | | | | |
| Accessori opzionali: Z3 T8 M7 L3 L4 N3 N2 P2 T T2 Z Z2 | | | | | |
| | |  | Configurazione griglie Black a filo vasca |  | Configurazione griglie Black su fondo vasca |
| | | | | | possibilità terzo foro |

LAVELLI

in dotazione



n. 2 griglie Black Milanello

miscelatori consigliati



Skin Gun Metal
(8424 856 - pag. 166)



Omega Gun Metal
(8497 856 - pag. 181)



Omega Copper
(8497 400 - pag. 182)



Omega Gold
(8497 700 - pag. 182)

Accessori

accessori opzionali scorrevoli sotto le griglie



Z3
Vaschetta forata
inox 21,5x40 cm
8156 000
€ 274,00



T8
Griglia portapiatti
inox 21,4x37,2 cm
8100 306
€ 80,00

altri accessori opzionali



L3
Tagliere Twin
41x41 cm
8644 004
€ 242,00



L4
Tagliere cristallo
23x41 cm
8631 300
€ 96,00



M7
Tagliere legno noce
15,8x42,4 cm
8642 003
€ 83,00



N2
Tagliere in HDPE
27,2x42,5 cm
8657 001
€ 74,00



N3
Tagliere Twin
in HDPE 31,7x42,5
8644 101
€ 109,00



P2 **
Kit grattugie con
anello-supporto e
vaschetta vivande
8159 101
€ 146,00

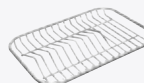

T *
Griglia portapiatti
inox 25x35 cm
8100 154
€ 69,00



T2 **
Cestello portapiatti
inox 21,4x37,9 cm
8100 303
€ 93,00

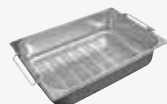

Z *
Scolapasta inox
25x36 cm
8154 000
€ 187,00



Z2 **
Vaschetta forata
inox 21,5x38 cm
8151 000
€ 279,00

*utilizzabile solo in abbinamento al tagliere L3 **utilizzabile solo in abbinamento al tagliere N3

New Wave

SINUOSA ELEGANZA

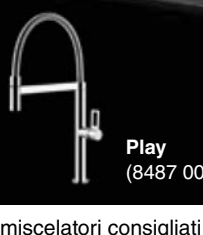

Play
(8487 000 - pag. 163)

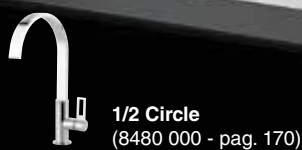

1/2 Circle
(8480 000 - pag. 170)

miscelatori consigliati

| | Caratteristiche | Versione | Sigla | Prezzo € | Disegno Tecnico |
|--|-----------------|----------|-------|----------|-----------------|
|--|-----------------|----------|-------|----------|-----------------|

Base 80



In foto versione sinistra

AISI 304 satinato
dimensioni: **1160x520**
2 vasche: **340x400**
incasso FT: vedi sito web
incasso FTS: 1148x508
piletta: **automatica**
SPACE 3½" PA
Troppo-pieno perimetrale



1420 001 dx
1420 002 sx
1420 001 dx
1420 002 sx

€ 1.613,00

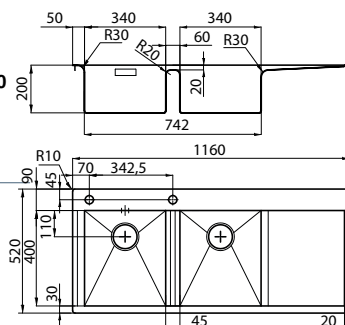

Articolo ad esaurimento

Accessori: **L4 N2 N3 O2 P2 T1 T2 Z2**

Base 80



In foto versione sinistra

AISI 304 satinato
dimensioni: **1160x520**
1 vasca: **710x400**
incasso FT: vedi sito web
incasso FTS: 1148x508
piletta: **automatica**
SPACE 3½" PA
Troppo-pieno perimetrale
Sifone Spazio
ispezionabile



1416 001 dx
1416 002 sx
1416 001 dx
1416 002 sx

€ 1.727,00

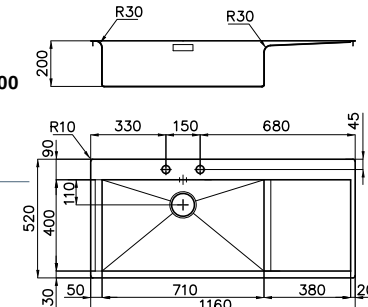

Accessori: **L3 L4 N2 N3 O2 P2 S T T1 T2 Z Z2**

Base 60



AISI 304 satinato
dimensioni: **1160x520**
1 vasca: **500x400**
incasso FT: vedi sito web
incasso FTS: 1148x508
piletta: **automatica**
SPACE 3½" PA
Troppo-pieno perimetrale
Sifone Spazio
ispezionabile



1418 000
1418 000

€ 1.710,00

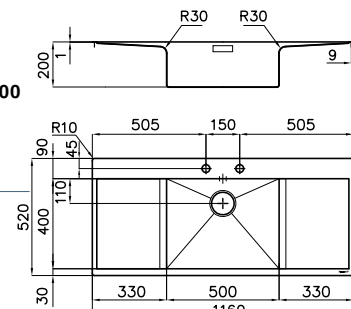







Articolo ad esaurimento

Accessori: **L3 L4 N2 N3 O2 P2 S T T1 T2 Z Z2**

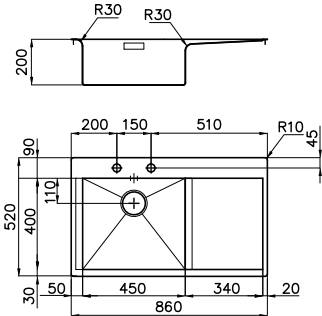
Dotazioni Standard: ganci di fissaggio, guarnizione (no per sottotop), piletta, troppo/pieno e sifone. Imballo in scatola di cartone.

New Wave

| | Caratteristiche | Versione | Sigla | Prezzo € | Disegno Tecnico |
|--|--|---|-------------|-------------------|---|
| Base 60  | AISI 304 satinato dimensioni: 860x520 1 vasca: 450x400 incasso FT: vedi sito web incasso FTS: 848x508 piletta: automatica SPACE 3½" PA Troppo-pieno perimetrale Sifone Spazio ispezionabile |  | 1414 001 dx | € 1.694,00 |  |
| | |  | 1414 002 sx | | |
| | |  | 1414 001 dx | | |
| | |  | 1414 002 sx | | |

Articolo ad esaurimento





In foto versione sinistra

Accessori:

L3 L4 N2 N3 O2 P2 S T T1 T2 Z Z2

Base 80



| | | | |
|--|---|----------|-------------------|
| AISI 304 satinato dimensioni: 810x520 1 vasca: 710x400 incasso FT: vedi sito web incasso FTS: 798x508 piletta: automatica SPACE 3½" PA Troppo-pieno perimetrale Sifone Spazio ispezionabile |  | 1412 000 | € 1.196,00 |
| |  | 1412 000 | |
| |  | 1412 000 | |
| |  | 1412 000 | |

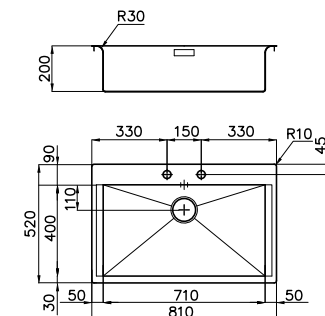





Accessori:

L3 L4 N2 N3 O2 P2 S T T1 T2 Z Z2

Base 60



| | | | |
|--|---|----------|-------------------|
| AISI 304 satinato dimensioni: 600x520 1 vasca: 500x400 incasso FT: vedi sito web incasso FTS: 588x508 piletta: automatica SPACE 3½" PA Troppo-pieno perimetrale Sifone Spazio ispezionabile |  | 1410 000 | € 1.102,00 |
| |  | 1410 000 | |
| |  | 1410 000 | |
| |  | 1410 000 | |

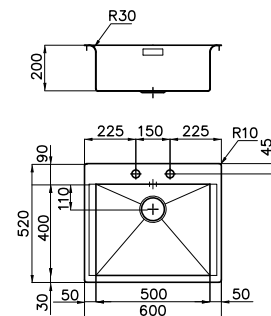

Accessori:

L3 L4 N2 N3 O2 P2 S T T1 T2 Z Z2

Dotazioni Standard: ganci di fissaggio, guarnizione (no per sottotop), piletta, troppo/pieno e sifone. Imballo in scatola di cartone.



Caratteristico design

Il caratteristico design del gocciolatoio New Wave, con il raffinato ampio raggio di raccordo che facilita il deflusso dell'acqua.



Piletta Space

La piletta Space in acciaio, disponibile anche con comando remoto, dona eleganza alla vasca e nasconde ogni residuo, raccolto nel sottostante cestello.



Sifone ispezionabile

Il sifone ispezionabile Space in dotazione ha un ingombro minimo e lascia tutto lo spazio necessario.

Accessori

| | | | |
|---|---|---|---|
|  L3 Tagliere Twin 41x41 cm 8644 004 € 242,00 |  L4 Tagliere cristallo 23x41 cm 8631 300 € 96,00 |  N2 Tagliere in HDPE 27,2x42,5 cm 8657 001 € 74,00 |  N3 Tagliere Twin in HDPE 31,7x42,5 8644 101 € 109,00 |
|  O2 Vaschetta bianca 27,2x41,4 cm 8153 100 € 39,00 |  P2 ** Kit grattugie con anello-supporto e vaschetta vivande 8159 101 € 146,00 |  S Cestello Inox 40x40 8612 000 € 58,00 Cestello bianco 40x40 8612 100 € 37,00 |  T * Griglia portapiatti inox 25x35 cm 8100 154 € 69,00 |
|  T1 Cestello portapiatti inox 25x42,5 cm 8100 201 € 87,00 |  T2 ** Cestello portapiatti inox 21,4x37,9 cm 8100 303 € 93,00 |  Z * Scolapasta inox 25x36 cm 8154 000 € 187,00 |  Z2 ** Vaschetta forata inox 21,5x38 cm 8151 000 € 279,00 |

*utilizzabile solo in abbinamento al tagliere L3 **utilizzabile solo in abbinamento al tagliere N3











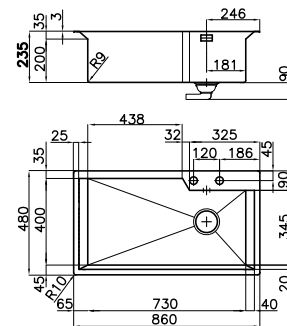

GK

UN DESIGN ESSENZIALE MA RICERCATO

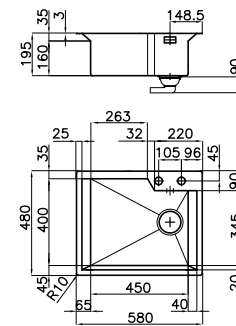

GK
(8488 000 - pag. 162)

Miscelatori consigliati

| | Caratteristiche | Versione | Sigla | Prezzo € | Disegno Tecnico |
|--|---|---|---|----------------------|---|
| Base 90  <p>Articolo ad esaurimento</p> <p>— modello integrabile nei top in acciaio inox</p> <p>In dotazione: PA</p> <p>Accessori opzionali: M4 N4 T2 P2 Z2</p> | AISI 304 satinato profondità vasca: 235 mm dimensioni: 860x480 incasso: 847x467 piletta: autom. SPACE 3½" PA AISI 304 satinato profondità vasca: 235 mm dimensioni: 860x480 incasso FT: vedi sito web incasso FTS: 847x467 piletta: autom. SPACE 3½" PA |  SF | 1402 100 | € 1.265,00 |  |
| | |  FT | 1402 000 | € 1.265,00 | |
| | |  FTS | 1402 000 | € 1.265,00 | |
| | | versione  Vintage |  FT  FTS | 1402 080 1402 080 | |
| Base 60  <p>Articolo ad esaurimento</p> <p>— modello integrabile nei top in acciaio inox</p> <p>In dotazione: PA</p> <p>Accessori opzionali: M4 N4 T2 P2 Z2</p> | AISI 304 satinato profondità vasca: 195 mm dimensioni: 580x480 incasso FT: vedi sito web incasso FTS: 567x467 piletta: autom. SPACE 3½" PA |  FT | 1403 000 | € 1.022,00 |  |
| | |  FTS | 1403 000 | | |

Dotazioni Standard: ganci di fissaggio, guarnizione (no per sottotop), piletta, troppo/pieno e sifone. Imballo in scatola di cartone.

GK

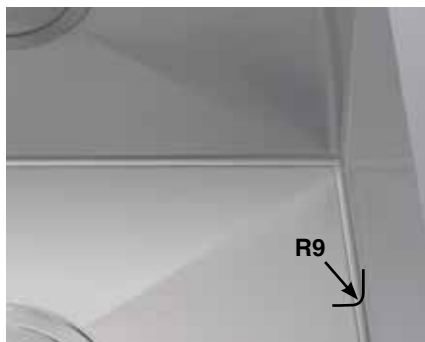

Spigoli raggiati per migliore igiene
Spigoli verticali squadrati si abbinano a quelli morbidi del fondo, pratici ed igienici.



Comando remoto
in dotazione nei modelli filotop e semi-filo, per l'apertura dello scarico senza dover immergere la mano nella vasca.



Elegante piletta SPACE
In dotazione in tutti i modelli, chiude lo scarico e non lascia visibili i residui che sono raccolti nel cestello sottostante.



Piletta e Sifone salvaspazio
I Lavelli Gk sono dotati di piletta e sifone salvaspazio con un ingombro ridotto che permette il migliore utilizzo dell'area sotto-lavello.



Troppo pieno perimetrale
La cura dei particolari e il design minimale si riscontrano anche nell'originale troppo-pieno con scarico perimetrale che impreziosisce la vasca.



Pratico Invaso inclinato
L'invaso inclinato accomuna lavello e piano cottura creando un abbinamento di grande classe, funzionale nell'utilizzo e nella pulizia delle superfici.

Un originale set di accessori

Un set completo di accessori che alloggiato perfettamente nella capiente vasca rendono il GK una postazione di lavoro completa e funzionale per preparazione e lavaggio.



accessori



M4
Tagliere scorrevole Iroko
8656 001

€ 110,00



N4
Tagliere Twin in HDPE
8644 100

€ 121,00



T2
Cestello portapiatti inox
25x42,5 cm
8100 303
€ 93,00



P2
Kit grattugie con anello-supporto
e vaschetta
8159 101
€ 146,00



Z2
Vaschetta forata inox
8151 000

€ 279,00

S4001 - lavelli filotop

NEW

CAPIENTI VASCHE IMPREZIOSITE DALL'AMPIO BANCO RUBINETTERIA







Play
(8487 000 - pag. 163)





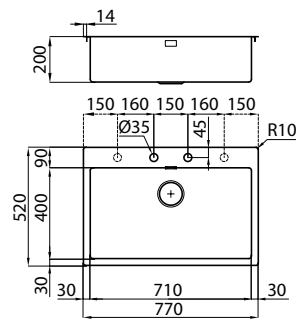





Tre Alto
(8468 000 - pag. 172)

miscelatori consigliati

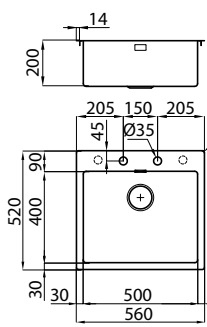
| | Caratteristiche | Versione | Sigla | Prezzo € | Disegno Tecnico |
|--|--|---|----------|-----------------|---|
| Base 80  | AISI 304 satinato dimensioni: 770x520 1 vasca: 710x400 incasso FT: vedi sito web incasso FTS: 758x508 piletta automatica SPACE 3½" PA |  | 3366 050 | € 986,00 |  |
| | |  | 3366 050 | | |
| Accessori: L3 L4 N2 N3 O2 P2 P4 S T T1 T2 Z Z2 | | | | | |



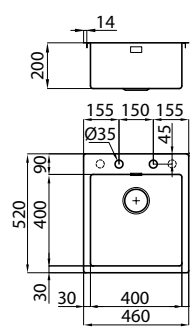







possibilità 3° e 4° foro

S4001 - lavelli filotop

| | Caratteristiche | Versione | Sigla | Prezzo € | Disegno Tecnico |
|--|--|---|----------|-----------------|---|
| Base 60  | AISI 304 satinato dimensioni: 560x520 1 vasca: 500x400 incasso FT: vedi sito web incasso FTS: 548x508 piletta automatica SPACE 3½" PA |  | 3365 050 | € 882,00 |  |
| | |  | 3365 050 | | |
| Accessori: L3 L4 N2 N3 O2 P2 P4 S T T1 T2 Z Z2 | | | | | |
| Base 45  | AISI 304 satinato dimensioni: 460x520 1 vasca: 400x400 incasso FT: vedi sito web incasso FTS: 448x508 piletta automatica SPACE 3½" PA |  | 3363 050 | € 851,00 |  |
| | |  | 3363 050 | | |
| Accessori: L3 L4 N2 N3 O2 P2 P4 S T T1 T2 Z Z2 | | | | | |

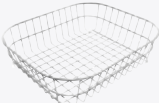
LAVELLI

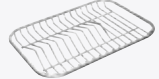
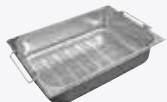
accessori

| | | | | | |
|--|---|---|--|---|---|
|  <p>L3 Tagliere Twin 41x41 cm 8644 004 € 242,00</p> |  <p>L4 Tagliere cristallo 23x41 cm 8631 300 € 96,00</p> |  <p>N2 Tagliere in HDPE 27,2x42,5 cm 8657 001 € 74,00</p> |  <p>N3 Tagliere Twin in HDPE 31,7x42,5 8644 101 € 109,00</p> |  <p>O2 Vaschetta bianca 27,2x41,4 cm 8153 100 € 39,00</p> |  <p>P2 ** Kit grattugie con anello-supporto e vaschetta vivande 8159 101 € 146,00</p> |
|  <p>P4 Kit tagliere con vaschetta scolapasta in acciaio inox 8644 044 € 278,00</p> |  <p>R Cestello Inox 34x40 cm 8611 000 € 50,00</p> |  <p>S Cestello Inox 40x40 - 8612 000 € 58,00 Cestello bianco 40x40 - 8612 100 € 37,00</p> |  <p>T * Griglia portapiatti inox 25x35 cm 8100 154 € 69,00</p> |  <p>Z * Scolapasta inox 25x36 cm 8154 000 € 187,00</p> |  <p>Z2 ** Vaschetta forata inox 21,5x38 cm 8151 000 € 279,00</p> |

*utilizzabile solo in abbinamento al tagliere L3 **utilizzabile solo in abbinamento al tagliere N3

S4001 - vasche filotop NEW

QUALITÀ ESSENZIALE



Piletta SPACE



T/P perimetrale



Piletta Salva spazio













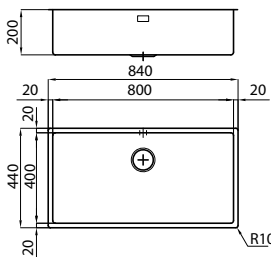

Tre Alto
(8468 000 - pag. 172)

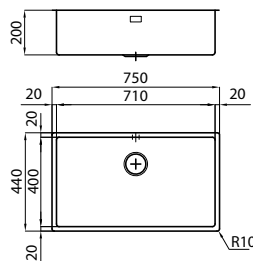

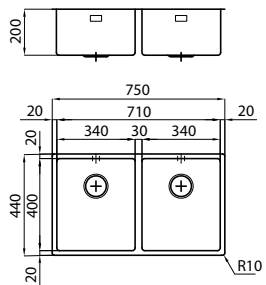

1/2 Circle
(8480 000 - pag. 170)



miscelatori consigliati

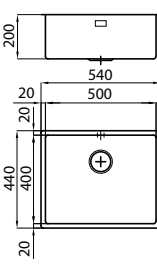

| | Caratteristiche | Versione | Sigla | Prezzo € | Disegno Tecnico |
|--|--|---|----------|-----------------|---|
| Base 90  | AISI 304 satinato dimensioni: 840x440 1 vasca: 800x400 incasso FT: v. sito web* incasso FTS: 820x430* piletta: SPACE 3½" |  FT | 3358 050 | € 722,00 |  |
| | |  FTS | 3358 050 | | |
| * Il foro incasso necessita di intaglio per l'alloggio del troppo-pieno (solo per top > 30) | | | | | |
| Accessori: L3 L4 N2 N3 O2 P2 P4 S T T1 T2 Z Z2 Piletta automatica: PA PE PM PL PP PS (v. pag. 148-149) | | | | | |
| Base 80  | AISI 304 satinato dimensioni: 750x440 1 vasca: 710x400 incasso FT: v. sito web* incasso FTS: 730x430* piletta: SPACE 3½" |  FT | 3357 050 | € 673,00 |  |
| | |  FTS | 3357 050 | | |
| * Il foro incasso necessita di intaglio per l'alloggio del troppo-pieno (solo per top > 30) | | | | | |
| Accessori: L3 L4 N2 N3 O2 P2 P4 S T T1 T2 Z Z2 Piletta automatica: PA PE PM PL PP PS (v. pag. 148-149) | | | | | |
| Base 80  | AISI 304 satinato dimensioni: 750x440 2 vasche: 340x400 incasso FT: v. sito web* incasso FTS: 730x430* piletta: SPACE 3½" |  FT | 3352 050 | € 919,00 |  |
| | |  FTS | 3352 050 | | |
| * Il foro incasso necessita di intaglio per l'alloggio del troppo-pieno (solo per top > 30) | | | | | |
| Accessori: L4 N2 N3 O2 P2 P4 R T1 T2 Z2 Piletta automatica: PA PE PM PL PP PS (v. pag. 148-149) | | | | | |

Dotazioni Standard: ganci di fissaggio, guarnizione (no per sottotop), piletta, troppo/pieno e sifone. Imballo in scatola di cartone.

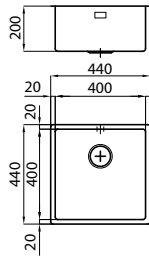
S4001 - vasche filotop



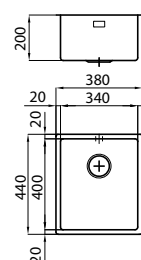











| | Caratteristiche | Versione | Sigla | Prezzo € | Disegno Tecnico |
|---|---|---|----------|-----------------|---|
| Base 60 | AISI 304 satinato dimensioni: 540x440 1 vasca: 500x400 incasso FT: v. sito web* incasso FTS: 520x430* piletta: SPACE 3½" |  FT | 3355 050 | € 576,00 |  |
| | |  FTS | 3355 050 | | |
| * Il foro incasso necessita di intaglio per l'alloggio del troppo-pieno (solo per top > 30) | | | | | |
| Accessori: L3 L4 N2 N3 O2 P2 P4 S T T1 | | | | | |
| T2 Z Z2 | | | | | |
| Piletta automatica: PA PE PM PL PP PS (v. pag. 148-149) | | | | | |

| | | | | | |
|---|---|---|----------|-----------------|---|
| Base 45 | AISI 304 satinato dimensioni: 400x400 1 vasca: 400x400 incasso FT: v. sito web* incasso FTS: 420x430* piletta: SPACE 3½" |  FT | 3356 050 | € 449,00 |  |
| | |  FTS | 3356 050 | | |
| * Il foro incasso necessita di intaglio per l'alloggio del troppo-pieno (solo per top > 30) | | | | | |
| Accessori: L3 L4 N2 N3 O2 P2 P4 S T T1 | | | | | |
| T2 Z Z2 | | | | | |
| Piletta automatica: PA PE PM PL PP PS (v. pag. 148-149) | | | | | |

| | | | | | |
|---|---|---|----------|-----------------|---|
| Base 40 | AISI 304 satinato dimensioni: 380x440 1 vasca: 340x400 incasso FT: v. sito web* incasso FTS: 360x430* piletta: SPACE 3½" |  FT | 3353 050 | € 438,00 |  |
| | |  FTS | 3353 050 | | |
| * Il foro incasso necessita di intaglio per l'alloggio del troppo-pieno (solo per top > 30) | | | | | |
| Accessori: L4 N2 N3 O2 P2 P4 R T1 T2 Z2 | | | | | |
| Piletta automatica: PA PE PM PL PP PS (v. pag. 148-149) | | | | | |

Dotazioni Standard: ganci di fissaggio, guarnizione (no per sottotop), piletta, troppo/pieno e sifone. Imballo in scatola di cartone.

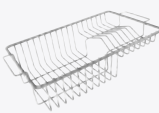
accessori

| | | | | | | | | | | | |
|---|--|---|---|---|--|---|---|---|---|---|--|
|  | L3 Tagliere Twin 41x41 cm 8644 004 € 242,00 |  | L4 Tagliere cristallo 23x41 cm 8631 300 € 96,00 |  | N2 Tagliere in HDPE 27,2x42,5 cm 8657 001 € 74,00 |  | N3 Tagliere Twin in HDPE 31,7x42,5 8644 101 € 109,00 |  | O2 Vaschetta bianca 27,2x41,4 cm 8153 100 € 39,00 |  | P2 ** Kit grattugie con anello-supporto e vaschetta vivande 8159 101 € 146,00 |
|  | P4 Kit tagliere con vaschetta scolapasta in acciaio inox 8644 044 € 278,00 |  | R Cestello Inox 34x40 cm 8611 000 € 50,00 |  | S Cestello Inox 40x40 - 8612 000 € 58,00 Cestello bianco 40x40 - 8612 100 € 37,00 |  | T * Griglia portapiatti inox 25x35 cm 8100 154 € 69,00 |  | Z * Scolapasta inox 25x36 cm 8154 000 € 187,00 |  | Z2 ** Vaschetta forata inox 21,5x38 cm 8151 000 € 279,00 |
|  | T1 Cestello portapiatti inox 25x42,5 cm 8100 201 € 87,00 |  | T2 ** Cestello portapiatti inox 21,4x37,9 cm 8100 303 € 93,00 | | | | | | | | |

*utilizzabile solo in abbinamento al tagliere L3 **utilizzabile solo in abbinamento al tagliere N3

S4000

UN DESIGN INCONFONDIBILE



T/P perimetrale

miscelatori consigliati



Play
(8487 000 - pag. 163)







Camillo
(8467 000 - pag. 169)

| | Caratteristiche | Versione | Sigla | Prezzo € | Disegno Tecnico |
|--|--|----------|-------------|-----------------|--|
| Base 80 | AISI 304 spazzolato dimensioni: 1173x513 2 vasche: 340x400 incasso FT: vedi sito web incasso FTS: 1160x500 piletta: 3½" | FT | 4315 051 dx | € 973,00 | Le quote perimetrali si riferiscono alla versione filotop |
| | | FT | 4315 052 sx | | |
| | | FTS | 4315 051 dx | | |
| | | FTS | 4315 052 sx | | |
| <p>In foto versione sinistra</p> | | | | | |
| Accessori: L4 N2 N3 O2 P2 P4 R T2 Z2 Solo per bordo Q4: L5 M | | | | | |
| possibilità secondo foro | | | | | |

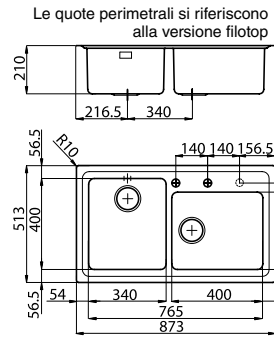
Dotazioni Standard: ganci di fissaggio, guarnizione (no per sottotop), piletta, tropp/pieno e sifone. Imballo in scatola di cartone.

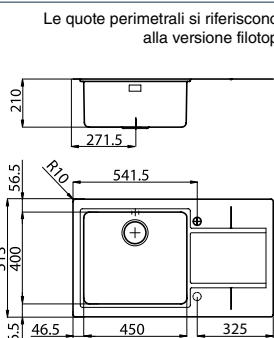
S4000

| | Caratteristiche | Versione | Sigla | Prezzo € | Disegno Tecnico |
|--|--|---|-------------|-----------------|--|
| Base 90 | AISI 304 spazzolato dimensioni: 873x513 2v: 340x400+400x340 incasso FT: vedi sito web incasso FTS: 860x500 piletta automatica 3½" PM |  FT | 4385 050 | € 891,00 | <p>Le quote perimetrali si riferiscono alla versione filotop</p>  |
| | |  FTS | 4385 050 | | |
| Accessori: L4 N2 N3 O2 P2 P4 R T2 Z2 | | | | | |
| Base 60 | AISI 304 spazzolato dimensioni: 873x513 1 vasca: 450x400 incasso FT: vedi sito web incasso FTS: 860x500 piletta: 3½" |  FT | 4386 051 dx | € 718,00 | <p>Le quote perimetrali si riferiscono alla versione filotop</p> <p>Possibilità terzo foro</p>  |
| | |  FTS | 4386 051 dx | | |
| Accessori: L3 L4 N2 N3 O2 P2 P4 S T T2 Z Z2 | | | | | |

In foto versione sinistra

Dotazioni Standard: ganci di fissaggio, guarnizione (no per sottotop), piletta, tropp/pieno e sifone. Imballo in scatola di cartone.

accessori

| | | | | | | | |
|---|---|---|--|---|--|---|--|
|  | L3 Tagliere Twin 41x41 cm 8644 004 € 242,00 |  | L4 Tagliere cristallo 23x41 cm 8631 300 € 96,00 |  | L5 Tagliere cristallo 29x54 cm 8633 300 € 110,00 |  | M Tagliere scorrevole 30x54 cm 8643 000 € 114,00 |
|  | N2 Tagliere in HDPE 27,2x42,5 cm 8657 001 € 74,00 |  | N3 Tagliere Twin in HDPE 31,7x42,5 cm 8644 101 € 109,00 |  | O2 Vaschetta bianca 27,2x41,4 cm 8153 100 € 39,00 |  | P2 ** Kit grattugie con anello-supporto e vaschetta raccogli vivande - 8159 101 € 146,00 |
|  | P4 Kit tagliere con vaschetta scolapasta in acciaio inox 8644 044 € 278,00 |  | R Cestello Inox 34x40 cm 8611 000 € 50,00 |  | S Cestello Inox 40x40 8612 000 € 58,00 Cestello bianco 40x40 8612 100 € 37,00 |  | T * Griglia portapiatti 25x35 cm 8100 154 € 69,00 |
|  | T1 Cestello portapiatti 25x42,5 cm 8100 201 € 87,00 |  | T2 ** Cestello portapiatti inox 21,4x37,9 cm 8100 303 € 93,00 |  | Z * Scolapasta inox 25x36 cm 8154 000 € 187,00 |  | Z2 ** Vaschetta forata inox 21,5x38 cm 8151 000 € 279,00 |

*utilizzabile solo in abbinamento al tagliere L3 **utilizzabile solo in abbinamento al tagliere N3

Quadra

LA PERFEZIONE FORMALE

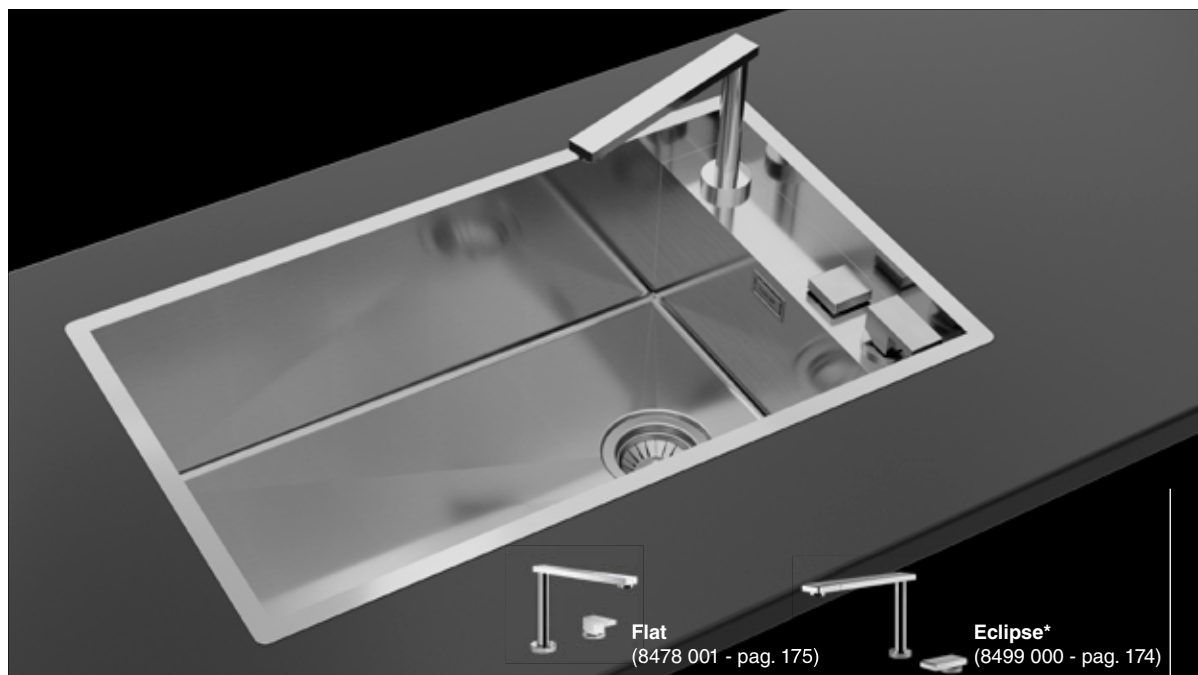

T/P perimetrale

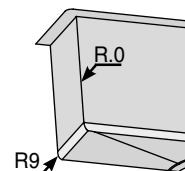

Fondo raggiato R9

*Miscelatore Eclipse compatibile cambiando la piletta automatica con uno tra i modelli PP e PL.

miscelatori consigliati

| | Caratteristiche | Versione | Sigla | Prezzo € | Disegno Tecnico |
|--|-----------------|----------|-------|----------|-----------------|
|--|-----------------|----------|-------|----------|-----------------|

Base 80

NEW



AISI 304 satinato
dimensioni: **750x440**
1 vasca: **630x400**
incasso: vedi sito web
incasso FTS: 730x420
piletta **autom.** 3½" PM

| | |
|--|----------|
| | 1237 050 |
| | 1237 050 |

€ 1.025,00

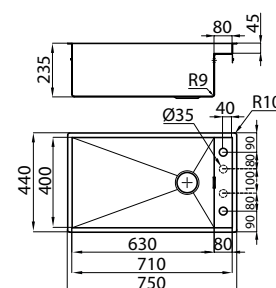

Possibilità terzo e quarto foro

Accessori: **L3 L4 N2 N3 O2 P2 P4 S T T1 T2 Z Z2** (vedi pag. 79)

Base 60

NEW



AISI 304 satinato
dimensioni: **540x440**
1 vasca: **420x400**
incasso: vedi sito web
incasso FTS: 520x420
piletta **autom.** 3½" PM

| | |
|--|----------|
| | 1235 050 |
| | 1235 050 |

€ 903,00



il lavello può essere installato con banco rubinetteria frontale o laterale.

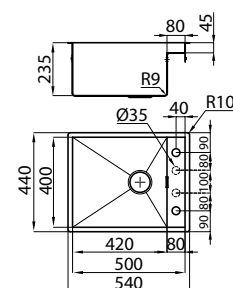

Possibilità terzo e quarto foro

Accessori: **L3 L4 N2 N3 O2 P2 P4 S T T1 T2 Z Z2** (vedi pag. 79)

Base 45

NEW



AISI 304 satinato
dimensioni: **440x440**
1 vasca: **320x400**
incasso: vedi sito web
incasso FTS: 420x420
piletta **autom.** 3½" PM

| | |
|--|----------|
| | 1236 050 |
| | 1236 050 |

€ 858,00



il lavello può essere installato con banco rubinetteria frontale o laterale.

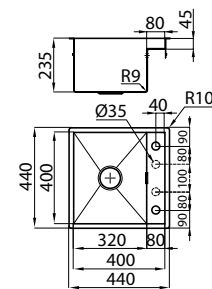











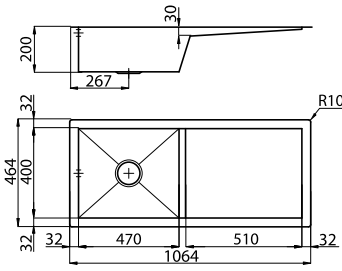



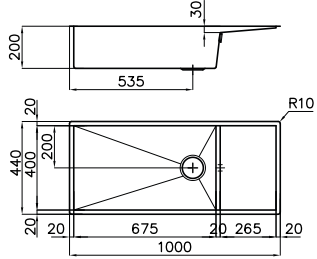



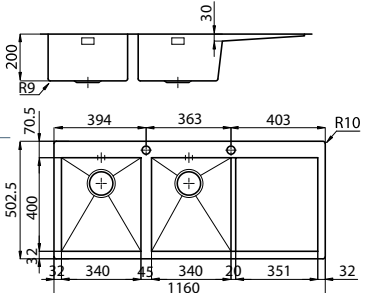

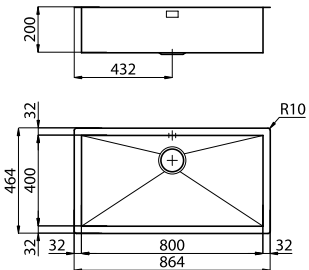

Possibilità terzo e quarto foro

Accessori: **L3 L4 N2 N3 O2 P2 P4 S T T1 T2 Z Z2** (vedi pag. 79)

Dotazioni Standard: ganci di fissaggio, guarnizione (no per sottotop), piletta, troppo/pieno e sifone. Imballo in scatola di cartone.

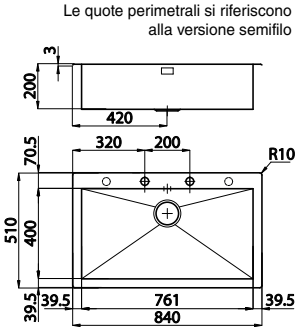











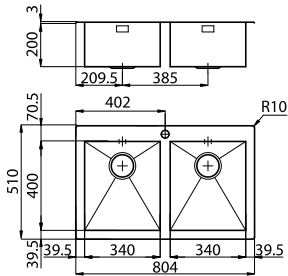



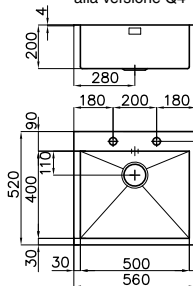

Quadra

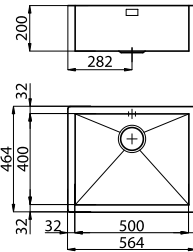
| | Caratteristiche | Versione | Sigla | Prezzo € | Disegno Tecnico |
|--|---|---|-------------|-------------------|---|
| Base (60)°/120 (rif. pag. 55)  | AISI 304 satinato dimensioni: 1064x464 1 vasca: 470x400 incasso FT: vedi sito web incasso FTS: 1047x447 piletta: 3½" |  FT | 1210 050 | € 1.409,00 |  |
| | |  FTS | 1210 050 | | |
| Articolo ad esaurimento | | | | | |
| Accessori: L3 L4 N2 N3 O2 P2 P4 S T T1 T2 Z Z2 (vedi pag. 79) Piletta automatica: PA PE PM PL PP PS (v. pag. 148) | | | | | |
| Base (80)°/120 (rif. pag. 55)  | AISI 304 satinato dimensioni: 1000x440 1 vasca: 675x400 incasso FT: vedi sito web incasso FTS: 987x427 piletta: 3½" |  FT | 1220 050 | € 1.251,00 |  |
| | |  FTS | 1220 050 | | |
| Accessori: L3 L4 N2 N3 O2 P2 P4 S T T1 T2 Z Z2 (vedi pag. 79) Piletta automatica: PA PE PM PL PP PS (v. pag. 148) | | | | | |
| Base (80)°/120 (rif. pag. 55)  | AISI 304 satinato dimensioni: 1160x502 2 vasche: 340x400 incasso FT: vedi sito web incasso FTS: 1143x485 piletta: automatica 3½" PM |  FT | 1228 051 dx | € 1.482,00 |  |
| | |  FTS | 1228 051 dx | | |
| |  FT | 1228 052 sx | | | |
| |  FTS | 1228 052 sx | | | |
| Articolo ad esaurimento | | | | | |
| In foto versione sinistra Accessori: (vedi pag. 79) L4 N2 N3 O2 P2 P4 R T1 T2 Z2 | | | | | |
| Base 90  | AISI 304 satinato dimensioni: 864x464 1 vasca: 800x400 incasso FT: vedi sito web incasso FTS: 847x447 piletta: 3½" |  FT | 1218 050 | € 817,00 |  |
| | |  FTS | 1218 050 | | |
| Accessori: L3 L4 N2 N3 O2 P2 P4 S T T1 T2 Z Z2 (vedi pag. 79) Piletta automatica: PA PE PM PL PP PS (v. pag. 148) | | | | | |
| Base 90  | AISI 304 satinato dimensioni: 840x510 1 vasca: 761x400 incasso: 820x495 piletta: automatica 3½" PM |  SF | 1219 050 | € 973,00 | Le quote perimetrali si riferiscono alla versione semifilo  |
| | |  FT | 1229 050 | | |
| |  FTS | 1229 050 | | | |
| Accessori: L3 L4 N2 N3 O2 P2 P4 S T T1 T2 Z Z2 (vedi pag. 79) | | | | | |

Dotazioni Standard: ganci di fissaggio, guarnizione (no per sottotop), piletta, troppopieno e sifone. Imballo in scatola di cartone.

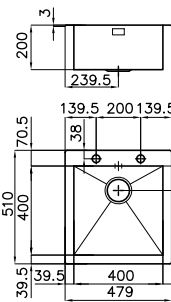
LAVELLI

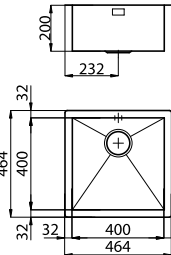
Quadra

| | Caratteristiche | Versione | Sigla | Prezzo € | Disegno Tecnico |
|--|--|---|----------|------------|---|
| Base 80  | AISI 304 satinato dimensioni: 804x510 2 vasche: 340x400 incasso: 784x495 piletta: 3½" |  | 1209 050 | € 1.380,00 | Le quote perimetrali si riferiscono alla versione semifino  |
| | | Articolo ad esaurimento | | | |
| | AISI 304 satinato dimensioni: 789x503 2 vasche: 340x400 incasso FT: vedi sito web incasso FTS: 772x486 piletta: 3½" |  | 1208 050 | € 1.380,00 | |
| | |  | 1208 050 | | |
| Accessori: (vedi pag. 79) L4 N2 N3 O2 P2 P4 R T1 T2 Z2 | | | | | |
| Base 60  | AISI 304 satinato dimensioni: 560x520 1 vasca: 500x400 incasso: 540x500 piletta: automatica 3½" PM |  | 1243 050 | € 894,00 | Le quote perimetrali si riferiscono alla versione Q4  |
| | |  | 1216 050 | € 860,00 | |
| Accessori: L3 L4 N2 N3 O2 P2 P4 S T T1 T2 Z Z2 (vedi pag. 79) | | | | | |
| Base 60  | AISI 304 satinato dimensioni: 564x464 1 vasca: 500x400 incasso FT: vedi sito web incasso FTS: 547x447 piletta: 3½" |  | 1215 050 | € 742,00 |  |
| | |  | 1215 050 | | |
| Accessori: L3 L4 N2 N3 O2 P2 P4 S T T1 T2 Z Z2 (vedi pag. 79) Piletta automatica: PA PE PM PL PP PS (v. pag. 148) | | | | | |
| Base 45  | AISI 304 satinato dimensioni: 479x510 1 vasca: 400x400 incasso: 459x495 piletta: automatica 3½" PM |  | 1205 050 | € 668,00 |  |
| | | | | | |
| Accessori: L3 L4 N2 N3 O2 P2 P4 S T T1 T2 Z Z2 (vedi pag. 79) | | | | | |
| Base 45  | AISI 304 satinato dimensioni: 464x464 1 vasca: 400x400 incasso FT: vedi sito web incasso FTS: 447x447 piletta: 3½" |  | 1214 050 | € 701,00 |  |
| | |  | 1214 050 | | |
| Accessori: L3 L4 N2 N3 O2 P2 P4 S T T1 T2 Z Z2 (vedi pag. 79) Piletta automatica: PA PE PM PL PP PS (v. pag. 148) | | | | | |

Dotazioni Standard: ganci di fissaggio, guarnizione (no per sottotop), piletta, troppo/pieno e sifone. Imballo in scatola di cartone.

Quadra

| | Caratteristiche | Versione | Sigla | Prezzo € | Disegno Tecnico |
|--|-----------------|----------|-------|----------|-----------------|
|--|-----------------|----------|-------|----------|-----------------|

Base 40



AISI 304 satinato
dimensioni: **400x520**
1 vasca: **340x400**
incasso: 380x500
piletta:
automatica 3½" PM



1241 050

€ 888,00

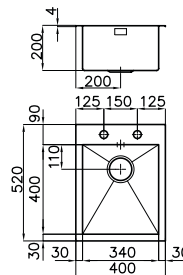

Accessori: **L4 N2 N3 O2 P2 P4 T1 T2 Z2**

Base 90



AISI 304 satinato
dimensioni: **864x464**
1 vasca: **800x400**
incasso FT: vedi sito web
incasso FTS: 847x447
piletta: 7"



1218 097

€ 860,00



1218 097

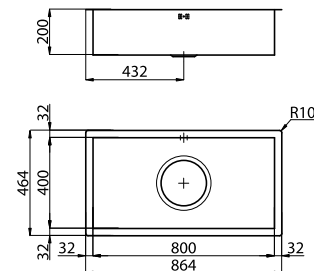

Accessori: **L3 L4 N2 O2 S T T1 Z**

Disponibile anche nella versione sottotop a pag. 123

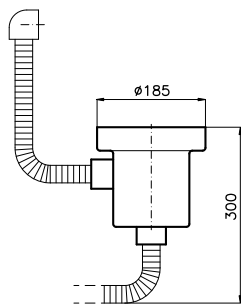



Piletta Extralarge

Lo scarico 7" ha dimensioni decisamente superiori allo standard. La piletta comprende un capiente e profondo cestello per la raccolta dei residui alimentari (cod. 8403 309).



Dotazioni Standard: ganci di fissaggio, guarnizione (no per sottotop), piletta 7"/sifone, troppo/pieno. Imballo in scatola di cartone.

accessori

| | | | |
|--|---|---|--|
|  <p>L3 Tagliere Twin 41x41 cm 8644 004 € 242,00</p> |  <p>L4 Tagliere cristallo 23x41 cm 8631 300 € 96,00</p> |  <p>M Tagliere scorrevole 30x54 cm 8643 000 € 114,00</p> | |
|  <p>N2 Tagliere in HDPE 27,2x42,5 cm 8657 001 € 74,00</p> |  <p>N3 Tagliere Twin in HDPE 31,7x42,5 cm 8644 101 € 109,00</p> |  <p>O2 Vaschetta bianca 27,2x41,4 cm 8153 100 € 39,00</p> |  <p>P2 ** Kit grattugie con anello-supporto e vaschetta raccogli vivande - 8159 101 € 146,00</p> |
|  <p>P4 Kit tagliere con vaschetta scolapasta in acciaio inox 8644 044 € 278,00</p> |  <p>R Cestello Inox 34x40 cm 8611 000 € 50,00</p> |  <p>S Cestello Inox 40x40 8612 000 € 58,00 Cestello bianco 40x40 8612 100 € 37,00</p> |  <p>T * Griglia portapiatti 25x35 cm 8100 154 € 69,00</p> |
|  <p>T1 Cestello portapiatti 25x42,5 cm 8100 201 € 87,00</p> |  <p>T2 ** Cestello portapiatti inox 21,4x37,9 cm 8100 303 € 93,00</p> |  <p>Z * Scolapasta inox 25x36 cm 8154 000 € 187,00</p> |  <p>Z2 ** Vaschetta forata inox 21,5x38 cm 8151 000 € 279,00</p> |

*utilizzabile solo in abbinamento al tagliere L3 **utilizzabile solo in abbinamento al tagliere N3

LAVELLI

Fortyfour **NEW**

ELEGANZA E PRATICITÀ PER I PICCOLI SPAZI





Tre Alto
(8468 000 - pag. 172)



Master
(8493 000 - pag. 172)

miscelatori consigliati

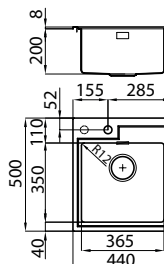
| | Caratteristiche | Versione | Sigla | Prezzo € | Disegno Tecnico |
|---|--|--|----------|----------|--|
| Base 45  | AISI 304 satinato dimensioni: 440x500 1 vasca: 365x350 incasso: 420x480 piletta: 3½" |  | 4151 050 | € 441,00 |  |
| Accessori: B6 T6 Piletta automatica: PA PE PM PL PP PS (v. pag. 148-149) | | | | | Possibilità secondo foro |

Dotazioni Standard: ganci di fissaggio, guarnizione (no per sottotop), piletta, troppo/pieno e sifone. Imballo in scatola di cartone.

Abbinamento perfetto

Fortyfour è un lavello pensato per i piccoli spazi che richiedono estetica e funzionalità. Tutta la libertà di abbinamento: Fortyfour è perfettamente coordinato con il piano cottura Veronika 3 fuochi e con il piano induzione S1000 3 zone.



Veronika 3F
cod. 7063 052
pag. 243



S1000 3 zone
cod. 7373 300
pag. 207

accessori



B6
Tagliere
26x36,6 cm
8643 117
€ 71,00







T6
Griglia portapiatti
inox 23x37,5
8100 305
€ 83,00

CQ

DESIGN A TUTTO TONDO

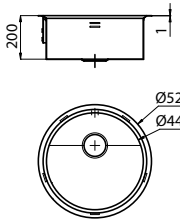

miscelatori consigliati

| | Caratteristiche | Versione | Sigla | Prezzo € | Disegno Tecnico |
|--|---|---|----------|------------|--|
| Base 60  | AISI 304 satinato dimensioni: Ø 520 1 vasca: Ø 445 incasso FT: vedi sito web incasso FTS: Ø 500 piletta: SPACE 3½" |  FT | 1222 000 | € 1.097,00 |  |
| | |  FTS | 1222 000 | | |

Accessori: **T7** **P6**

Dotazioni Standard: ganci di fissaggio, guarnizione (no per sottotop), piletta, troppo/pieno e sifone. Imballo in scatola di cartone.

Accessori inconsueti

Il lavello CQ è corredato da un originale set di accessori. Il compatto kit con tagliere, griglia e colapasta rende facile ogni operazione.

**accessori**

T7
Griglia portapiatti
8100 051
€ 93,00



P6
Kit Cestello+
scolapasta+Tagliere
8100 151
€ 190,00

Master

PURA ELEGANZA FUNZIONALE



T/P perimetrale













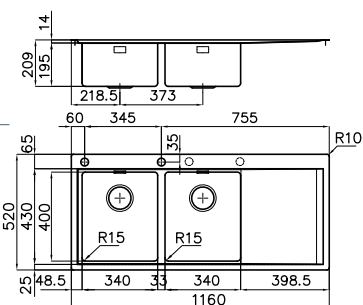

Master
(8493 000 - pag. 172)

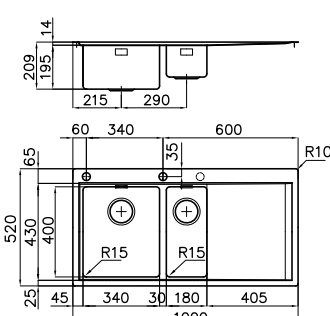

Play
(8487 000 - pag. 163)

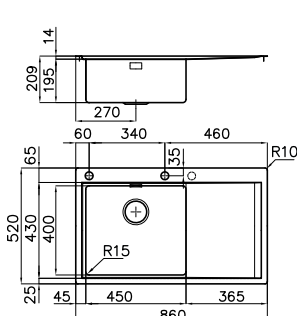
miscelatori consigliati

| | Caratteristiche | Versione | Sigla | Prezzo € | Disegno Tecnico |
|--|--|---|-------------|-----------------|---|
| Base 80  <i>In foto versione sinistra</i> Accessori: (vedi pag. 79) L4 N2 N3 O2 P2 P4 R T1 T2 Z2 | AISI 304 spazzolato dimensioni: 1160x520 2v: 340x400 incasso FT: vedi sito web incasso FTS: 1147x507 piletta: autom. 3½" PM |  | 1252 051 dx | € 945,00 |  Possibilità terzo e quarto foro |
| | |  | 1252 052 sx | | |
| Base 60  <i>In foto versione sinistra</i> Accessori: L4 N2 N3 O2 P2 P4 R T1 T2 Z2 (vedi pag. 79) | AISI 304 spazzolato dimensioni: 1000x520 2v: 340x400 + 180x400 incasso FT: vedi sito web incasso FTS: 987x507 piletta: autom. 3½" PM |  | 1251 051 dx | € 838,00 |  Possibilità terzo foro |
| | |  | 1251 052 sx | | |
| Base 60  <i>In foto versione sinistra</i> Accessori: L3 L4 N2 N3 O2 P2 P4 S T T1 T2 Z Z2 (vedi pag. 79) | AISI 304 spazzolato dimensioni: 860x520 1v: 450x400 incasso FT: vedi sito web incasso FTS: 847x507 piletta: autom. 3½" PM |  | 1250 051 dx | € 720,00 |  Possibilità terzo foro |
| | |  | 1250 052 sx | | |

Dotazioni Standard: ganci di fissaggio, guarnizione (no per sottotop), piletta, troppo/pieno e sifone. Imballo in scatola di cartone.

FL

IL MONOVASCA MULTIFUNZIONE



Piletta SPACE



T/P perimetrale



Piletta Salva spazio









Master
(8493 000 - pag. 172)

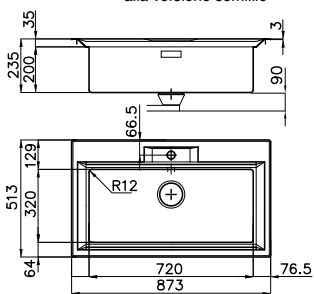

Play
(8487 000 - pag. 163)

miscelatori consigliati

| | Caratteristiche | Versione | Sigla | Prezzo € | Disegno Tecnico |
|--|---|---|----------|----------|--|
| Base 80  | AISI 304 spazzolato dimensioni: 860x500 vasca: 720x320 incasso: 840x480 piletta: 3½" |  STD | 2975 060 | € 596,00 | Le quote perimetrali si riferiscono alla versione semifilo  |
| | AISI 304 spazzolato dimensioni: 873x513 vasca: 720x320 incasso: 840x480 piletta: 3½" |  SF | 2976 060 | € 851,00 | |
| | AISI 304 spazzolato dimensioni: 873x513 vasca: 720x320 incasso FT: vedi sito web incasso FTS: 860x500 piletta: 3½" |  FT | 2977 060 | € 851,00 | |
| | |  FTS | 2977 060 | | |

Accessori: **M5** **T5**

Dotazioni Standard: ganci di fissaggio, guarnizione (no per sottotop), piletta, tropp/pieno e sifone. Imballo in scatola di cartone.

accessori

Accessori sovrapponibili



M5
Tagliere scorrevole in legno iroko
33,2x38,4 cm
8659 113
€ 80,00



T5
Cestello portapiatti inox
21,4x33,1 cm
8100 304
€ 84,00



Due corsie sulle quali scorrono in modo indipendente tagliere e griglia-gocciolatoio per un set di lavoro flessibile, completo e compatto.



KE

QUALITÀ DI FORMA E SOSTANZA



T/P perimetrale









Tre Alto
(8468 000 - pag. 172)



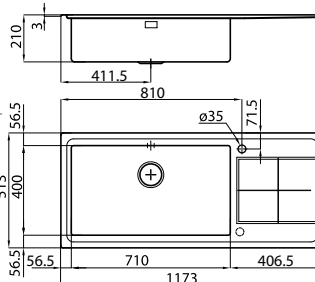

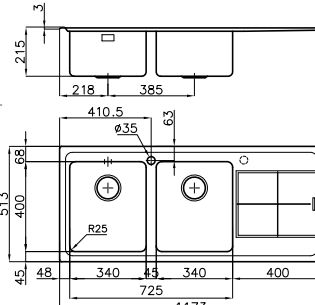

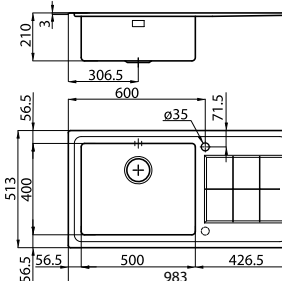



KE
(8492 000 - pag. 176)

miscelatori consigliati

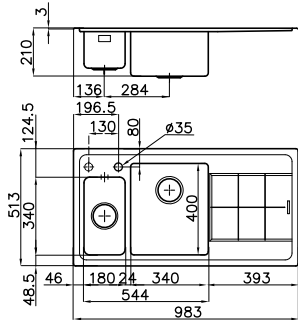
| | Caratteristiche | Versione | Sigla | Prezzo € | Disegno Tecnico |
|---|--|--|-------|------------------------|---|
| <p>Base 90</p>  <p><i>In foto versione sinistra</i></p> <p>Accessori: L3 L4 N2 N3 O2 P2 P4 S T T1 T2 Z Z2 (vedi pag. 87) Pilette automatiche: PA PE PM PL PP PS (v. pag. 148)</p> | <p>AISI 304 spazzolato dimensioni: 1173x513 1 vasca: 710x400 incasso: 1140x480 piletta: 3½"</p> |  <p>2211 051 dx 2211 052 sx</p> | | <p>€ 741,00</p> |  <p>Possibilità secondo foro</p> |
| <p>Base 90</p>  <p><i>In foto versione sinistra</i></p> <p>Accessori: (vedi pag. 87) L4 N2 N3 O2 P2 P4 R T1 T2 Z2 Pilette automatiche: PA PE PM PL PP PS (v. pag. 148)</p> | <p>AISI 304 spazzolato dimensioni: 1173x513 2 vasche: 340x400 incasso: 1140x480 piletta: 3½"</p> |  <p>2222 051 dx 2222 052 sx</p> | | <p>€ 714,00</p> |  <p>Possibilità secondo foro</p> |
| <p>Base 80</p>  <p><i>In foto versione sinistra</i></p> <p>Accessori: L3 L4 N2 N3 O2 P2 P4 S T T1 T2 Z Z2 (vedi pag. 87) Pilette automatiche: PA PE PM PL PP PS (v. pag. 148)</p> | <p>AISI 304 spazzolato dimensioni: 983x513 1 vasca: 500x400 incasso: 950x480 piletta: 3½"</p> |  <p>2263 051 dx 2263 052 sx</p> | | <p>€ 667,00</p> |  <p>Possibilità secondo foro</p> |

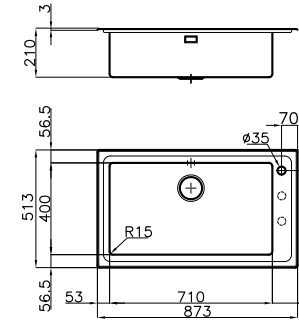
Dotazioni Standard: ganci di fissaggio, guarnizione (no per sottotop), piletta, tropp/pieno e sifone. Imballo in scatola di cartone.

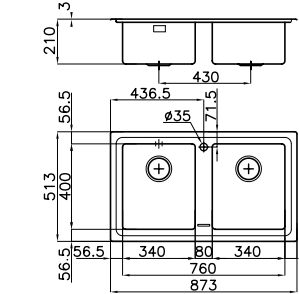
KE

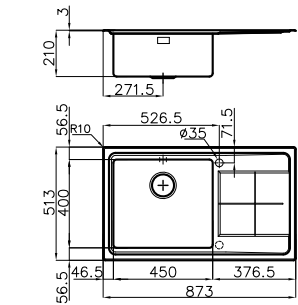
| | Caratteristiche | Versione | Sigla | Prezzo € | Disegno Tecnico |
|---|--|---|---|------------------------|---|
| <p>Base 60/(80)^T (rif. pag. 55)</p>  <p><i>In foto versione sinistra</i></p> <p>Accessori: (vedi pag. 87) L4 N2 N3 O2 P2 P4 R T1 T2 Z2 Pilette automatiche: PA PE PM PL PP PS (v. pag. 148)</p> | <p>AISI 304 spazzolato dimensioni: 983x513 2v: 180x340+340x400 incasso: 950x480 piletta: 3½"</p> |  | <p>2297 051 dx 2297 052 sx</p> | <p>€ 678,00</p> |  <p>Possibilità secondo foro</p> |
| <p>Base 80</p>  <p>Accessori: (vedi pag. 87) L4 N2 N3 O2 P2 P4 S T1 T2 Z2 Pilette automatiche: PA PE PM PL PP PS (v. pag. 148)</p> | <p>AISI 304 spazzolato dimensioni: 873x513 1 vasca: 710x400 incasso: 840x480 piletta: 3½"</p> |  | <p>2287 050</p> | <p>€ 649,00</p> |  <p>Possibilità secondo e terzo foro</p> |
| <p>Base 80/(90)^T (rif. pag. 55)</p>  <p>Accessori: (vedi pag. 87) L4 N2 N3 O2 P2 P4 R T1 T2 Z2 Pilette automatiche: PA PE PM PL PP PS (v. pag. 148)</p> | <p>AISI 304 spazzolato dimensioni: 873x513 2v: 340x400 incasso: 840x480 piletta: 3½"</p> |  | <p>2283 050</p> | <p>€ 611,00</p> |  <p>Possibilità secondo foro</p> |
| <p>Base 60</p>  <p><i>In foto versione sinistra</i></p> <p>Accessori: L3 L4 N2 N3 O2 P2 P4 S T T1 T2 Z Z2 (vedi pag. 87) Pilette automatiche: PA PE PM PL PP PS (v. pag. 148)</p> | <p>AISI 304 spazzolato dimensioni: 873x513 1 vasca: 450x400 incasso: 840x480 piletta: 3½"</p> |  | <p>2280 051 dx 2280 052 sx</p> | <p>€ 569,00</p> |  <p>Possibilità secondo foro</p> |

Dotazioni Standard: ganci di fissaggio, guarnizione (no per sottotop), piletta, troppolieno e sifone. Imballo in scatola di cartone.



In foto l'abbinamento perfetto di lavello e piano cottura KE.

LAVELLI

KE Q4 e Filotop



T/P perimetrale













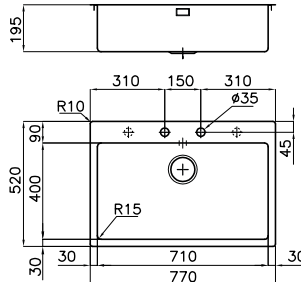





KE
(8492 000 - pag. 176)

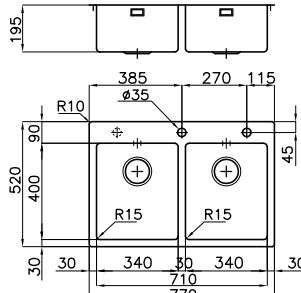











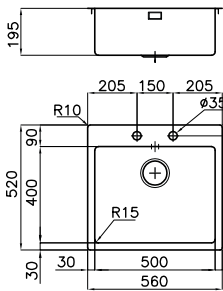



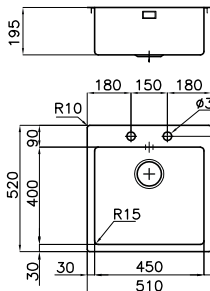

Bert
(8428 100 - pag. 171)

miscelatori consigliati

| | Caratteristiche | Versione | Sigla | Prezzo € | Disegno Tecnico | |
|---|---|--|--|----------|--|--|
| Base 80  | AISI 304 spazzolato dimensioni: 770x520 1 vasca: 710x400 incasso: 750x500 pileta: autom. 3½" PM |  Q4 | 2278 050 | € 765,00 | Le quote perimetrali si riferiscono alla versione filotop  | |
| | |  FT | 2266 050 | € 765,00 | | |
| | AISI 304 spazzolato dimensioni: 770x520 1 vasca: 710x400 incasso FT: vedi sito web incasso FTS: 758x508 pileta: autom. 3½" PM |  FTS | 2266 050 | € 765,00 | | |
| | |  FT | 2266 080 | € 888,00 | | |
| Accessori: L3 L4 N2 N3 O2 P2 P4 S T T1 T2 Z Z2 (vedi pag. 87)  | |  FTS | 2266 080 | € 888,00 | Possibilità terzo e quarto foro | |
| | Base 80  | AISI 304 spazzolato dimensioni: 770x520 2 vasche: 340x400 incasso: 750x500 pileta: autom. 3½" PM |  Q4 | 2279 050 | € 710,00 | Le quote perimetrali si riferiscono alla versione filotop  |
| | | |  FT | 2269 050 | € 710,00 | |
| | | AISI 304 spazzolato dimensioni: 770x520 2 vasche: 340x400 incasso FT: vedi sito web incasso FTS: 758x508 pileta: autom. 3½" PM |  FTS | 2269 050 | € 710,00 | |
|  FT | | | 2269 080 | € 979,00 | | |
| Accessori: N2 N3 O2 P2 P4 R T1 T2 Z2 (vedi pag. 87)  | |  FTS | 2269 080 | € 979,00 | Possibilità terzo foro | |

KE Q4 e Filotop

| | Caratteristiche | Versione | Sigla | Prezzo € | Disegno Tecnico |
|--|--|---|----------|----------|--|
| Base 60  | AISI 304 spazzolato dimensioni: 560x520 1 vasca: 500x400 incasso: 540x500 piletta: autom. 3½" PM |  | 2272 050 | € 663,00 | Le quote perimetrali si riferiscono alla versione filotop  |
| | AISI 304 spazzolato dimensioni: 560x520 1 vasca: 500x400 incasso FT: vedi sito web incasso FTS: 548x508 piletta: autom. 3½" PM |  | 2265 050 | € 663,00 | |
| | |  | 2265 050 | € 663,00 | |
| | versione Vintage  |  | 2265 080 | € 743,00 | |
| | |  | 2265 080 | € 743,00 | |
| Accessori: L3 L4 N2 N3 O2 P2 P4 S T T1 T2 Z Z2 | | | | | |
| Base 60  | AISI 304 spazzolato dimensioni: 510x520 1 vasca: 450x400 incasso: 490x500 piletta: autom. 3½" PM |  | 2274 050 | € 634,00 | Le quote perimetrali si riferiscono alla versione filotop  |
| | AISI 304 spazzolato dimensioni: 510x520 1 vasca: 450x400 incasso FT: vedi sito web incasso FTS: 498x508 piletta: autom. 3½" PM |  | 2264 050 | € 633,00 | |
| | |  | 2264 050 | € 633,00 | |
| | versione Vintage  |  | 2264 080 | € 719,00 | |
| | |  | 2264 080 | € 719,00 | |
| Accessori: L3 L4 N2 N3 O2 P2 P4 S T T1 T2 Z Z2 | | | | | |





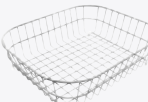

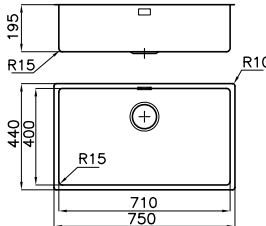

Dotazioni Standard: ganci di fissaggio, guarnizione (no per sottotop), piletta, tropp/pieno e sifone. Imballo in scatola di cartone.

accessori

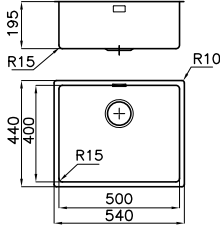

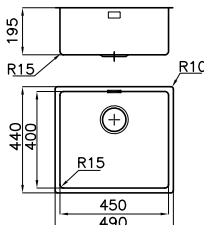
| | | | | | |
|---|---|---|--|---|--|
|  | L3 Tagliere Twin 41x41 cm 8644 004 € 242,00 |  | L4 Tagliere cristallo 23x41 cm 8631 300 € 96,00 |  | M Tagliere scorrevole 30x54 cm 8643 000 € 114,00 |
|  | N2 Tagliere in HDPE 27,2x42,5 cm 8657 001 € 74,00 |  | N3 Tagliere Twin in HDPE 31,7x42,5 cm 8644 101 € 109,00 |  | O2 Vaschetta bianca 27,2x41,4 cm 8153 100 € 39,00 |
|  | P4 Kit tagliere con vaschetta scolapasta in acciaio inox 8644 044 € 278,00 |  | R Cestello Inox 34x40 cm 8611 000 € 50,00 |  | S Cestello Inox 40x40 8612 000 € 58,00 Cestello bianco 40x40 8612 100 € 37,00 |
|  | T1 Cestello portapiatti 25x42,5 cm 8100 201 € 87,00 |  | T2 ** Cestello portapiatti inox 21,4x37,9 cm 8100 303 € 93,00 |  | Z * Scolapasta inox 25x36 cm 8154 000 € 187,00 |
| | | | |  | P2 ** Kit grattugie con anello-supporto e vaschetta raccogli vivande - 8159 101 € 146,00 |
| | | | |  | T * Griglia portapiatti 25x35 cm 8100 154 € 69,00 |
| | | | |  | Z2 ** Vaschetta forata inox 21,5x38 cm 8151 000 € 279,00 |

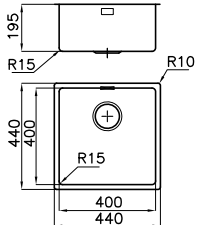
*utilizzabile solo in abbinamento al tagliere L3 **utilizzabile solo in abbinamento al tagliere N3

KE - Vasche Filotop

| | Caratteristiche | Versione | Sigla | Prezzo € | Disegno Tecnico |
|---|--|----------|----------|----------|---|
|  | AISI 304 spazzolato dimensioni: 750x440 1 vasca: 710x400 incasso FT: v. sito web* incasso FTS: 730x420* piletta: 3/2" | FT | 2157 050 | € 558,00 |  |
| | | FTS | 2157 050 | | |
| | versione Vintage | FT | 2157 080 | € 905,00 | |
| |  | FTS | 2157 080 | | |
| * il foro incasso necessita di intaglio per l'alloggio del troppo-pieno (vedi sito web) | | | | | |
| Accessori: L3 L4 N2 N3 O2 P2 P4 S T T1 T2 Z Z2 Pilette automatiche: PA PE PM PL PP PS (v. pag. 148) | | | | | |
|  | AISI 304 spazzolato dimensioni: 540x440 1 vasca: 500x400 incasso FT: v. sito web* incasso FTS: 520x420* piletta: 3/2" | FT | 2155 050 | € 410,00 |  |
| | | FTS | 2155 050 | | |
| | versione Vintage | FT | 2155 080 | € 662,00 | |
| |  | FTS | 2155 080 | | |
| * il foro incasso necessita di intaglio per l'alloggio del troppo-pieno (vedi sito web) | | | | | |
| Accessori: L3 L4 N2 N3 O2 P2 P4 S T T1 T2 Z Z2 Pilette automatiche: PA PE PM PL PP PS (v. pag. 148) | | | | | |
|  | AISI 304 spazzolato dimensioni: 490x440 1 vasca: 450x400 incasso FT: v. sito web* incasso FTS: 470x420* piletta: 3/2" | FT | 2154 050 | € 398,00 |  |
| | | FTS | 2154 050 | | |
| | versione Vintage | FT | 2154 080 | € 623,00 | |
| |  | FTS | 2154 080 | | |
| * il foro incasso necessita di intaglio per l'alloggio del troppo-pieno (vedi sito web) | | | | | |
| Accessori: L3 L4 N2 N3 O2 P2 P4 S T T1 T2 Z Z2 Pilette automatiche: PA PE PM PL PP PS (v. pag. 148) | | | | | |
|  | AISI 304 spazzolato dimensioni: 440x440 1 vasca: 400x400 incasso FT: v. sito web* incasso FTS: 420x420* piletta: 3/2" | FT | 2156 050 | € 388,00 |  |
| | | FTS | 2156 050 | | |
| | versione Vintage | FT | 2156 080 | € 623,00 | |
| |  | FTS | 2156 080 | | |
| * il foro incasso necessita di intaglio per l'alloggio del troppo-pieno (vedi sito web) | | | | | |
| Accessori: L3 L4 N2 N3 O2 P2 P4 S T T1 T2 Z Z2 Pilette automatiche: PA PE PM PL PP PS (v. pag. 148) | | | | | |

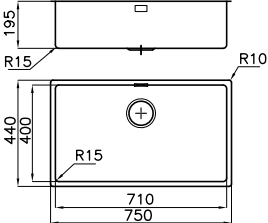
KE - Vasche Filotop Gun Metal



| | Caratteristiche | Versione | Sigla | Prezzo € | Disegno Tecnico |
|--|--|----------|----------|-------------------|---|
| Base 80  | AISI 304 Gun Metal dimensioni: 750x440 1 vasca: 710x400 incasso FT: v. sito web* incasso FTS: 730x420* piletta: 3½" | FT | 2157 056 | € 1.280,00 |  |
| | | FTS | 2157 056 | | |
| | versione Vintage  NEW | FT | 2157 086 | € 1.501,00 | |
| | | FTS | 2157 086 | | |

* il foro incasso necessita di intaglio per l'alloggio del troppo-pieno (vedi sito web)

Accessori: **L3 L4 N2 N3 O2 P2 P4 S T T1**

T2 Z Z2 (v. pag. 87)

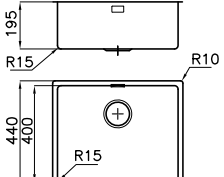
Pilette automatiche: **PG** (v. pag. 149)

| | | | | | |
|--|--|-----|----------|-------------------|---|
| Base 60  | AISI 304 Gun Metal dimensioni: 540x440 1 vasca: 500x400 incasso FT: v. sito web* incasso FTS: 520x420* piletta: 3½" | FT | 2155 056 | € 928,00 |  |
| | | FTS | 2155 056 | | |
| | versione Vintage  NEW | FT | 2155 086 | € 1.092,00 | |
| | | FTS | 2155 086 | | |

* il foro incasso necessita di intaglio per l'alloggio del troppo-pieno (vedi sito web)

Accessori: **L3 L4 N2 N3 O2 P2 P4 S T T1**

T2 Z Z2 (v. pag. 87)

Pilette automatiche: **PG** (v. pag. 149)

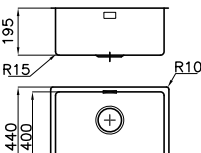
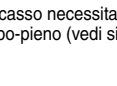

| | | | | | |
|--|--|-----|----------|-----------------|---|
| Base 60  | AISI 304 Gun Metal dimensioni: 490x440 1 vasca: 450x400 incasso FT: v. sito web* incasso FTS: 470x420* piletta: 3½" | FT | 2154 056 | € 919,00 |  |
| | | FTS | 2154 056 | | |
| | versione Vintage  NEW | FT | 2154 086 | € 919,00 | |
| | | FTS | 2154 086 | | |

* il foro incasso necessita di intaglio per l'alloggio del troppo-pieno (vedi sito web)

Accessori: **L3 L4 N2 N3 O2 P2 P4 S T T1**

T2 Z Z2 (v. pag. 87)

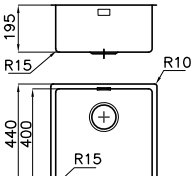
Pilette automatiche: **PG** (v. pag. 149)

| | | | | | |
|--|--|-----|----------|-----------------|---|
| Base 45  | AISI 304 Gun Metal dimensioni: 440x440 1 vasca: 400x400 incasso FT: v. sito web* incasso FTS: 420x420* piletta: 3½" | FT | 2156 056 | € 887,00 |  |
| | | FTS | 2156 056 | | |
| | versione Vintage  NEW | FT | 2156 086 | € 991,00 | |
| | | FTS | 2156 086 | | |

* il foro incasso necessita di intaglio per l'alloggio del troppo-pieno (vedi sito web)

Accessori: **L3 L4 N2 N3 O2 P2 P4 S T T1**

T2 Z Z2 (v. pag. 87)

Pilette automatiche: **PG** (v. pag. 149)

Stripe

UN LAVELLO "GESSATO": PURA ELEGANZA, MA ANCHE TANTA FUNZIONALITÀ







T/P perimetrale







NYC
(8486 000 - pag. 170)

Milanello
(8425 100 - pag. 164)

miscelatori consigliati

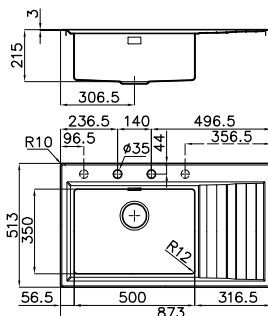
| | Caratteristiche | Versione | Sigla | Prezzo € | Disegno Tecnico |
|---|---|---|------------------------------------|------------------------|-------------------------------|
| <p>Base 80/(90)^T (rif. pag. 55)</p>  <p>In dotazione: elemento portacoltelli Accessori opzionali: B6 T6 (v. pag. 91)</p> | <p>AISI 304 spazzolato dimensioni: 1173x513 1 vasca: 750x350 incasso: 1140x480 piletta: autom. 3½" PM</p> |  | <p>4504 051 dx 4504 052 sx</p> | <p>€ 990,00</p> | |
| <p>Base 80/(90)^T (rif. pag. 55)</p>  <p>Accessori: B6 T6 (v. pag. 91)</p> | <p>AISI 304 spazzolato dimensioni: 1173x513 2 vasche: 365x350 incasso: 1140x480 piletta: autom. 3½" PM</p> |  | <p>4503 051 dx 4503 052 sx</p> | <p>€ 933,00</p> | <p>Possibilità terzo foro</p> |

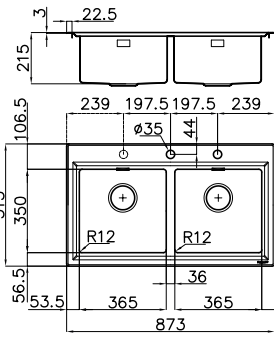
Stripe

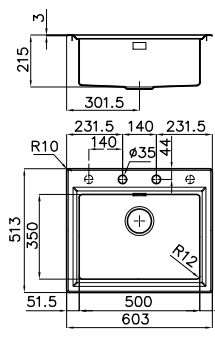
| | Caratteristiche | Versione | Sigla | Prezzo € | Disegno Tecnico |
|--|--|--|----------------------------|-----------------|--|
| Base 60 | AISI 304 spazzolato dimensioni: 873x513 1 vasca: 500x350 incasso: 840x480 piletta: autom. 3½" PM |  SF | 4500 051 dx 4500 052 sx | € 666,00 |  |
| Accessori: B6 T6 | Possibilità terzo e quarto foro | | | | |
| Base 80/(90)^T (rif. pag. 55) | AISI 304 spazzolato dimensioni: 873x513 2 vasche: 365x350 incasso: 840x480 piletta: autom. 3½" PM |  SF | 4502 050 | € 908,00 |  |
| Accessori: B6 T6 | Possibilità terzo foro | | | | |
| Base 60 | AISI 304 spazzolato dimensioni: 603x513 1 vasca: 500x350 incasso: 570x480 piletta: autom. 3½" PM |  SF | 4505 050 | € 644,00 |  |
| Accessori: B6 T6 | Possibilità terzo e quarto foro | | | | |

Dotazioni Standard: ganci di fissaggio, guarnizione (no per sottotop), piletta, troppo/pieno e sifone. Imballo in scatola di cartone.



L'originale ed elegante gocciolatoio a strisce è al contempo superficie di appoggio e zona di scolo dell'acqua. Il tagliere riprende il motivo di design del lavello.



Il modello con vasca grande larga 75 cm ha in dotazione un pratico accessorio: il portacoltelli. Un elemento coerente con il concetto di lavello pensato come centro di lavoro.

accessori



B6
Tagliere
26x36,6 cm
8643 117
€ 71,00



T6
Griglia portapiatti
inox 23x37,5
8100 305
€ 83,00

Triplo Invaso workstation **NEW**

UN CENTRO FUNZIONALE CHE SPARISCE NEL TOP

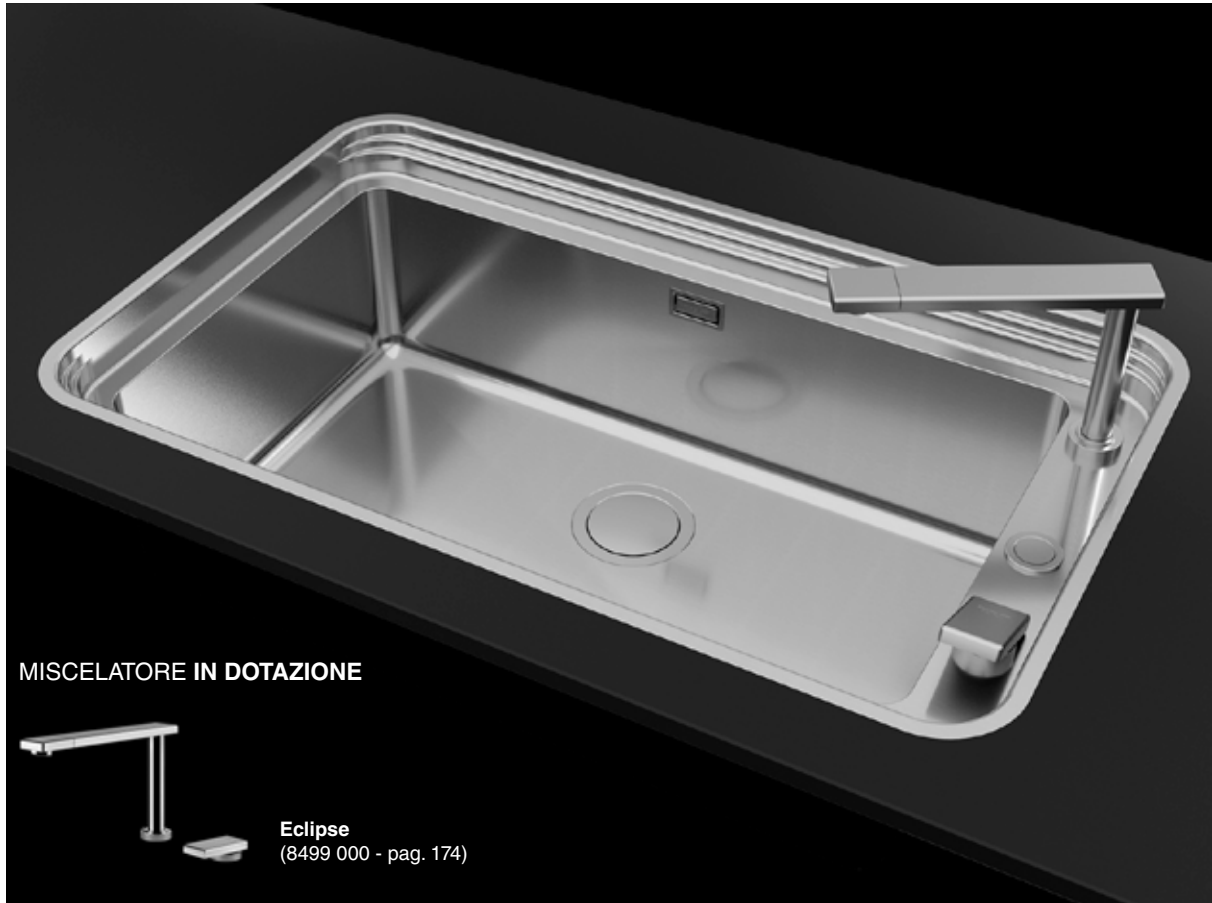

Piletta SPACE



T/P perimetrale









Piletta Salva spazio



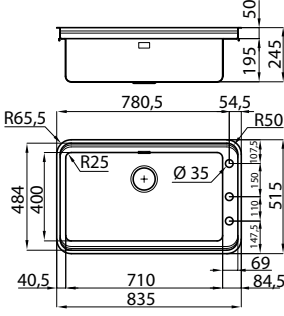



MISCELATORE IN DOTAZIONE



Eclipse
(8499 000 - pag. 174)

| | Caratteristiche | Versione | Sigla | Prezzo € | Disegno Tecnico |
|---|--|---|----------|-------------------|---|
| Base 80  | AISI 304 spazzolato dimensioni: 835x515 1 vasca: 710x400 incasso FT: v. sito web* incasso FTS: 820x500 / R58 piletta: automatica SPACE 3½" PP |  FT | 1491 059 | € 1.959,00 |  |
| | |  FTS | 1491 059 | | |
| IN DOTAZIONE: | | | | | |
| |  | miscelatore Eclipse (cod. 8499 000) | | | |
| |  | 2 griglie black TI (cod. 8100 603) | | | |
| Accessori: L4 M2 N2 O2 S U2 | | | | | |

accessori

| | |
|---|--|
|  <p>L4 Tagliere cristallo 23x41 cm 8631 300 € 96,00</p> |  <p>M2 Tagliere 28x48 8643 115 € 66,00</p> |
|  <p>N2 Tagliere in HDPE 27,2x42,5 cm 8657 001 € 74,00</p> |  <p>O2 Vaschetta bianca 27,2x41,4 cm 8153 100 € 39,00</p> |
|  <p>S Cestello Inox 40x40 8612 000 € 58,00 Cestello bianco 40x40 8612 100 € 37,00</p> |  <p>U2 Griglia portapiatti inox 23x47 8100 115 € 78,00</p> |



il lavello Triplo Invaso sparisce nel piano di lavoro, grazie al miscelatore abbattibile Eclipse, e alle griglie Black, che chiudono interamente la vasca.



Serie Evo

NEW

L'EVOLUZIONE DELLA FUNZIONALITÀ

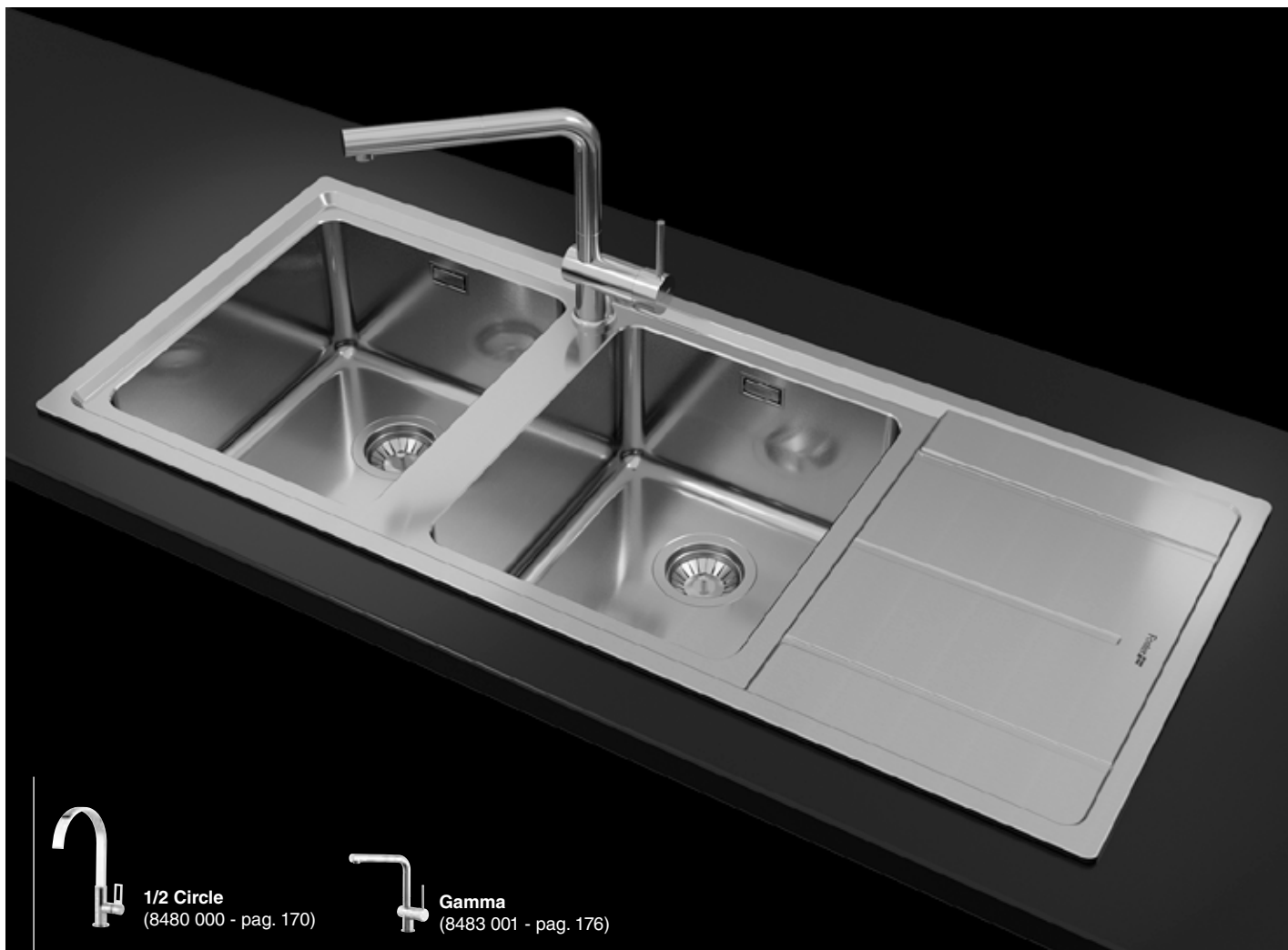

1/2 Circle
(8480 000 - pag. 170)



Gamma
(8483 001 - pag. 176)

miscelatori consigliati

| | Caratteristiche | Versione | Sigla | Prezzo € | Disegno Tecnico |
|--|-----------------|----------|-------|----------|-----------------|
|--|-----------------|----------|-------|----------|-----------------|

Base 90



AISI 304 spazzolato
dimensioni: **1160x500**
1 vasca: **730x400**
incasso: 1140x480
piletta: 3½"
T/P perimetrale



3216 051 dx
3216 052 sx

€ 426,00

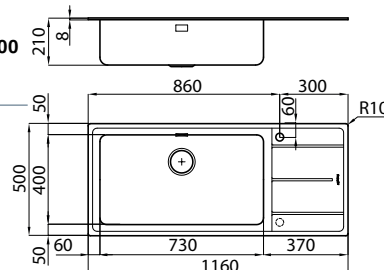

Possibilità secondo foro

Accessori:

G L3 L4 L5 M N2 N3 O2 P2 P4
S T2 T4

Pilette automatiche: PA PE PM PL PP PS
(v. pag. 148)

Base 80(90)^T (rif. pag. 55)



AISI 304 spazzolato
dimensioni: **1160x500**
2 vasche: **340x400**
incasso: 1140x480
piletta: 3½"
T/P perimetrale



3212 051 dx
3212 052 sx

€ 499,00

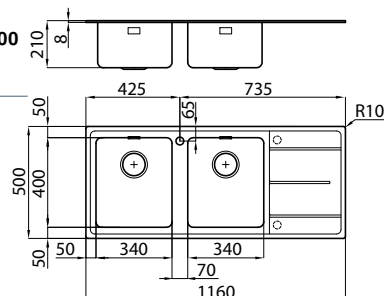

Possibilità secondo e terzo foro





Accessori:

A L3 L4 L5 M N2 N3 O2 P2 P4
R T2 T4

Pilette automatiche: PA PE PM PL PP PS
(v. pag. 148)

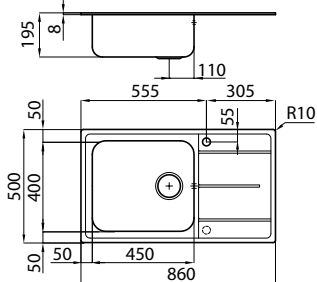

Dotazioni Standard: ganci di fissaggio, guarnizione (no per sottotop), piletta, troppopieno e sifone. Imballo in scatola di cartone.

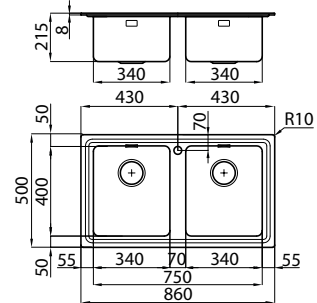
Serie Evo

| | Caratteristiche | Versione | Sigla | Prezzo € | Disegno Tecnico |
|--|--|---|-------------|-----------------|---|
| Base 60  | AISI 304 spazzolato dimensioni: 860x500 1 vasca: 450x400 incasso: 840x480 piletta: 3½" |  | 3218 001 dx | € 182,00 |  |
| | | | 3218 002 sx | | |
| Accessori: G L3 L4 L5 M N2 N3 O2 P2 P4 S T2 T4 | | | | | |
| Pilette automatiche: PA PE PM PL PP PS (v. pag. 148) | | | | | |
| Base 80/(90)^T (rif. pag. 55)  | AISI 304 spazzolato dimensioni: 860x400 2 vasche: 340x400 incasso: 840x480 piletta: 3½" T/P perimetrale |  | 3274 050 | € 461,00 |  |
| | | | | | |
| Accessori: A L3 L4 L5 M N2 N3 O2 P2 P4 R T2 T4 | | | | | |
| Pilette automatiche: PA PE PM PL PP PS (v. pag. 148) | | | | | |

Dotazioni Standard: ganci di fissaggio, guarnizione (no per sottotop), piletta, troppo/pieno e sifone. Imballo in scatola di cartone.

accessori

| | | | |
|--|---|---|--|
|  <p>A Tagliere 34x40 8647 000 € 92,00</p> |  <p>G Tagliere 40x40 8646 000 € 110,00</p> <p>ad esaurimento</p> |  <p>L3 Tagliere Twin 41x41 cm 8644 004 € 242,00</p> | |
|  <p>L4 Tagliere cristallo 23x41 cm 8631 300 € 96,00</p> |  <p>L5 Tagliere cristallo 29x54 cm 8633 300 € 110,00</p> |  <p>M Tagliere scorrevole 30x54 cm 8643 000 € 114,00</p> |  <p>M2 Tagliere 28x48 8643 115 € 66,00</p> |
|  <p>N2 Tagliere in HDPE 27,2x42,5 cm 8657 001 € 74,00</p> |  <p>N3 Tagliere Twin in HDPE 31,7x42,5 cm 8644 101 € 109,00</p> |  <p>O2 Vaschetta bianca 27,2x41,4 cm 8153 100 € 39,00</p> |  <p>P2 ** Kit grattugie con anello-supporto e vaschetta raccogli vivande - 8159 101 € 146,00</p> |
|  <p>P4 Kit tagliere con vaschetta scolapasta in acciaio inox 8644 044 € 278,00</p> |  <p>Q Scolapasta bianco 17x32 cm 8151 100 € 32,00</p> |  <p>R Cestello Inox 34x40 cm 8611 000 € 50,00</p> |  <p>S Cestello Inox 40x40 8612 000 € 58,00 Cestello bianco 40x40 8612 100 € 37,00</p> |
|  <p>T2 ** Cestello portapiatti inox 21,4x37,9 cm 8100 303 € 93,00</p> |  <p>T4 Griglia portapiatti inox 25x43 cm 8100 301 € 87,00</p> |  <p>U2 Griglia portapiatti inox 23x47 8100 115 € 78,00</p> |  <p>Z * Scolapasta inox 25x36 cm 8154 000 € 187,00</p> |

*utilizzabile solo in abbinamento al tagliere L3 **utilizzabile solo in abbinamento al tagliere N3

LAVELLI

KS

QUALITÀ E PRATICITÀ







KS Plus
(8522 000 - pag. 184)





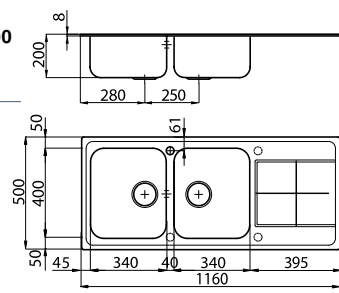

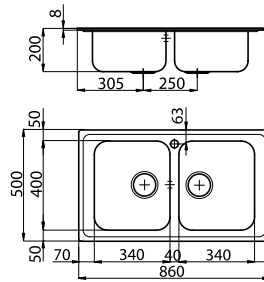
NYC
(8486 000 - pag. 170)

miscelatori consigliati

| | Caratteristiche | Versione | Sigla | Prezzo € | Disegno Tecnico |
|---|--|---|---|------------------------|---|
| <p>Base 80</p>  <p><i>In foto versione sinistra</i></p> <p>Accessori: (vedi pag. 97) A L4 L5 M N2 N3 O2 P2 P4 R T2 T4</p> <p>Pilette automatiche: PR PQ PC (vedi pag. 149)</p> | <p>AISI 304 spazzolato dimensioni: 1160x500 2 vasche: 340x400 incasso: 1140x480 piletta: 3½"</p> |  | <p>2112 061 dx 2112 062 sx</p> | <p>€ 385,00</p> |  <p>Possibilità secondo, terzo e quarto foro</p> |
| <p>Base 80/(90)T (rif. pag. 55)</p>  <p>Accessori: (vedi pag. 97) A L4 L5 M N2 N3 O2 P2 P4 R T2 T4</p> | <p>AISI 304 spazzolato dimensioni: 860x500 2 vasche: 340x400 incasso: 840x480 piletta: 3½"</p> |  | <p>2182 060</p> | <p>€ 375,00</p> |  |

Dotazioni Standard: ganci di fissaggio, guarnizione (no per sottotop), piletta, troppo/pieno e sifone. Imballo in scatola di cartone.

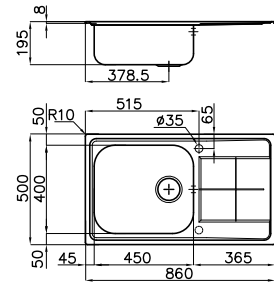
KS

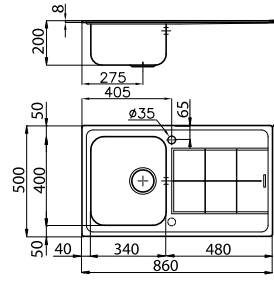
| | Caratteristiche | Versione | Sigla | Prezzo € | Disegno Tecnico |
|---|--|---|-------------|-----------------|---|
| Base 60  <i>In foto versione sinistra</i> Accessori: E L4 L5 M N2 N3 O2 P2 P4 S T2 T4 Pilette automatiche: PR PQ PC (vedi pag. 149) | AISI 304 spazzolato dimensioni: 860x500 1 vasca: 450x400 incasso: 840x480 piletta: 3½" |  | 2180 061 dx | € 291,00 |  Possibilità secondo foro |
| | | | 2180 062 sx | | |
| Base 45  <i>In foto versione sinistra</i> Accessori: A L4 L5 M N2 N3 O2 P2 P4 R T2 T4 Pilette automatiche: PR PQ PC (vedi pag. 149) | AISI 304 spazzolato dimensioni: 860x500 1 vasca: 340x400 incasso: 840x480 piletta: 3½" |  | 2181 061 dx | € 258,00 |  Possibilità secondo foro |
| | | | 2181 062 sx | | |

Dotazioni Standard: ganci di fissaggio, guarnizione (no per sottotop), piletta, troppo/pieno e sifone. Imballo in scatola di cartone.

accessori

| | | | |
|---|--|--|---|
|  <p>A Tagliere 34x40 8647 000 € 92,00</p> |  <p>E Tagliere 45x40 8655 000 € 76,00</p> |  <p>L4 Tagliere cristallo 23x41 cm 8631 300 € 96,00</p> | |
|  <p>L5 Tagliere cristallo 29x54 cm 8633 300 € 110,00</p> |  <p>M Tagliere scorrevole 30x54 8643 000 € 114,00</p> |  <p>N2 Tagliere in HDPE 27,2x42,5 cm 8657 001 € 74,00</p> |  <p>N3 Tagliere Twin in HDPE 31,7x42,5 cm 8644 101 € 109,00</p> |
|  <p>O2 Vaschetta bianca 27,2x41,4 cm 8153 100 € 39,00</p> |  <p>P2 ** Kit grattugie con anello-supporto e vaschetta raccogli vivande - 8159 101 € 146,00</p> |  <p>P4 Kit tagliere con vaschetta scolapasta in acciaio inox 8644 044 € 278,00</p> |  <p>Q Scolapasta bianco 17x32 cm 8151 100 € 32,00</p> |
|  <p>R Cestello Inox 34x40 cm 8611 000 € 50,00</p> |  <p>S Cestello Inox 40x40 8612 000 € 58,00 Cestello bianco 40x40 8612 100 € 37,00</p> |  <p>T2 ** Cestello portapiatti inox 21,4x37,9 cm 8100 303 € 93,00</p> |  <p>T4 Griglia portapiatti inox 25x43 cm 8100 301 € 87,00</p> |

**utilizzabile solo in abbinamento al tagliere N3

LAVELLI

Elettra

L'ELEGANZA DELLA SEMPLICITÀ









Luisa
(8482 000 - pag. 177)

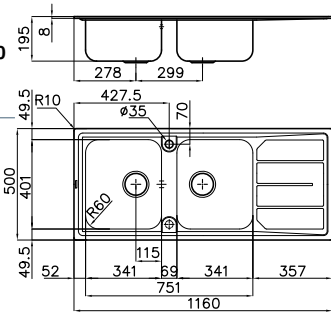

F2000 Basso
(8459 000 - pag. 186)

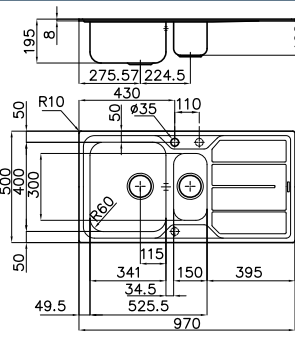
miscelatori consigliati

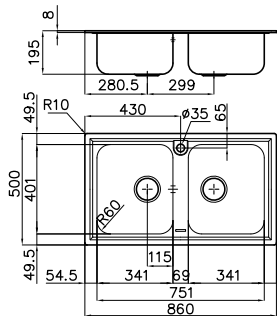
| | Caratteristiche | Versione | Sigla | Prezzo € | Disegno Tecnico |
|---|---|--|-------|------------------------|---|
| <p>Base 80(90)^T (rif. pag. 55)</p>  <p><i>In foto versione sinistra</i></p> <p>Accessori: A L4 M N2 O2 R T4 Pilette automatiche: PR PC (v. pag. 149)</p> | <p>AISI 304 spazzolato dimensioni: 1160x500 2 vasche: 341x401 incasso: 1140x480 piletta: 3/2"</p> | <p> 5812 061 dx 5812 062 sx</p> | | <p>€ 326,00</p> |  <p>Possibilità secondo foro</p> |
| <p>Base 60</p>  <p><i>In foto versione sinistra</i></p> <p>Accessori: A L4 M N2 O2 Q R T4 X Pilette automatiche: PR PC (v. pag. 149)</p> | <p>AISI 304 spazzolato dimensioni: 970x500 2v: 341x400 + 150x300 incasso: 950x480 piletta: 3/2"</p> | <p> 5197 061 dx 5197 062 sx</p> | | <p>€ 306,00</p> |  <p>Possibilità secondo e terzo foro</p> |
| <p>Base 80(90)^T (rif. pag. 55)</p>  <p>Accessori: A L4 M N2 O2 R T4</p> | <p>AISI 304 spazzolato dimensioni: 860x500 2 vasche: 341x401 incasso: 840x480 piletta: 3/2"</p> | <p> 5886 060</p> | | <p>€ 302,00</p> |  |

Dotazioni Standard: ganci di fissaggio, guarnizione (no per sottotop), piletta, tropp/pieno e sifone. Imballo in scatola di cartone.

Elettra

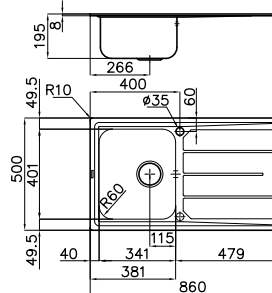
| | Caratteristiche | Versione | Sigla | Prezzo € | Disegno Tecnico |
|----------------|--|---|----------------------------|-----------------|---|
| Base 45 | AISI 304 spazzolato dimensioni: 860x500 1 vasca: 341x401 incasso: 840x480 piletta: 3½" |  STD | 5186 061 dx 5186 062 sx | € 217,00 |  |



In foto versione sinistra

Accessori: **A L4 M N2 O2 R T4**
Pilette automatiche: **PR PC** (v. pag. 149)

Inseribili miscelatori con base d'appoggio max ø 45 mm
Possibilità secondo foro

Dotazioni Standard: ganci di fissaggio, guarnizione (no per sottotop), piletta, troppo/pieno e sifone. Imballo in scatola di cartone.



Grandi e profonde vasche in un design pratico e funzionale.

accessori



A
Tagliere
34x40
8647 000
€ 92,00



L4
Tagliere cristallo
23x41 cm
8631 300
€ 96,00



M
Tagliere scorrevole
30x54
8643 000
€ 114,00



N2
Tagliere in HDPE
27,2x42,5 cm
8657 001
€ 74,00



O2
Vaschetta bianca
27,2x41,4 cm
8153 100
€ 39,00



Q
Scolapasta bianco
17x32 cm
8151 100
€ 32,00



R
Cestello Inox
34x40 cm
8611 000
€ 50,00



T4
Griglia portapiatti
inox 25x43 cm
8100 301
€ 87,00



X
Scolapasta inox
17x32 cm
8154 043
€ 146,00

LAVELLI

FM e FM Marine

LA ROBUSTEZZA DEL LAVELLO SENZA SALDATURE



AISI 316
Acciaio inox
AISI 316



Gamma 3 vie - AISI 316
(8496 100 - pag. 173)





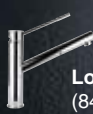





NYC
(8486 000 - pag. 170)

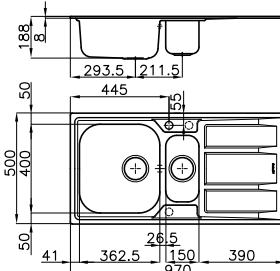

Lorenzo
(8466 000 - pag. 177)

miscelatori consigliati

| | Caratteristiche | Versione | Sigla | Prezzo € | Disegno Tecnico |
|---|--|---|-----------------|-----------------|---|
| Base 80/(90)^T (rif. pag. 55)  | AISI 316 spazzolato dimensioni: 1160x500 2 vasche: 362,5x400 incasso: 1140x480 piletta: 3½" |  STD | 1972 961 dx | € 259,00 |  |
| | |  AISI 316 | 1972 962 sx | | |
| | AISI 304 spazzolato dimensioni: 1160x500 2 vasche: 362,5x400 incasso: 1140x480 piletta: 3½" |  STD | 1972 061 dx | € 225,00 | |
| | |  STD | 1972 062 sx | | |
| Base 60/(80)^T (rif. pag. 55)  | AISI 316 spazzolato dimensioni: 970x500 2v: 362,5x400+150x300 incasso: 950x480 piletta: 3½" |  STD | 1973 961 dx | € 300,00 |  |
| | |  AISI 316 | 1973 962 sx | | |
| | AISI 304 spazzolato dimensioni: 970x500 2v: 362,5x400+150x300 incasso: 950x480 piletta: 3½" |  STD | 1973 061 dx | € 265,00 | |
| | |  STD | 1973 062 sx | | |
| AISI 304 microfoster dimensioni: 970x500 2v: 362,5x400+150x300 incasso: 950x480 piletta: 3½" |  STD | 1973 461 dx | € 316,00 | | |
| |  microfoster | 1973 462 sx | | | |

In foto versione sinistra

Accessori: **L4 M N2 R T4**

Pilette automatiche: **PR PC** (v. pag. 149)

Possibilità secondo foro

In foto versione sinistra





Accessori: **M N2 Q R T4 X**

Pilette automatiche: **PR PC** (v. pag. 149)



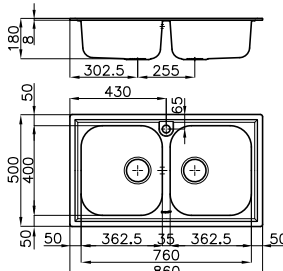

Possibilità secondo e terzo foro

Dotazioni Standard: ganci di fissaggio, guarnizione (no per sottotop), piletta, troppo/pieno e sifone. Imballo in scatola di cartone.

FM e FM Marine

| | Caratteristiche | Versione | Sigla | Prezzo € | Disegno Tecnico |
|---|--|---|----------|-----------------|---|
| Base 80(90)^T (rif. pag. 55)  | AISI 316 spazzolato dimensioni: 860x500 2 vasche: 362,5x400 incasso: 840x480 piletta: 3½" |  NEW  | 1974 960 | € 229,00 |  |
| | AISI 304 spazzolato dimensioni: 860x500 2 vasche: 362,5x400 incasso: 840x480 piletta: 3½" |  | 1974 060 | € 202,00 | |

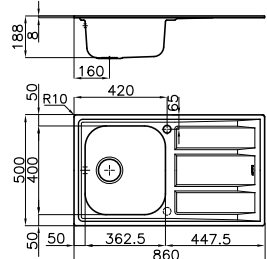
Accessori: **L4 M N2 R T4**

| | | | | | |
|--|---|---|----------------------------|-----------------|---|
| Base 45  | AISI 316 spazzolato dimensioni: 860x500 1 vasca: 362,5x400 incasso: 840x480 piletta: 3½" |  NEW  | 1971 961 dx 1971 962 sx | € 184,00 |  |
| | AISI 304 spazzolato dimensioni: 860x500 1 vasca: 362,5x400 incasso: 840x480 piletta: 3½" |  | 1971 061 dx 1971 062 sx | € 156,00 | |

In foto versione sinistra

Accessori: **L4 M N2 R T4**

Pilette automatiche: **PR PC** (v. pag. 149)

Possibilità secondo foro

Dotazioni Standard: ganci di fissaggio, guarnizione (no per sottotop), piletta, tropp/pieno e sifone. Imballo in scatola di cartone.

Vasche profonde

Vasche capienti e profonde 19 cm, inserite in un involucro salvagoccia di ampio spessore, per questo lavello di grande robustezza e praticità.



accessori



L4
Tagliere cristallo
23x41 cm
8631 300
€ 96,00



M
Tagliere scorrevole
30x54
8643 000
€ 114,00



N2
Tagliere in HDPE
27,2x42,5 cm
8657 001
€ 74,00



Q
Scolapasta bianco
17x32 cm
8151 100
€ 32,00

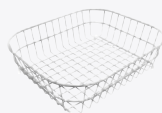

R
Cestello Inox
34x40 cm
8611 000
€ 50,00



T4
Griglia portapiatti
inox 25x43 cm
8100 301
€ 87,00



X
Scolapasta inox
17x32 cm
8154 043
€ 146,00

Big Bowl

TUTTA LA PRATICITÀ DI UNA GRANDE CAPIENTE VASCA











Delta
(8441 000 - pag. 183)

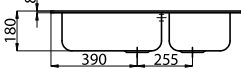

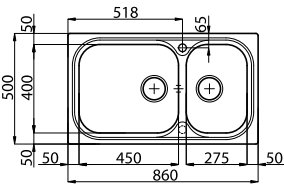

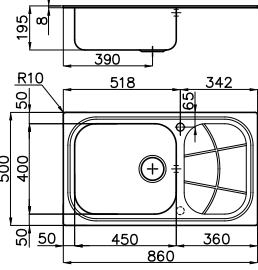
Luisa
(8482 000 - pag. 177)

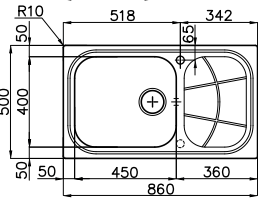

miscelatori consigliati

| | Caratteristiche | Versione | Sigla | Prezzo € | Disegno Tecnico |
|---|---|---|-------------|----------|---|
| Base 90  <p><i>In foto versione sinistra</i></p> | AISI 304 spazzolato dimensioni: 860x500 2v: 450x400+275x400 incasso: 840x480 piletta: 3½" |  | 1562 001 dx | € 252,00 | Le quote perimetrali si riferiscono alla versione d'incasso standard  |
| | | | 1562 002 sx | | |
| Base 60  <p><i>In foto versione sinistra</i></p> | AISI 304 spazzolato dimensioni: 873x513 2v: 450x400+275x400 incasso: 840x480 piletta: 3½" |  | 1072 061 dx | € 298,00 |  |
| | | | 1072 062 sx | | |
| Accessori: E L4 M N2 S T3 T4 (vedi pag. 103) Pilette automatiche: PR PQ PC (v. pag. 149) | | | | | |
| Base 60  <p><i>In foto versione sinistra</i></p> | AISI 304 spazzolato dimensioni: 860x500 1 vasca: 450x400 incasso: 840x480 piletta: 3½" |  | 1561 201 dx | € 205,00 | Le quote perimetrali si riferiscono alla versione d'incasso standard  |
| | | | 1561 202 sx | | |
| Base 60  <p><i>In foto versione sinistra</i></p> | AISI 304 spazzolato dimensioni: 873x513 1 vasca: 450x400 incasso: 840x480 piletta: 3½" |  | 1071 061 dx | € 252,00 |  |
| | | | 1071 062 sx | | |
| Accessori: E L4 M N2 S T4 Pilette automatiche: PR PQ PC (v. pag. 149) | | | | | |

Dotazioni Standard: ganci di fissaggio, guarnizione (no per sottotop), piletta, tropp/pieno e sifone. Imballo in scatola di cartone.

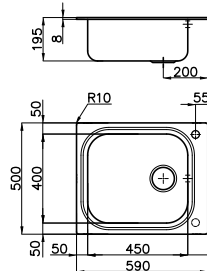
Big Bowl

| | Caratteristiche | Versione | Sigla | Prezzo € | Disegno Tecnico |
|---|--|---|-------------|-----------------|---|
| Base 60  In foto versione sinistra | AISI 304 spazzolato dimensioni: 590x500 1 vasca: 450x400 incasso: 570x480 piletta: 3½" |  | 1511 001 dx | € 198,00 |  Possibilità secondo foro |
| | | | 1511 002 sx | | |
| Accessori: E L4 N2 S T4 Pilette automatiche: PR PQ PC (v. pag. 149) | | | | | |

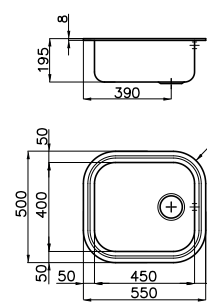
| | | | | | |
|--|--|---|----------|-----------------|---|
| Base 60  | AISI 304 spazzolato dimensioni: 550x500 1 vasca: 450x400 incasso: 530x480 R 135 piletta: 3½" |  | 1611 060 | € 226,00 |  Possibilità secondo foro |
| | | | | | |
| Accessori: E L4 N2 S T4 Pilette automatiche: PR PQ PC (v. pag. 149) | | | | | |

Dotazioni Standard: ganci di fissaggio, guarnizione (no per sottotop), piletta, troppo/pieno e sifone. Imballo in scatola di cartone.



Big Bowl si caratterizza per la capiente vasca 45x40 cm. Una soluzione pratica e versatile.

accessori



E
 Tagliere 45x40
 8655 000
€ 76,00



L4
 Tagliere cristallo
 23x41 cm
 8631 300
€ 96,00



M
 Tagliere scorrevole
 30x54
 8643 000
€ 114,00

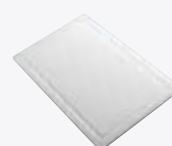

N2
 Tagliere in HDPE
 27,2x42,5 cm
 8657 001
€ 74,00



Q
 Scolapasta bianco
 17x32 cm
 8151 100
€ 32,00



S
 Cestello Inox 40x40
 8612 000
€ 58,00
 Cestello bianco 40x40
 8612 100
€ 37,00

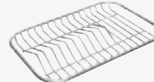

T3
 Griglia portapiatti
 inox 28x40 cm
 8100 280
€ 98,00







T4
 Griglia portapiatti
 inox 25x43 cm
 8100 301
€ 87,00

Uragano



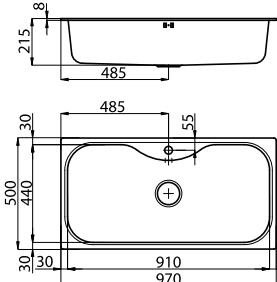

MONOVASCA PER GRANDI PERFORMANCE



miscelatori consigliati

| | Caratteristiche | Versione | Sigla | Prezzo € | Disegno Tecnico |
|--|---|--|-----------------------------------|-----------------|--|
| Base 100  | AISI 304 spazzolato dimensioni: 970x500 1 vasca: 910x440 incasso: 950x480 pileta: 3½" |  STD | 1555 600 | € 554,00 | Le quote perimetrali si riferiscono alla versione d'incasso standard  |
| | |  SF | 1555 609 kit accessori incluso | € 748,00 | |
| | AISI 304 spazzolato dimensioni: 983x513 1 vasca: 910x440 incasso: 950x480 pileta: 3½" | 1054 600 | € 707,00 | | |

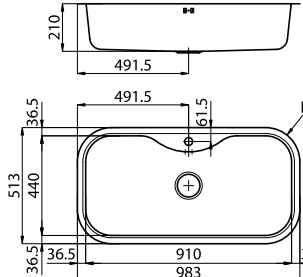
Accessori:
I L2 O Q T U V Z (vedi pag. 106)

| | | | | | |
|--|---|---|----------|-----------------|---|
| Base 100  | AISI 304 spazzolato dimensioni: 983x513 1 vasca: 910x440 incasso FT: vedi sito web incasso FTS: 970x500 R 145 pileta: 3½" |  FT | 1055 600 | € 707,00 |  |
| | |  FTS | 1055 600 | | |
| | | | | | |

Accessori:
I L2 O Q T U V Z (vedi pag. 106)

Dotazioni Standard: ganci di fissaggio, guarnizione (no per sottotop), pileta, troppo/pieno e sifone. Imballo in scatola di cartone.

KIT accessori Uragano



Uragano è proposto anche in versione accessoriata, comprensiva del pratico set descritto a lato.



Tornado

TUTTO QUEL CHE SERVE IN 80 CENTIMETRI

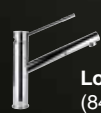





Lorenzo
(8466 000 - pag. 177)

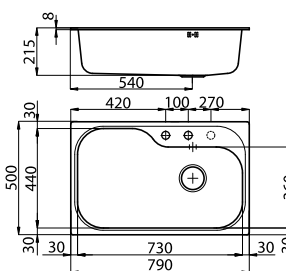

Gamma
(8483 001 - pag. 176)

miscelatori consigliati

| | Caratteristiche | Versione | Sigla | Prezzo € | Disegno Tecnico |
|--|--|--|----------|-----------------|--|
| Base 80  | AISI 304 spazzolato dimensioni: 790x500 1 vasca: 730x440 incasso: 770x480 piletta: automatica 3½" |  STD | 1579 660 | € 498,00 | Le quote perimetrali si riferiscono alla versione d'incasso standard  |
| | AISI 304 spazzolato dimensioni: 803x513 1 vasca: 730x440 incasso: 770x480 piletta: automatica 3½" |  SF | 1078 660 | € 604,00 | |

Accessori:
H I L2 O Q T U Z (vedi pag. 106)



Articolo ad esaurimento

Accessori:
H I L2 O Q T U Z (vedi pag. 106)

Dotazioni Standard: ganci di fissaggio, guarnizione (no per sottotop), piletta, troppo/pieno e sifone. Imballo in scatola di cartone.

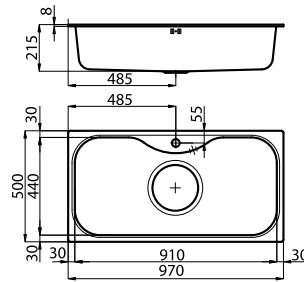

Uragano 7" e Tornado 7"

| | Caratteristiche | Versione | Sigla | Prezzo € | Disegno Tecnico |
|-----------------|---|---|----------|-----------------|---|
| Base 100 | AISI 304 spazzolato dimensioni: 970x500 1 vasca: 910x440 incasso: 950x480 piletta: 7" |  | 1555 070 | € 591,00 |  |

Accessori: **I L2 O Q T U V Z**

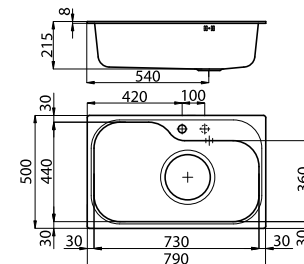
| | | | | | |
|----------------|---|---|----------|-----------------|---|
| Base 80 | AISI 304 spazzolato dimensioni: 790x500 1 vasca: 730x440 incasso: 770x480 piletta: 7" |  | 1579 670 | € 537,00 |  |
|----------------|---|---|----------|-----------------|---|

Accessori: **H I L2 O Q T U Z**

Dotazioni Standard: ganci di fissaggio, guarnizione (no per sottotop), **piletta 7"/sifone, troppo/pieno**. Imballo in scatola di cartone.

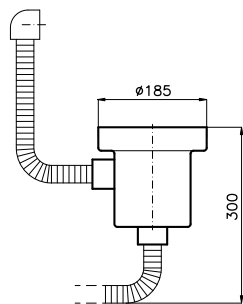

Piletta extralarge

Le grandi vasche di Uragano e Tornado sono particolarmente adatte alla piletta con foro 7", soluzione originale, molto pratica grazie al capiente cestello di raccolta in acciaio inox (cod. 8403 309).



accessori



H
Tagliere
37x30
8659 111
€ 72,00



I
Tagliere
37x46 cm
8659 112
€ 78,00



ad esaurimento

L2
Tagliere Twin
37x46 cm
8644 003
€ 230,00



O **
Vaschetta bianca
36x30 cm
8152 100
€ 44,00



Q
Scolapasta
bianco 17x32 cm
8151 100
€ 32,00



T *
Griglia portapiatti
inox 25x35 cm
8100 154
€ 69,00



U
Griglia portapiatti
inox 25x45 cm
8100 111
€ 83,00



V
Portavaschetta
37x45 cm
8100 112
€ 60,00

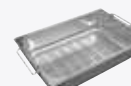

Z *
Scolapasta inox
25x36 cm
8154 000
€ 187,00

*utilizzabile solo in abbinamento al tagliere L2 **per Uragano utilizzabile solo in abbinamento al porta vaschetta V

Angolare NEW

LE SOLUZIONI PER VALORIZZARE GLI ANGOLI



Twix Plus
(8427 020 - pag. 171)



Camillo
(8467 000 - pag. 169)

miscelatori consigliati

LAVELLI

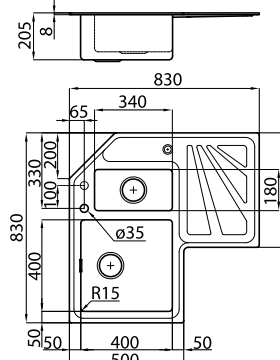
| | Caratteristiche | Versione | Sigla | Prezzo € | Disegno Tecnico |
|--|--|---|----------|----------|---|
| <p>Base 90x90</p>  | <p>AISI 304 spazzolato dimensioni: 830x830 2 vasche: 340x400 incasso: vedi sito web piletta: 3/2"</p> |  | 3303 060 | € 605,00 |  |
| <p>Accessori: A N2 O2 R T4 (v. pag. 108)</p> | | | | | |
| <p>Base 90 (lineare)</p>  | <p>AISI 304 spazzolato dimensioni: 830x830 2v: 400x400+180x340 incasso: vedi sito web piletta: 3/2"+1/4" su gocciolatoio</p> |  | 3308 050 | € 712,00 |  |
| <p>Accessori: L3 L4 N2 N3 O2 L3 P2 P4 S T T1 T2 Z Z2 (v. pag. 108) Pilette automatiche: PA PE PM PL PP PS (vedi pag. 149)</p> | | | | | |

Dotazioni Standard: ganci di fissaggio, guarnizione (no per sottotop), piletta, troppopieno e sifone. Imballo in scatola di cartone.

Circolari NEW

L'ESSENZIALITÀ A TUTTO TONDO





S1000 - Z65
(8449 500 - pag. 187)

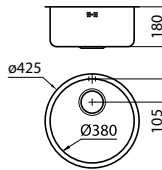

F2000 alto
(8458 000 - pag. 185)

miscelatori consigliati

| | Caratteristiche | Versione | Sigla | Prezzo € | Disegno Tecnico |
|----------------|--|---|----------|-----------------|---|
| Base 45 | AISI 304 spazzolato dimensioni: Ø 425 1 vasca: Ø 380 incasso FT: vedi sito web incasso FTS: Ø 410* piletta: 3½" |  FT | 1130 060 | € 234,00 |  |
| | |  FTS | 1130 060 | | |

* il foro necessita di intaglio per l'alloggio del troppo-pieno (vedi sito web)

Pilette automatiche: **PR PQ PC** (vedi pag. 149)

Dotazioni Standard: ganci di fissaggio, guarnizione (no per sottotop), piletta, troppo/pieno e sifone. Imballo in scatola di cartone.

accessori

| | | | | | | | | |
|---|---|---|--|--|---|--|---|---|
|  A Tagliere 34x40 cm 8647 000 € 92,00 |  L3 Tagliere Twin 41x41 cm 8644 004 € 242,00 |  L4 Tagliere cristallo 23x41 cm 8631 300 € 96,00 |  M Tagliere scorrevole 30x54 8643 000 € 114,00 |  N2 Tagliere in HDPE 27,2x42,5 cm 8657 001 € 74,00 |  N3 Tagliere Twin in HDPE 31,7x42,5 cm 8644 101 € 109,00 |  O2 Vaschetta bianca 27,2x41,4 cm 8153 100 € 39,00 |  P2 Kit grattugie con anello-supporto e vaschetta raccogli vivande - 8159 101 € 146,00 | |
|  P4 Kit tagliere con vaschetta scolapasta in acciaio inox 8644 044 € 278,00 |  R Cestello Inox 34x40 cm 8611 000 € 50,00 |  S Cestello Inox 40x40 8612 000 € 58,00 Cestello bianco 40x40 8612 100 € 37,00 |  T Griglia portapiatti inox 25x35 cm 8100 154 € 69,00 |  T1 Cestello portapiatti 25x42,5 cm 8100 201 € 87,00 |  T2 Cestello portapiatti inox 21,4x37,9 cm 8100 303 € 93,00 |  T4 Griglia portapiatti 25x43 cm 8100 301 € 87,00 |  Z Scolapasta inox 25x36 cm 8154 000 € 187,00 |  Z2 Vaschetta forata inox 21,5x38 cm 8151 000 € 279,00 |

S1000

LA QUALITÀ E LO SPESSORE DELL'ACCIAIO FOSTER

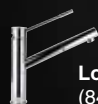









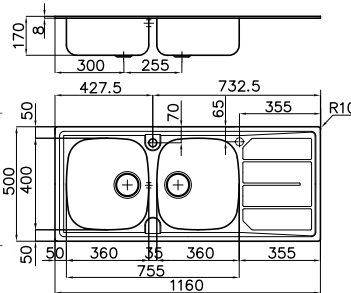

Lorenzo
(8466 000 - pag. 177)



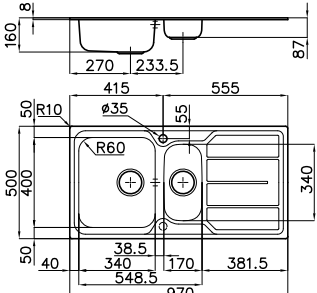



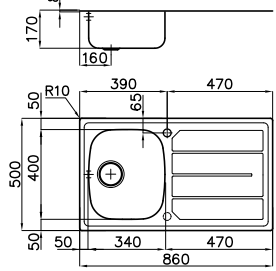



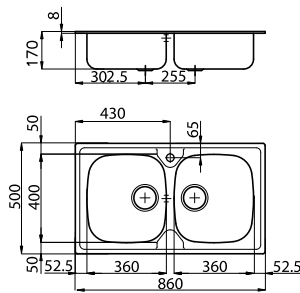

S1000 - RO
(8443 002 - pag. 188)

miscelatori consigliati

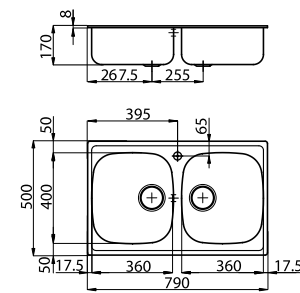
| | Caratteristiche | Versione | Sigla | Prezzo € | Disegno Tecnico |
|--|---|--|-------------|-----------------|---|
| Base 80/(90)^T (rif. pag. 55)  <p><i>In foto versione sinistra</i></p> | AISI 304 spazzolato dimensioni: 1160x500 2 vasche: 360x400 incasso: 1140x480 piletta: 3½" |  | 1812 161 dx | € 184,00 |  |
| | | | 1812 162 sx | | |
| Accessori: M N2 R T4 (vedi pag. 108) Pilette automatiche: PR PQ PC (vedi pag. 149) | AISI 304 microfooster dimensioni: 1160x500 2 vasche: 360x400 incasso: 1140x480 piletta: 3½" |   | 1812 461 dx | € 187,00 | Possibilità secondo foro |
| | | | 1812 462 sx | | |
| Base 60/(80)^T (rif. pag. 55)  <p><i>In foto versione sinistra</i></p> | AISI 304 spazzolato dimensioni: 970x500 2v: 340x400+170x340 incasso: 950x480 piletta: 3½" |  | 1197 161 dx | € 187,00 |  |
| | | | 1197 162 sx | | |
| Accessori: M N2 R T4 (vedi pag. 108) Pilette automatiche: PR PQ PC (vedi pag. 149) | AISI 304 microfooster dimensioni: 970x500 2v: 340x400+170x340 incasso: 950x480 piletta: 3½" |   | 1197 461 dx | € 190,00 | Possibilità secondo foro |
| | | | 1197 462 sx | | |
| Base 45  <p><i>In foto versione sinistra</i></p> | AISI 304 spazzolato dimensioni: 860x500 1 vasca: 340x400 incasso: 840x480 piletta: 3½" |  | 1186 161 dx | € 137,00 |  |
| | | | 1186 162 sx | | |
| Accessori: M N2 R T4 (vedi pag. 108) Pilette automatiche: PR PQ PC (vedi pag. 149) | | | | | Possibilità secondo foro |
| | | | | | |

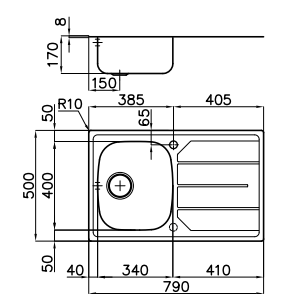
Dotazioni Standard: ganci di fissaggio, guarnizione (no per sottotop), piletta, tropp/pieno e sifone. Imballo in scatola di cartone.

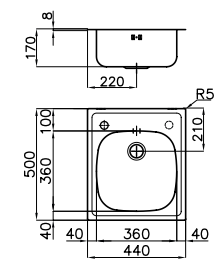
S1000

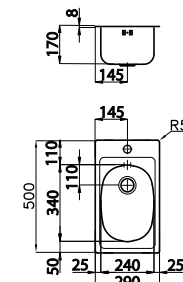
| | Caratteristiche | Versione | Sigla | Prezzo € | Disegno Tecnico |
|---|---|---|----------------------------|----------|---|
| <p>Base 80/(90)^T (rif. pag. 55)</p>  | <p>AISI 304 spazzolato dimensioni: 860x500 2 vasche: 360x400 incasso: 840x480 piletta: 3½"</p> |  | 1886 160 | € 165,00 |  |
| <p>Accessori: M N2 R T4 (vedi pag. 108)</p> | | | | | |
| <p>Base 80</p>  | <p>AISI 304 spazzolato dimensioni: 790x500 2 vasche: 360x400 incasso: 770x480 piletta: 3½"</p> |  | 1279 060 | € 165,00 |  |
| <p>Accessori: M N2 R T4 (vedi pag. 108)</p> | | | | | |
| <p>Base 45</p>  | <p>AISI 304 spazzolato dimensioni: 790x500 1 vasca: 340x400 incasso: 770x480 piletta: 3½"</p> |  | 1179 061 dx 1179 062 sx | € 137,00 |  |
| <p><i>In foto versione sinistra</i></p> | | | | | |
| <p>Accessori: M N2 R T4 (vedi pag. 108) Pilette automatiche: PR PQ PC (vedi pag. 149)</p> | | | | | |
| Possibilità secondo foro | | | | | |
| <p>Base 45</p>  | <p>AISI 304 spazzolato dimensioni: 440x500 1 vasca: 360x360 incasso: 420x480 piletta: 2"</p> |  | 1144 001 dx 1144 002 sx | € 149,00 |  |
| <p><i>In foto versione sinistra</i></p> | | | | | |
| <p>Per versione dx si intende foro miscelatore a destra; le versioni sx hanno foro a sinistra</p> | | | | | |
| Possibilità secondo foro | | | | | |
| <p>Base 30</p>  | <p>AISI 304 spazzolato dimensioni: 290x500 1 vasca: 240x340 incasso: 270x480 piletta: 2"</p> |  | 1129 000 | € 136,00 |  |

Monovasca S1000

LA PRATICITÀ DI UNA GRANDE VASCA



T/P perimetrale



Luisa
(8482 000 - pag. 177)



S1000 - Z65
(8449 500 - pag. 187)

miscelatori consigliati

| | Caratteristiche | Versione | Sigla | Prezzo € | Disegno Tecnico |
|--|-----------------|----------|-------|----------|-----------------|
|--|-----------------|----------|-------|----------|-----------------|

Base 80



AISI 304 spazzolato
dimensioni: **865x505**
1 vasca: **726x350**
incasso: 840x480
piletta: 3/2"



1180 150

€ 162,00

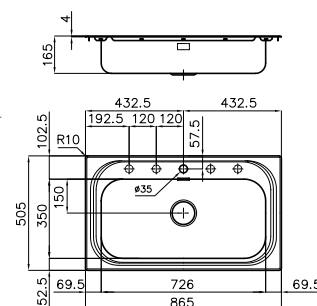

Accessori: **L5** **M** **B6** **T6**
Pilette automatiche: **PA** **PE** **PM** **PL** **PP** **PS**
(v. pag. 148-149)

Possibilità secondo e terzo foro

Dotazioni Standard: ganci di fissaggio, guarnizione (no per sottotop), piletta, troppo/pieno e sifone. Imballo in scatola di cartone.

accessori

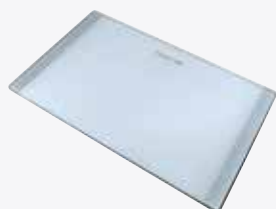

L5
Tagliere cristallo
29x54 cm
8633 300
€ 110,00



M
Tagliere scorrevole
30x54 cm
8643 000
€ 114,00



B6
Tagliere
26x36,6 cm
8643 117
€ 71,00

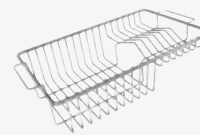

T6
Cestello
portapiatti inox
23x37 cm
8100 305
€ 83,00

LAVELLI



LAVELLI SOTTOTOP

Foster
Milano
p. 114



Milanello
workstation
p. 116



Triplo Invaso
Workstation
p. 119



GK p. 120



Quadra
p. 122



S4001
p. 124



Serie 45
p. 126



Serie 35
p. 127



KE-R15
p. 128



KE
Gun Metal
p. 132



KE Gold
p. 134



KE Copper
p. 135



S400
p. 136



KS p. 137



Big Bowl
p. 138



Circolari
p. 138



Elettra
p. 139



Tornado
p. 139









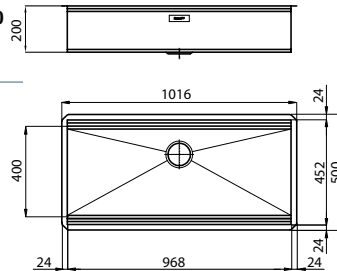

Foster Milano

UN CONCETTO INNOVATIVO DI FUNZIONALITÀ



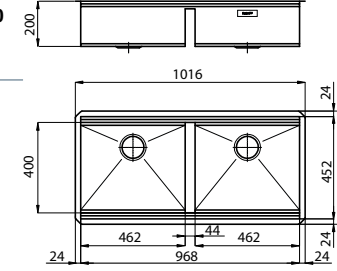
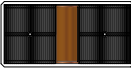



miscelatori consigliati

| | Caratteristiche | Versione | Sigla | Prezzo € | Disegno Tecnico |
|---|---|---|-----------------|-------------------|--|
| Base 120  Accessori opzionali: (vedi pag. 115) M6 P3 L4 N3 O2 P2 T2 Z2 PS Pilette automatiche: PA PE PM PL PP PS (v. pag. 148-149) | AISI 304 satinato vasca: 968x400 dimensioni: 1016x500 incasso: 968x452 piletta: SPACE 3½" |  | 1015 850 | € 909,00 |  |
| |  Configurazione griglie Black a filo vasca | | | |  Configurazione griglie Black su fondo vasca |
| Base 120  Accessori opzionali: (vedi pag. 115) M6 P3 L4 N3 O2 P2 T2 Z2 PS Pilette automatiche: PA PE PM PL PP PS (v. pag. 148-149) | AISI 304 satinato 2 vasche: 462x400 dimensioni: 1016x500 incasso: 968x452 piletta: SPACE 3½" |  | 1016 850 | € 1.189,00 |  |
| |  Configurazione griglie Black a filo vasca | | | |  Configurazione griglie Black su fondo vasca |

Dotazioni Standard: ganci di fissaggio, guarnizione (no per sottotop), piletta, tropp/pieno e sifone. Imballo in scatola di cartone.

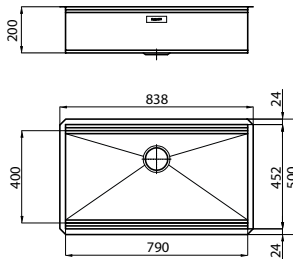
Foster Milano

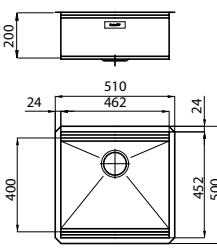
| | Caratteristiche | Versione | Sigla | Prezzo € | Disegno Tecnico |
|--|---|--|----------|----------|---|
| Base 90  | AISI 304 satinato vasca: 790x400 dimensioni: 838x500 incasso: 790x452 piletta: SPACE 3½" |  ST | 1014 850 | € 800,00 |  |
| | | | | | |
| Base 60  | AISI 304 satinato vasca: 462x400 dimensioni: 510x500 incasso: 462x452 piletta: SPACE 3½" |  ST | 1013 850 | € 708,00 |  |
| | | | | | |

Dotazioni Standard: ganci di fissaggio, guarnizione (no per sottotop), piletta, troppo/pieno e sifone. Imballo in scatola di cartone.



Sistema a tre invasi
 Foster Milano ha un ingegnoso design, con un sistema di tre invasi dove gli accessori alloggiati su livelli distinti. Sul primo, scorrono le innovative griglie Black, una grande e pratica superficie per risciacquare, scolare, lavorare.



Gamma completa di accessori
 Il secondo invaso è studiato per far scorrere una combinazione completa di accessori che rendono sicura e pratica ogni operazione: risciacquare, scolare, affettare, grattugiare... sempre all'interno del lavello.



Griglia di protezione sul fondo
 Il terzo invaso è sul fondo della vasca quadra. Su questo trovano alloggio le griglie Black per risciacquare i cibi senza che vengano a contatto con il fondo eventualmente sporco, o per appoggiare pentole senza graffiare la superficie.

Accessori

| | | | |
|--|--|--|---|
|  <p>L4 Tagliere cristallo 23x41 cm 8631 300 € 96,00</p> |  <p>M6 Tagliere legno noce 18x44,8 cm 8642 000 € 85,00</p> |  <p>N3 Tagliere Twin in HDPE 31,7x42,5 8644 101 € 109,00</p> |  <p>O2 Vaschetta bianca 27,2x41,4 cm 8153 100 € 39,00</p> |
|  <p>P2 * Kit grattugie con anello-supporto e vaschetta vivande 8159 101 € 146,00</p> |  <p>P3 Griglia Black 39,2x44,8 cm 8100 600 € 262,00</p> |  <p>T2 * Cestello portapiatti inox 21,4x37,9 cm 8100 303 € 93,00</p> |  <p>Z2 * Vaschetta forata inox 21,5x38 cm 8151 000 € 279,00</p> |

*utilizzabile solo in abbinamento al tagliere N3

LAVELLI SOTTOTOP

Milanello workstation



Piletta SPACE



T/P perimetrale



Piletta Salva spazio



Milanello workstation







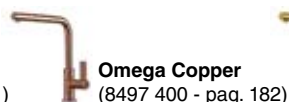

| | Caratteristiche | Versione | Sigla | Prezzo € | Disegno Tecnico |
|---|---|---|---|------------|---|
|  | AISI 304 satinato vasca: 750x374 dimensioni: 790x466 incasso: v. sito web piletta: SPACE 3½" |  | 1034 850 | € 1.170,00 |  |
| | In dotazione: 2 griglie Black Milanello (8100 602) Accessori opzionali: (vedi pag. 118) Z3 T8 L3 L4 M7 N3 N2 P2 T T2 Z Z2 Pilette automatiche: PP (vedi pag. 148) |  Configurazione griglie Black a filo vasca |  Configurazione griglie Black su fondo vasca | | |
|  | AISI 304 Gun Metal vasca: 750x374 dimensioni: 790x466 incasso: v. sito web piletta: 3½" Gun Metal |  | 1034 856 | € 2.304,00 |  |
| | In dotazione: 2 griglie Black Milanello (8100 602) Accessori opzionali: (vedi pag. 118) Z3 T8 L3 L4 M7 N3 N2 P2 T T2 Z Z2 Pilette automatiche: PO (vedi pag. 148) |  Configurazione griglie Black a filo vasca |  Configurazione griglie Black su fondo vasca | | |
|  | AISI 304 Gold vasca: 750x374 dimensioni: 790x466 incasso: v. sito web piletta: 3½" Gold |  | 1034 859 | € 2.304,00 |  |
| | In dotazione: 2 griglie Black Milanello (8100 602) Accessori opzionali: (vedi pag. 118) Z3 T8 L3 L4 M7 N3 N2 P2 T T2 Z Z2 Pilette automatiche: PD (vedi pag. 148) |  Configurazione griglie Black a filo vasca |  Configurazione griglie Black su fondo vasca | | |
|  | AISI 304 Copper vasca: 750x374 dimensioni: 790x466 incasso: v. sito web piletta: 3½" Copper |  | 1034 858 | € 2.304,00 |  |
| | In dotazione: 2 griglie Black Milanello (8100 602) Accessori opzionali: (vedi pag. 118) Z3 T8 L3 L4 M7 N3 N2 P2 T T2 Z Z2 Pilette automatiche: PB (vedi pag. 148) |  Configurazione griglie Black a filo vasca |  Configurazione griglie Black su fondo vasca | | |

Dotazioni Standard: ganci di fissaggio, guarnizione (no per sottotop), piletta, troppo/pieno e sifone. Imballo in scatola di cartone.

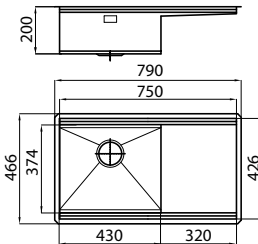
miscelatori consigliati

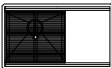

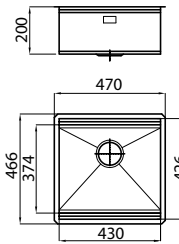
Milanello workstation

| | Caratteristiche | Versione | Sigla | Prezzo € | Disegno Tecnico |
|---|---|--|----------------------------|-------------------|---|
| Base 90  | AISI 304 satinato vasca: 430x374 dimensioni: 790x466 incasso: v. sito web piletta: SPACE 3½" |  | 1040 851 dx 1040 852 sx | € 1.412,00 |  |
| In dotazione: 2 griglie Black Milanello (8100 602) | | | | | |
| Accessori opzionali: Z3 T8 L3 L4 M7 N3 N2 P2 T T2 Z Z2 | | | | | |
| Pilette automatiche: PP (vedi pag. 148) | | | | | |
|  Configurazione griglie Black a filo vasca | |  Configurazione griglie Black su fondo vasca | | | |
| Base 60  | AISI 304 satinato vasca: 430x374 dimensioni: 470x466 incasso: v. sito web piletta: SPACE 3½" |  | 1031 850 | € 953,00 |  |
| In dotazione: 1 griglia Black Milanello (8100 602) | | | | | |
| Accessori opzionali: Z3 T8 L3 L4 M7 N3 N2 P2 T T2 Z Z2 | | | | | |
| Pilette automatiche: PP (vedi pag. 148) | | | | | |
|  Configurazione griglie Black a filo vasca | |  Configurazione griglie Black su fondo vasca | | | |



Griglie Black in dotazione a copertura completa della vasca (cod. 8100 602).

Accessori

accessori opzionali scorrevoli sotto le griglie



Z3
 Vaschetta forata
 inox 21,5x40 cm
 8156 000
€ 274,00



T8
 Griglia portapiatti
 inox 21,4x37,2 cm
 8100 306
€ 80,00

altri accessori opzionali



L3
 Tagliere Twin
 41x41 cm
 8644 004
€ 242,00



L4
 Tagliere cristallo
 23x41 cm
 8631 300
€ 96,00



M7
 Tagliere legno noce
 15,8x42,4 cm
 8642 003
€ 83,00



N2
 Tagliere in HDPE
 27,2x42,5 cm
 8657 001
€ 74,00



N3
 Tagliere Twin
 in HDPE 31,7x42,5
 8644 101
€ 109,00



P2 **
 Kit grattugie con
 anello-supporto e
 vaschetta vivande
 8159 101
€ 146,00



T *
 Griglia portapiatti
 inox 25x35 cm
 8100 154
€ 69,00



T2 **
 Cestello portapiatti
 inox 21,4x37,9 cm
 8100 303
€ 93,00

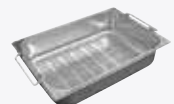

Z *
 Scolapasta inox
 25x36 cm
 8154 000
€ 187,00



Z2 **
 Vaschetta forata
 inox 21,5x38 cm
 8151 000
€ 279,00

*utilizzabile solo in abbinamento al tagliere L3 **utilizzabile solo in abbinamento al tagliere N3

Triplo Invaso Workstation **NEW**



MISCELATORE IN DOTAZIONE



Eclipse
(8499 000 - pag. 174)



Piletta SPACE



T/P perimetrale



Piletta Salva spazio

LAVELLI
SOTTOTOP

| | Caratteristiche | Versione | Sigla | Prezzo € | Disegno Tecnico |
|----------------|---|-----------|----------|-------------------|-----------------|
| Base 90 | AISI 304 spazzolato 1 vasca: 710x400 dimensioni: 835x515 incasso: v. sito web* piletta: automatica SPACE 3½" PP | ST | 1491 059 | € 1.959,00 | |
| | IN DOTAZIONE: | | | | |
| | miscelatore Eclipse (cod. 8499 000) | | | | |
| | 2 griglie black TI (cod. 8100 603) | | | | |
| Accessori: | L4 M2 N2 O2 S U2 | | | | |

Dotazioni Standard: ganci di fissaggio, guarnizione (no per sottotop), piletta, troppo/pieno e sifone. Imballo in scatola di cartone.

il lavello Triplo invaso sparisce nel piano di lavoro, grazie al miscelatore abbattibile Eclipse, e alle griglie Black, che chiudono interamente la vasca.



accessori

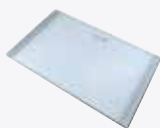

L4
Tagliere cristallo
23x41 cm
8631 300
€ 96,00



M2
Tagliere 28x48
8643 115
€ 66,00



N2
Tagliere in HDPE
27,2x42,5 cm
8657 001
€ 74,00



O2
Vaschetta bianca
27,2x41,4 cm
8153 100
€ 39,00



S
Cestello Inox 40x40
8612 000
€ 58,00

Cestello bianco 40x40
8612 100
€ 37,00







U2
Griglia portapiatti
inox 23x47
8100 115
€ 78,00

GK

UN DESIGN ESSENZIALE MA RICERCATO



miscelatori consigliati

| | Caratteristiche | Versione | Sigla | Prezzo € | Disegno Tecnico |
|--|--|---|-----------------|-----------------|-----------------|
| <p>Base 90</p>  <p>Accessori: M4 N4 T2 P2 Z2 Pilette autom.: PA PE PM PL PP PS (v. pag. 148-149)</p> | <p>AISI 304 satinato vasca: 73x40 cm dimensioni: 860x470 incasso: vedi sito web piletta: SPACE 3½"</p> |  | <p>1401 800</p> | <p>€ 819,00</p> | |
| <p>Base 60</p>  <p>Accessori: M4 N4 T2 P2 Z2 Pilette autom.: PA PE PM PL PP PS (v. pag. 148-149)</p> | <p>AISI 304 satinato vasca: 45x40 cm dimensioni: 580x470 incasso: vedi sito web piletta: SPACE 3½"</p> |  | <p>1403 800</p> | <p>€ 718,00</p> | |

Dotazioni Standard: ganci di fissaggio, guarnizione (no per sottotop), piletta, troppo/pieno e sifone. Imballo in scatola di cartone.

| Caratteristiche | Versione | Sigla | Prezzo € | Disegno Tecnico |
|-----------------|----------|-------|----------|-----------------|
|-----------------|----------|-------|----------|-----------------|

Base 60



AISI 304 satinato
vasca: **37x40 cm**
dimensioni: 480x450
incasso: vedi sito web
piletta: **SPACE 3½"**



1405 800

€ 607,00

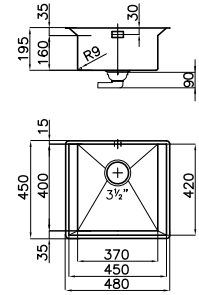

Accessori: **M4** **N4**

T2 **P2** **Z2** solo in abbinamento al tagliere **N4**

Pilette autom.: **PA** **PE** **PM** **PL** **PP** **PS**

(v. pag. 148-149)

Dotazioni Standard: ganci di fissaggio, guarnizione (no per sottotop), piletta, troppo/pieno e sifone. Imballo in scatola di cartone.

LAVELLI
SOTTOTOP

accessori



M4
Tagliere scorrevole
Iroko
8656 001
€ 110,00



N4
Tagliere Twin
in HDPE
8644 100
€ 121,00

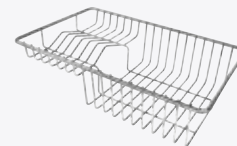

T2
Cestello portapiatti
inox 25x42,5 cm
8100 303
€ 93,00



P2
Kit grattugie con anello-
supporto e vaschetta
8159 101
€ 146,00











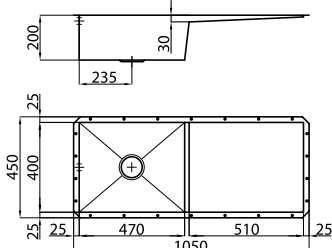

Z2
Vaschetta forata inox
8151 000
€ 279,00

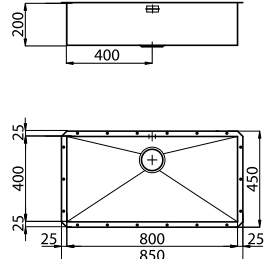

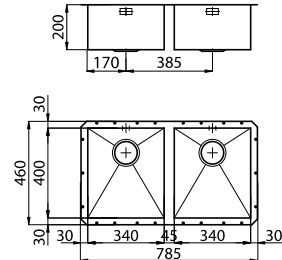

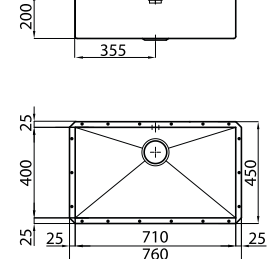

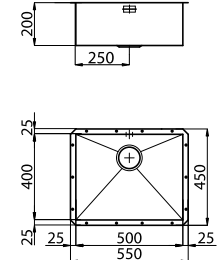

PA
Piletta automatica
8407 108
€ 96,00

Quadra

| | Caratteristiche | Versione | Sigla | Prezzo € | Disegno Tecnico |
|--|--|---|----------|------------|---|
| <p>Base 120</p>  | <p>AISI 304 satinato vasca: 47x40 cm dimensioni: 1050x450 incasso: vedi sito web piletta: 3½" T/P perimetrale</p> |  | 1210 850 | € 978,00 |  |
| <p>Accessori: L3 L4 N2 N3 O2 P2 P4 S T T1 T2 Z Z2</p> <p>Pilette autom.: PA PE PM PL PP PS (v. pag. 148-149)</p> | | | | | |
| <p>Base 90</p>  | <p>AISI 304 satinato vasca: 80x40 cm dimensioni: 850x450 incasso: vedi sito web piletta: 3½" T/P perimetrale</p> |  | 1218 850 | € 473,00 |  |
| <p>Accessori: L3 L4 N2 N3 O2 P2 P4 S T T1 T2 Z Z2</p> <p>Pilette autom.: PA PE PM PL PP PS (v. pag. 148-149)</p> | | | | | |
| <p>Base 80</p>  | <p>AISI 304 satinato vasca: (2x) 34x40 cm dimensioni: 785x460 incasso: vedi sito web piletta: 3½" T/P perimetrale</p> |  | 1208 850 | € 1.069,00 |  |
| <p>Accessori: L4 N2 N3 O2 P2 P4 R T1 T2 Z2</p> <p>Pilette autom.: PA PE PM PL PP PS (v. pag. 148-149)</p> | | | | | |
| <p>Base 80</p>  | <p>AISI 304 satinato vasca: 71x40 cm dimensioni: 760x450 incasso: vedi sito web piletta: 3½" T/P perimetrale</p> |  | 1217 850 | € 467,00 |  |
| <p>Accessori: L3 L4 N2 N3 O2 P2 P4 S T T1 T2 Z Z2</p> <p>Pilette autom.: PA PE PM PL PP PS (v. pag. 148-149)</p> | | | | | |
| <p>Base 60</p>  | <p>AISI 304 satinato vasca: 50x40 cm dimensioni: 550x450 incasso: vedi sito web piletta: 3½" T/P perimetrale</p> |  | 1215 850 | € 452,00 |  |
| <p>Accessori: L3 L4 N2 N3 O2 P2 P4 S T T1 T2 Z Z2</p> <p>Pilette autom.: PA PE PM PL PP PS (v. pag. 148-149)</p> | | | | | |

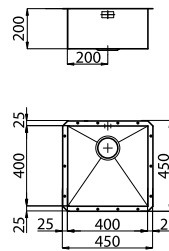

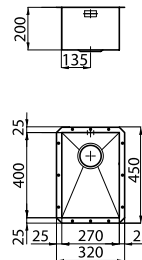

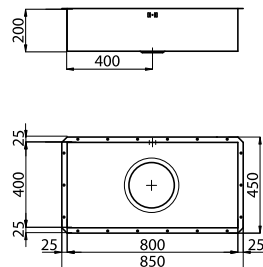

Dotazioni Standard: ganci di fissaggio, guarnizione (no per sottotop), piletta, troppo/pieno e sifone. Imballo in scatola di cartone.

Quadra

| | Caratteristiche | Versione | Sigla | Prezzo € | Disegno Tecnico |
|--|---|--|----------|----------|---|
| Base 45  | AISI 304 satinato vasca: 40x40 cm dimensioni: 450x450 incasso: vedi sito web piletta: 3½" T/P perimetrale |  | 1214 850 | € 432,00 |  |
| Accessori: L3 L4 N2 N3 O2 P2 P4 S T T1 T2 Z Z2 Pilette autom.: PA PE PM PL PP PS (v. pag. 148-149) | | | | | |
| Base 40  | AISI 304 satinato vasca: 27x40 cm dimensioni: 320x450 incasso: vedi sito web piletta: 3½" T/P perimetrale |  | 1202 850 | € 404,00 |  |
| Accessori: L4 N2 O2 T1 Pilette autom.: PA PE PM PL PP PS (v. pag. 148-149) | | | | | |
| Quadra 7" Base 90  | AISI 304 satinato vasca: 80x40 cm dimensioni: 850x450 incasso: vedi sito web piletta: 7" |  | 1218 897 | € 610,00 |  |
| Accessori: L3 L4 N2 O2 S T T1 Z | | | | | |

Dotazioni Standard: ganci di fissaggio, guarnizione (no per sottotop), piletta, troppo/pieno e sifone. Imballo in scatola di cartone.

accessori

| | | | | | |
|--|---|---|---|---|--|
|  <p>L3 Tagliere Twin 41x41 cm 8644 004 € 242,00</p> |  <p>L4 Tagliere cristallo 23x41 cm 8631 300 € 96,00</p> |  <p>N2 Tagliere in HDPE 27,2x42,5 cm 8657 001 € 74,00</p> |  <p>N3 Tagliere Twin in HDPE 31,7x42,5 cm 8644 101 € 109,00</p> |  <p>O2 Vaschetta bianca 27,2x41,4 cm 8153 100 € 39,00</p> |  <p>P2 ** Kit grattugie con anello-supporto e vaschetta raccogli vivande - 8159 101 € 146,00</p> |
|  <p>P4 Kit tagliere con vaschetta scolapasta in acciaio inox 8644 044 € 278,00</p> |  <p>R Cestello Inox 34x40 cm 8611 000 € 50,00</p> |  <p>S Cestello Inox 40x40 8612 000 € 58,00 Cestello bianco 40x40 8612 100 € 37,00</p> |  <p>T * Griglia portapiatti inox 25x35 cm 8100 154 € 69,00</p> |  <p>Z * Scolapasta inox 25x36 cm 8154 000 € 187,00</p> |  <p>Z2 ** Vaschetta forata inox 21,5x38 cm 8151 000 € 279,00</p> |
|  <p>T1 Cestello portapiatti inox 25x42,5 cm 8100 201 € 87,00</p> |  <p>T2 ** Cestello portapiatti inox 21,4x37,9 cm 8100 303 € 93,00</p> | | | | |

*utilizzabile solo in abbinamento al tagliere L3 **utilizzabile solo in abbinamento al tagliere N3

S4001 - vasche sottotop

QUALITÀ ESSENZIALE



Piletta SPACE



T/P perimetrale



Piletta Salva spazio









Tre Alto
(8468 000 - pag. 172)

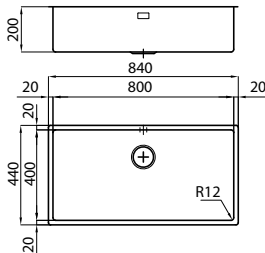

1/2 Circle
(8480 000 - pag. 170)

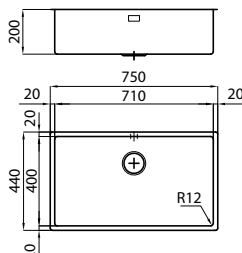
miscelatori consigliati

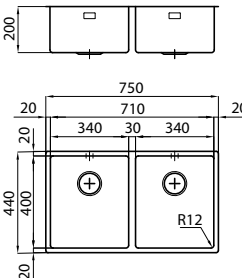





| | Caratteristiche | Versione | Sigla | Prezzo € | Disegno Tecnico |
|---|---|---|----------|----------|---|
| <p>Base 90</p>  <p>Accessori: L3 L4 N2 N3 O2 P2 P4 S T T1 T2 Z Z2 Piletta automatica: PA PE PM PL PP PS (v. pag. 148-149)</p> | <p>AISI 304 satinato 1 vasca: 800x400 dimensioni: 840x440 incasso: 800x400 piletta: SPACE 3½"</p> |  | 3358 850 | € 615,00 |  |
| <p>Base 80</p>  <p>Accessori: L3 L4 N2 N3 O2 P2 P4 S T T1 T2 Z Z2 Piletta automatica: PA PE PM PL PP PS (v. pag. 148-149)</p> | <p>AISI 304 satinato 1 vasca: 710x400 dimensioni: 750x440 incasso: 710x400 piletta: SPACE 3½"</p> |  | 3357 850 | € 565,00 |  |
| <p>Base 80</p>  <p>Accessori: L4 N2 N3 O2 P2 P4 R T1 T2 Z2 Piletta automatica: PA PE PM PL PP PS (v. pag. 148-149)</p> | <p>AISI 304 satinato 2 vasche: 340x400 dimensioni: 750x440 incasso: 710x400 piletta: SPACE 3½"</p> |  | 3352 850 | € 807,00 |  |

Dotazioni Standard: ganci di fissaggio, piletta, troppo/pieno e sifone. Imballo in scatola di cartone.

S4001 - vasche sottotop

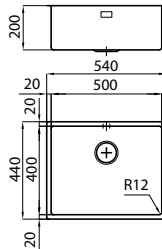
NEW

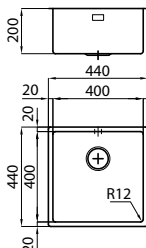
Foster 

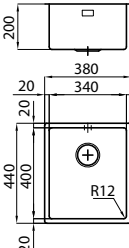
| | Caratteristiche | Versione | Sigla | Prezzo € | Disegno Tecnico |
|--|---|---|----------|----------|---|
| Base 60  | AISI 304 satinato 1 vasca: 500x400 dimensioni: 540x440 incasso: 500x400 piletta: SPACE 3½" |  | 3355 850 | € 476,00 |  |
| Accessori: L3 L4 N2 N3 O2 P2 P4 S T T1 T2 Z Z2 Piletta automatica: PA PE PM PL PP PS (v. pag. 148-149) | | | | | |
| Base 60  | AISI 304 satinato 1 vasca: 400x400 dimensioni: 440x440 incasso: 400x400 piletta: SPACE 3½" |  | 3356 850 | € 374,00 |  |
| Accessori: L3 L4 N2 N3 O2 P2 P4 S T T1 T2 Z Z2 Piletta automatica: PA PE PM PL PP PS (v. pag. 148-149) | | | | | |
| Base 45  | AISI 304 satinato 1 vasca: 340x400 dimensioni: 380x440 incasso: 340x400 piletta: SPACE 3½" |  | 3353 850 | € 363,00 |  |
| Accessori: L4 N2 N3 O2 P2 P4 R T1 T2 Z2 Piletta automatica: PA PE PM PL PP PS (v. pag. 148-149) | | | | | |

Dotazioni Standard: ganci di fissaggio, piletta, troppo/pieno e sifone. Imballo in scatola di cartone.

accessori

| | | | | | |
|--|--|---|---|--|--|
|  <p>L3 Tagliere Twin 41x41 cm 8644 004 € 242,00</p> |  <p>L4 Tagliere cristallo 23x41 cm 8631 300 € 96,00</p> |  <p>N2 Tagliere in HDPE 27,2x42,5 cm 8657 001 € 74,00</p> |  <p>N3 Tagliere Twin in HDPE 31,7x42,5 cm 8644 101 € 109,00</p> |  <p>O2 Vaschetta bianca 27,2x41,4 cm 8153 100 € 39,00</p> |  <p>P2 ** Kit grattugie con anello-supporto e vaschetta raccogli vivande - 8159 101 € 146,00</p> |
|  <p>P4 Kit tagliere con vaschetta scolapasta in acciaio inox 8644 044 € 278,00</p> |  <p>R Cestello Inox 34x40 cm 8611 000 € 50,00</p> |  <p>S Cestello Inox 40x40 8612 000 € 58,00 Cestello bianco 40x40 8612 100 € 37,00</p> |  <p>T * Griglia portapiatti inox 25x35 cm 8100 154 € 69,00</p> |  <p>T1 Cestello portapiatti inox 25x42,5 cm 8100 201 € 87,00</p> |  <p>T2 ** Cestello portapiatti inox 21,4x37,9 cm 8100 303 € 93,00</p> |
|  <p>Z * Scolapasta inox 25x36 cm 8154 000 € 187,00</p> |  <p>Z2 ** Vaschetta forata inox 21,5x38 cm 8151 000 € 279,00</p> | | | | |



*utilizzabile solo in abbinamento al tagliere L3 **utilizzabile solo in abbinamento al tagliere N3

LAVELLI
SOTTOTOP



Serie 45

NEW

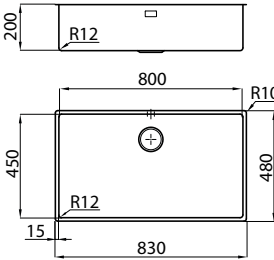

VASCHE OVERSIZE

| | Caratteristiche | Versione | Sigla | Prezzo € | Disegno Tecnico |
|---|---|---|----------|----------|---|
| Base 90  | AISI 304 spazzolato vasca: 80x45 cm dimensioni: 830x480 incasso: vedi sito web piletta: 3½" T/P perimetrale |  | 3143 850 | € 652,00 |  |

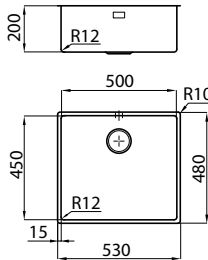
Accessori:
N5 O2 P2 S T2 Z Z2

| | | | | | |
|---|---|---|----------|----------|---|
| Base 60  | AISI 304 spazzolato vasca: 50x45 cm dimensioni: 530x480 incasso: vedi sito web piletta: 3½" T/P perimetrale |  | 3141 850 | € 455,00 |  |
|---|---|---|----------|----------|---|

Accessori:
N5 O2 P2 S T2 Z Z2

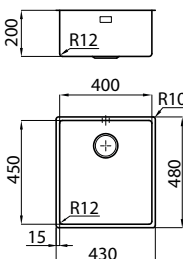
| | | | | | |
|---|---|---|----------|----------|---|
| Base 45  | AISI 304 spazzolato vasca: 40x45 cm dimensioni: 430x480 incasso: vedi sito web piletta: 3½" T/P perimetrale |  | 3139 850 | € 403,00 |  |
|---|---|---|----------|----------|---|

Accessori:
N5 O2 P2 S T2 Z Z2

Dotazioni Standard: ganci di fissaggio, guarnizione (no per sottotop), piletta, troppo/pieno e sifone. Imballo in scatola di cartone.



T/P perimetrale

accessori

N5
 Kit cornice supporto
 28x47,4
 multiaccessori con
 tagliere HDPE
 8100 627
 € 282,00

O2
 Vaschetta bianca
 27,2x41,4 cm
 8153 100
 € 39,00

P2 *
 Kit grattugie con
 anello-supporto e
 vaschetta raccogli
 vivande - 8159 101
 € 146,00

S
 Cestello Inox 40x40
 8612 000
 € 58,00
 Cestello bianco 40x40
 8612 100
 € 37,00

T2 *
 Cestello portapiatti
 inox 21,4x37,9 cm
 8100 303
 € 93,00

Z
 Scolapasta inox
 25x36 cm
 8154 000
 € 187,00







Z2 *
 Vaschetta forata
 inox 21,5x38 cm
 8151 000
 € 279,00

*utilizzabile solo in abbinamento al kit N5

Serie 35

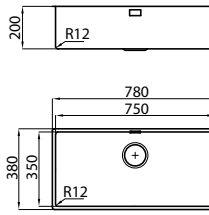
NEW

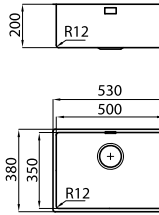
PIÙ SPAZIO SUL TOP

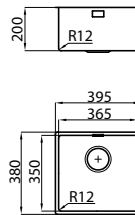
| | Caratteristiche | Versione | Sigla | Prezzo € | Disegno Tecnico |
|---|---|---|----------|----------|---|
| <p>Base 80</p>  <p>35 cm</p> | <p>AISI 304 spazzolato vasca: 75x35 cm dimensioni: 780x380 incasso: vedi sito web piletta: 3½" T/P perimetrale</p> |  | 3137 850 | € 458,00 |  |
| <p>Accessori: B6 T6 O2</p> <p>Pilette autom.: PA PE PM PL PP PS (v. pag. 148-149)</p> | | | | | |
| <p>Base 60</p>  <p>35 cm</p> | <p>AISI 304 spazzolato vasca: 50x35 cm dimensioni: 530x380 incasso: vedi sito web piletta: 3½" T/P perimetrale</p> |  | 3135 850 | € 329,00 |  |
| <p>Accessori: B6 T6 O2</p> <p>Pilette autom.: PA PE PM PL PP PS (v. pag. 148-149)</p> | | | | | |
| <p>Base 45</p>  <p>35 cm</p> | <p>AISI 304 spazzolato vasca: 36,5x35 cm dimensioni: 395x380 incasso: vedi sito web piletta: 3½" T/P perimetrale</p> |  | 3136 850 | € 275,00 |  |
| <p>Accessori: B6 T6</p> <p>Pilette autom.: PA PE PM PL PP PS (v. pag. 148-149)</p> | | | | | |

Dotazioni Standard: ganci di fissaggio, guarnizione (no per sottotop), piletta, troppolieno e sifone. Imballo in scatola di cartone.



T/P perimetrale

La profondità delle vasche Serie 35 si abbina perfettamente a quella dei piani induzione S4000 con zone di cottura in linea (v. pag. 198-200)



accessori



B6
Tagliere
26x36,6 cm
8643 117
€ 71,00



T6
Griglia portapiatti
inox 23x37,5
8100 305
€ 83,00



O2
Vaschetta bianca
27,2x41,4 cm
8153 100
€ 39,00

LAVELLI
SOTTOTOP

KE - R15

IL MODELLO GIUSTO PER OGNI ESIGENZA



T/P perimetrale







Camillo
(8467 000 - pag. 169)



Lorenzo
(8466 000 - pag. 177)



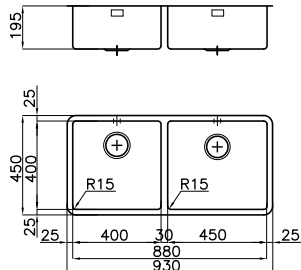

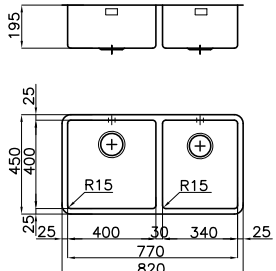





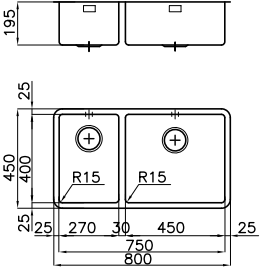

miscelatori consigliati

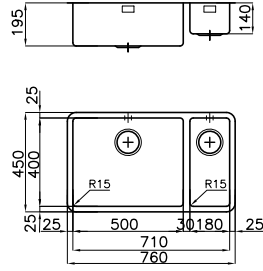
| | Caratteristiche | Versione | Sigla | Prezzo € | Disegno Tecnico |
|--|---|---|----------|----------|---|
| <p>Base 100</p>  <p>Accessori: (vedi pag. 131) L3 N2 N3 O2 P2 P4 S T T1 T2 Z Z2 Pilette autom.: PA PE PM PL PP PS (v. pag. 148-149)</p> | AISI 304 spazzolato vasca: 45x40/40x40 cm dimensioni: 930x450 incasso: vedi sito web piletta: 3½ |  | 2207 850 | € 702,00 |  |
| <p>Base 90</p>  <p>Accessori: (vedi pag. 131) L3 N2 N3 O2 P2 P4 S T T1 T2 Z Z2 Pilette autom.: PA PE PM PL PP PS (v. pag. 148-149)</p> | AISI 304 spazzolato vasca: 40x40/34x40 cm dimensioni: 820x450 incasso: vedi sito web piletta: 3½ |  | 2206 850 | € 654,00 |  |

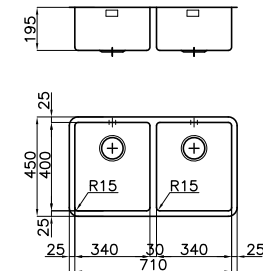
Dotazioni Standard: ganci di fissaggio, guarnizione (no per sottotop), piletta, troppopieno e sifone. Imballo in scatola di cartone.

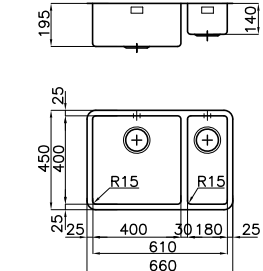

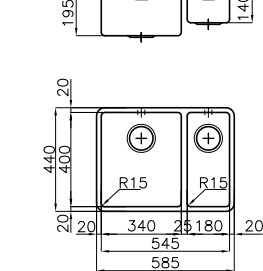









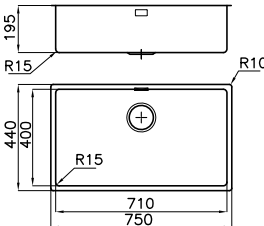



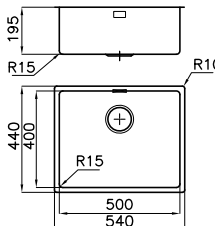

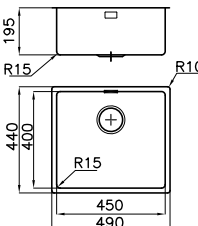

KE - R15

| | Caratteristiche | Versione | Sigla | Prezzo € | Disegno Tecnico |
|--|---|---|-------------|-----------------|---|
|  | AISI 304 spazzolato vasca: 45x40/27x40 cm dimensioni: 800x450 incasso: vedi sito web piletta: 3½ |  | 2205 850 | € 646,00 |  |
| | | | | | |
| Accessori: (vedi pag. 131) L3 L4 N2 N3 O2 P2 P4 S T T1 T2 Z Z2 | | | | | |
| Pilette autom.: PA PE PM PL PP PS (v. pag. 148-149) | | | | | |
|  | AISI 304 spazzolato vasca: 50x40/18x40 cm dimensioni: 760x450 incasso: vedi sito web piletta: 3½ |  | 2204 851 dx | € 616,00 |  |
| | | | 2204 852 sx | | |
| In foto versione sinistra | | | | | |
| Accessori: (vedi pag. 131) L3 L4 N2 N3 O2 P2 P4 S T T1 T2 Z Z2 | | | | | |
| Pilette autom.: PA PE PM PL PP PS (v. pag. 148-149) | | | | | |
|  | AISI 304 spazzolato vasca: (2x) 34x40 cm dimensioni: 760x450 incasso: vedi sito web piletta: 3½ |  | 2203 850 | € 583,00 |  |
| | | | | | |
| Accessori: (vedi pag. 131) L4 N2 N3 O2 P2 P4 R T1 T2 Z2 | | | | | |
| Pilette autom.: PA PE PM PL PP PS (v. pag. 148-149) | | | | | |
|  | AISI 304 spazzolato vasca: 40x40/18x40 cm dimensioni: 660x450 incasso: vedi sito web piletta: 3½ |  | 2202 851 dx | € 550,00 |  |
| | | | 2202 852 sx | | |
| In foto versione sinistra | | | | | |
| Accessori: (vedi pag. 131) L3 L4 N2 N3 O2 P2 P4 S T T1 T2 Z Z2 | | | | | |
| Pilette autom.: PA PE PM PL PP PS (v. pag. 148-149) | | | | | |
|  | AISI 304 spazzolato vasca: 34x40/18x40 cm dimensioni: 585x440 incasso: vedi sito web piletta: 3½ |  | 2201 851 dx | € 535,00 |  |
| | | | 2201 852 sx | | |
| In foto versione sinistra | | | | | |
| Accessori: (vedi pag. 131) L4 N2 N3 O2 P2 P4 R T2 T1 Z2 | | | | | |
| Pilette autom.: PA PE PM PL PP PS (v. pag. 148-149) | | | | | |

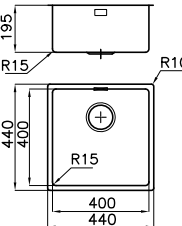
Dotazioni Standard: ganci di fissaggio, guarnizione (no per sottotop), piletta, troppo/pieno e sifone. Imballo in scatola di cartone.



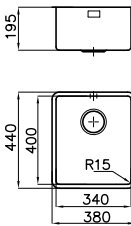

LAVELLI
SOTTOTOP

KE - R15

| | Caratteristiche | Versione | Sigla | Prezzo € | Disegno Tecnico |
|---|---|--|---|----------|---|
|  | AISI 304 spazzolato vasca: 71x40 cm dimensioni: 750x440 incasso: vedi sito web piletta: 3½ |  | 2157 850 | € 481,00 |  |
| | | versione Vintage  |  | 2157 880 | |
| Accessori: L3 L4 N2 N3 O2 P2 P4 S T T1 T2 Z Z2 Pilette autom.: PA PE PM PL PP PS (v. pag. 148-149) | | | | | |
|  | AISI 304 spazzolato vasca: 50x40 cm dimensioni: 540x440 incasso: vedi sito web piletta: 3½ |  | 2155 850 | € 403,00 |  |
| | | versione Vintage  |  | 2155 880 | |
| Accessori: L3 L4 N2 N3 O2 P2 P4 S T T1 T2 Z Z2 Pilette autom.: PA PE PM PL PP PS (v. pag. 148-149) | | | | | |
|  | AISI 304 spazzolato vasca: 45x40 cm dimensioni: 490x440 incasso: vedi sito web piletta: 3½ |  | 2154 850 | € 353,00 |  |
| | | versione Vintage  |  | 2154 880 | |
| Accessori: L3 L4 N2 N3 O2 P2 P4 S T T1 T2 Z Z2 Pilette autom.: PA PE PM PL PP PS (v. pag. 148-149) | | | | | |
|  | AISI 304 spazzolato vasca: 40x40 cm dimensioni: 440x440 incasso: vedi sito web piletta: 3½ |  | 2156 850 | € 337,00 |  |
| | | versione Vintage  |  | 2156 880 | |
| Accessori: L3 L4 N2 N3 O2 P2 P4 S T T1 T2 Z Z2 Pilette autom.: PA PE PM PL PP PS (v. pag. 148-149) | | | | | |
|  | AISI 304 spazzolato vasca: 34x40 cm dimensioni: 380x440 incasso: vedi sito web piletta: 3½ |  | 2153 850 | € 313,00 |  |
| | | versione Vintage  |  | 2153 880 | |
| Accessori: L4 N2 N3 O2 P2 P4 R T1 T2 Z2 Pilette autom.: PA PE PM PL PP PS (v. pag. 148-149) | | | | | |

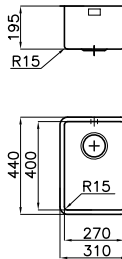
Dotazioni Standard: ganci di fissaggio, guarnizione (no per sottotop), piletta, troppo/pieno e sifone. Imballo in scatola di cartone.

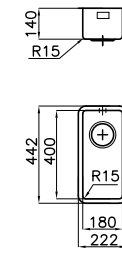
KE - R15

| | Caratteristiche | Versione | Sigla | Prezzo € | Disegno Tecnico |
|--|---|--|----------|----------|---|
| Base 40 | AISI 304 spazzolato vasca: 27x40 cm dimensioni: 310x440 incasso: vedi sito web piletta: 3½ |  ST | 2152 850 | € 295,00 |  |
|  | | | | | |
| Accessori: L4 N2 T1 | | | | | |
| Pilette autom.: PA PE PM PL PP PS (v. pag. 148-149) | | | | | |
| Base 30 | AISI 304 spazzolato vasca: 18x40 cm dimensioni: 222x442 incasso: vedi sito web piletta: 3½ |  ST | 2151 850 | € 275,00 |  |
|  | | | | | |
| Pilette autom.: PA PE PM PL PP PS (v. pag. 148-149) | | | | | |

Dotazioni Standard: ganci di fissaggio, guarnizione (no per sottotop), piletta, tropp/pieno e sifone. Imballo in scatola di cartone.

accessori

| | | | | | | | | | | | |
|---|---|---|--|---|--|---|---|---|--|---|--|
|  | L3 Tagliere Twin 41x41 cm 8644 004 € 242,00 |  | L4 Tagliere cristallo 23x41 cm 8631 300 € 96,00 |  | N2 Tagliere in HDPE 27,2x42,5 cm 8657 001 € 74,00 |  | N3 Tagliere Twin in HDPE 31,7x42,5 cm 8644 101 € 109,00 |  | O2 Vaschetta bianca 27,2x41,4 cm 8153 100 € 39,00 |  | P2 ** Kit grattugie con anello-supporto e vaschetta raccogli vivande - 8159 101 € 146,00 |
|  | P4 Kit tagliere con vaschetta scolapasta in acciaio inox 8644 044 € 278,00 |  | R Cestello Inox 34x40 cm 8611 000 € 50,00 |  | S Cestello Inox 40x40 8612 000 € 58,00 Cestello bianco 40x40 8612 100 € 37,00 |  | T * Griglia portapiatti inox 25x35 cm 8100 154 € 69,00 |  | Z * Scolapasta inox 25x36 cm 8154 000 € 187,00 |  | Z2 ** Vaschetta forata inox 21,5x38 cm 8151 000 € 279,00 |
|  | T1 Cestello portapiatti inox 25x42,5 cm 8100 201 € 87,00 |  | T2 ** Cestello portapiatti inox 21,4x37,9 cm 8100 303 € 93,00 | | | | | | | | |

*utilizzabile solo in abbinamento al tagliere L3 **utilizzabile solo in abbinamento al tagliere N3









KE PVD & PVD Vintage



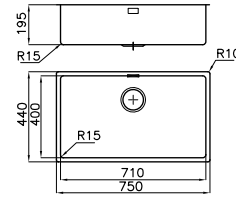



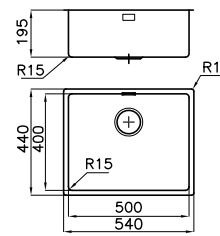



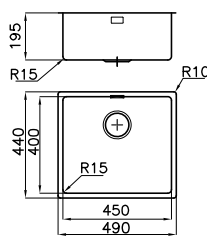

T/P perimetrale

Gun Metal, Gold, copper. Le nuove finiture KE Color sono ottenute con uno speciale trattamento superficiale (**Physical Vapor Deposition**) che conferisce all'acciaio AISI304 raffinate colorazioni, una particolare lucentezza, ed elevatissime caratteristiche fisiche e meccaniche. In particolare il trattamento dona una maggiore **resistenza alla corrosione**; l'aumento della **durezza superficiale**, e quindi una maggiore **resistenza ai graffi**; la riduzione del coefficiente di attrito superficiale e un **miglior scorrimento dell'acqua**; una più elevata **resistenza alla temperatura**.

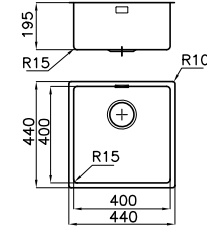
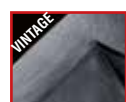
KE Gun Metal

| | Caratteristiche | Versione | Sigla | Prezzo € | Disegno Tecnico |
|---|--|---|--|------------|---|
| Base 80  | AISI 304 Gun Metal vasca: 71x40 cm dimensioni: 750x440 incasso: vedi sito web piletta: 3½ |  ST | 2157 856 | € 1.188,00 |  |
| | | versione Vintage  |  ST | 2157 886 | |
| Accessori: L3 L4 N2 N3 O2 P2 P4 S T T1 T2 Z Z2 Pilette autom.: PG PO (v. pag. 148-149) | | | | | |
| Base 60  | AISI 304 Gun Metal vasca: 50x40 cm dimensioni: 544x444 incasso: vedi sito web piletta: 3½ |  ST | 2155 856 | € 903,00 |  |
| | | versione Vintage  |  ST | 2155 886 | |
| Accessori: L3 L4 N2 N3 O2 P2 P4 S T T1 T2 Z Z2 Pilette autom.: PG PO (v. pag. 148-149) | | | | | |

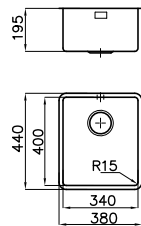
KE Gun Metal

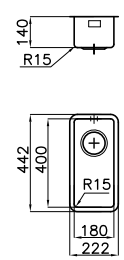
| | Caratteristiche | Versione | Sigla | Prezzo € | Disegno Tecnico |
|--|--|--|----------|----------|---|
| Base 60  | AISI 304 Gun Metal vasca: 45x40 cm dimensioni: 490x440 incasso: vedi sito web piletta: 3½ |  ST | 2154 856 | € 863,00 |  |
| Accessori: L3 L4 N2 N3 O2 P2 P4 S T T1 T2 Z Z2 Pilette autom.: PG PO (v. pag. 148-149) | | | | | |
| Base 45  | AISI 304 Gun Metal vasca: 40x40 cm dimensioni: 440x440 incasso: vedi sito web piletta: 3½ |  ST | 2156 856 | € 825,00 |  |
| Accessori: L3 L4 N2 N3 O2 P2 P4 S T T1 T2 Z Z2 Pilette autom.: PG PO (v. pag. 148-149) | versione Vintage  |  ST | 2156 886 | € 847,00 | |
| Base 40  | AISI 304 Gun Metal vasca: 34x40 cm dimensioni: 380x440 incasso: vedi sito web piletta: 3½ |  ST | 2153 856 | € 801,00 |  |
| Accessori: L4 N2 N3 O2 P2 P4 R T2 T1 Z2 Pilette autom.: PG PO (v. pag. 148-149) | | | | | |
| Base 30  | AISI 304 Gun Metal vasca: 18x40 cm dimensioni: 222x442 incasso: vedi sito web piletta: 3½ |  ST | 2151 856 | € 497,00 |  |
| Pilette autom.: PG PO (v. pag. 148-149) | | | | | |

Dotazioni Standard: ganci di fissaggio, guarnizione (no per sottotop), piletta, troppo/pieno e sifone. Imballo in scatola di cartone.

accessori

R S p. 131













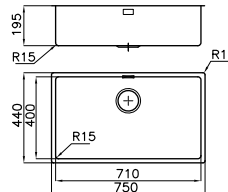



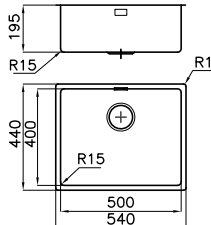

| | | | |
|--|--|--|--|
|  <p>PG Piletta automatica Gun metal 8407 110 € 93,00</p> |  <p>Miscelatori Omega Gun Metal pag. 181</p> |  <p>Miscelatore Skin Gun Metal pag. 166</p> |  <p>Dispenser Evo Gun Metal pag. 189</p> |
|  <p>L3 Tagliere Twin 41x41 cm 8644 004 € 242,00</p> |  <p>L4 Tagliere cristallo 23x41 cm 8631 300 € 96,00</p> |  <p>N2 Tagliere in HDPE 27,2x42,5 cm 8657 001 € 74,00</p> |  <p>N3 Tagliere Twin 31,7x42,5 cm 8644 101 € 109,00</p> |
|  <p>O2 Vaschetta bianca 27,2x41,4 cm 8153 100 € 39,00</p> |  <p>P2 ** Kit grattugie con anello-supporto e vaschetta raccogli vivande - 8159 101 € 146,00</p> |  <p>P4 Kit tagliere con vaschetta scolapasta in acciaio inox 8644 044 € 278,00</p> |  <p>T * Griglia portapiatti inox 25x35 cm 8100 154 € 69,00</p> |
|  <p>T1 Cestello portapiatti inox 25x42,5 cm 8100 201 € 87,00</p> |  <p>T2 ** Cestello portapiatti inox 21,4x37,9 cm 8100 303 € 93,00</p> |  <p>Z * Scolapasta inox 25x36 cm 8154 000 € 187,00</p> |  <p>Z2 ** Vaschetta forata inox 21,5x38 cm 8151 000 € 279,00</p> |

*utilizzabile solo in abbinamento al tagliere L3 **utilizzabile solo in abbinamento al tagliere N3

LAVELLI SOTTOTOP

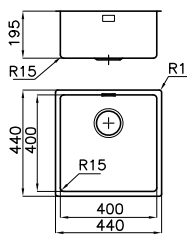
KE Gold



| | Caratteristiche | Versione | Sigla | Prezzo € | Disegno Tecnico |
|--|---|---|--|------------|---|
| Base 80  | AISI 304 Gold vasca: 71x40 cm dimensioni: 750x440 incasso: vedi sito web piletta: 3½ |  ST | 2157 859 | € 1.188,00 |  |
| | | versione Vintage  |  ST | 2157 889 | |
| Accessori (v. pag 136): L3 L4 N2 N3 O2 P2 P4 S T T1 T2 Z Z2 Pilette autom.: PD (pag. 148-149) | | | | | |
| | |  Mixer Gold pag. 182 | | | |
| Base 60  | AISI 304 Gold vasca: 50x40 cm dimensioni: 544x444 incasso: vedi sito web piletta: 3½ |  ST | 2155 859 | € 903,00 |  |
| | | versione Vintage  |  ST | 2155 889 | |
| Accessori (v. pag 136): L3 L4 N2 N3 O2 P2 P4 S T T1 T2 Z Z2 Pilette autom.: PD (pag. 148-149) | | | | | |
| | |  Mixer Gold pag. 182 | | | |
| Base 45  | AISI 304 Gold vasca: 40x40 cm dimensioni: 440x440 incasso: vedi sito web piletta: 3½ |  ST | 2156 859 | € 825,00 |  |
| | | versione Vintage  |  ST | 2156 889 | |
| Accessori (v. pag 136): L3 L4 N2 N3 O2 P2 P4 S T T1 T2 Z Z2 Pilette autom.: PD (pag. 148-149) | | | | | |
| | |  Mixer Gold pag. 182 | | | |

Dotazioni Standard: ganci di fissaggio, guarnizione (no per sottotop), piletta, troppol/pieno e sifone. Imballo in scatola di cartone.

KE Copper



LAVELLI
SOTTOTOP

| | Caratteristiche | Versione | Sigla | Prezzo € | Disegno Tecnico |
|--|-----------------|----------|-------|----------|-----------------|
|--|-----------------|----------|-------|----------|-----------------|

Base 80



AISI 304 **Copper**
vasca: **71x40 cm**
dimensioni: 750x440
incasso: vedi sito web
piletta: 3½

 ST 2157 858

€ 1.188,00

versione **Vintage**



 ST 2157 888

€ 1.379,00

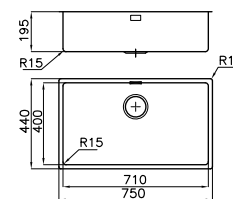

Accessori (v. pag 136):

L3 L4 N2 N3 O2 P2 P4 S T T1 T2 Z Z2

Pilette autom.: **PB** (pag. 148-149)



Mixer Copper
pag. 182

Base 60



AISI 304 **Copper**
vasca: **50x40 cm**
dimensioni: 544x444
incasso: vedi sito web
piletta: 3½

 ST 2155 858

€ 903,00

versione **Vintage**



 ST 2155 888

€ 952,00

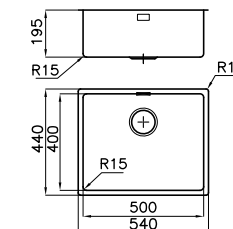

Accessori (v. pag 136):

L3 L4 N2 N3 O2 P2 P4 S T T1 T2 Z Z2

Pilette autom.: **PB** (pag. 148-149)



Mixer Copper
pag. 182

Base 45



AISI 304 **Copper**
vasca: **40x40 cm**
dimensioni: 440x440
incasso: vedi sito web
piletta: 3½

 ST 2156 858

€ 825,00

versione **Vintage**



 ST 2156 888

€ 847,00

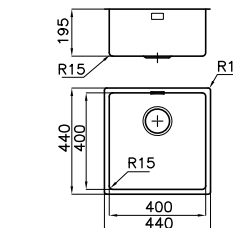

Accessori (v. pag 136):

L3 L4 N2 N3 O2 P2 P4 S T T1 T2 Z Z2





Pilette autom.: **PB** (pag. 148-149)



Mixer Copper
pag. 182

Dotazioni Standard: ganci di fissaggio, guarnizione (no per sottotop), piletta, troppo/pieno e sifone. Imballo in scatola di cartone.

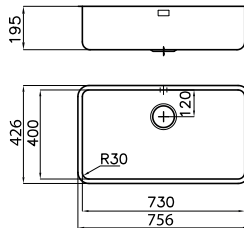
S400

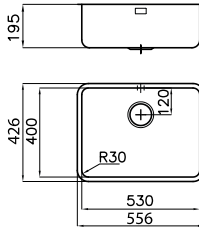
| | Caratteristiche | Versione | Sigla | Prezzo € | Disegno Tecnico |
|---|--|---|----------|----------|---|
| Base 80  | AISI 304 spazzolato vasca: 73x40 cm dimensioni: 756x426 incasso: vedi sito web piletta: 3½" |  | 1870 850 | € 354,00 |  |
| Accessori: L3 N2 N3 O2 P2 P4 S T T1 T2 Z Z2 | | | | | |
| Pilette automatiche: PA PE PM PL PP PS (v. pag. 148-149) | | | | | |
| Base 60  | AISI 304 spazzolato vasca: 53x40 cm dimensioni: 556x426 incasso: vedi sito web piletta: 3½" |  | 1865 850 | € 296,00 |  |
| Accessori: L3 N2 N3 O2 P2 P4 S T T1 T2 Z Z2 | | | | | |
| Pilette automatiche: PA PE PM PL PP PS (v. pag. 148-149) | | | | | |









Dotazioni Standard: ganci di fissaggio, guarnizione (no per sottotop), piletta, troppo/pieno e sifone. Imballo in scatola di cartone.

accessori

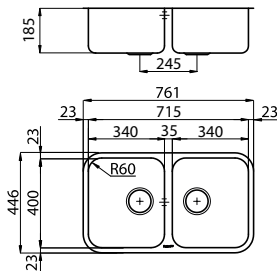
| | | | | |
|---|---|---|--|---|
|  <p>A Tagliere 34x40 8647 000 € 92,00</p> |  <p>E Tagliere 45x40 8655 000 € 76,00</p> |  <p>L3 Tagliere Twin 41x41 cm 8644 004 € 242,00</p> |  <p>L4 Tagliere cristallo 23x41 cm 8631 300 € 96,00</p> |  <p>N2 Tagliere in HDPE 27,2x42,5 cm 8657 001 € 74,00</p> |
|  <p>N3 Tagliere Twin in HDPE 31,7x42,5 cm 8644 101 € 109,00</p> |  <p>O2 Vaschetta bianca 27,2x41,4 cm 8153 100 € 39,00</p> |  <p>P2 ** Kit grattugie con anello-supporto e vaschetta raccogli vivande - 8159 101 € 146,00</p> |  <p>P4 Kit tagliere con vaschetta scolapasta in acciaio inox 8644 044 € 278,00</p> | |
|  <p>R Cestello Inox 34x40 cm 8611 000 € 50,00</p> |  <p>S Cestello Inox 40x40 8612 000 € 58,00 Cestello bianco 40x40 8612 100 € 37,00</p> |  <p>T * Griglia portapiatti inox 25x35 cm 8100 154 € 69,00</p> |  <p>T1 Cestello portapiatti inox 25x42,5 cm 8100 201 € 87,00</p> | |
|  <p>T2 ** Cestello portapiatti inox 21,4x37,9 cm 8100 303 € 93,00</p> |  <p>T4 Griglia portapiatti inox 25x43 cm 8100 301 € 87,00</p> |  <p>Z * Scolapasta inox 25x36 cm 8154 000 € 187,00</p> |  <p>Z2 ** Vaschetta forata inox 21,5x38 cm 8151 000 € 279,00</p> | |

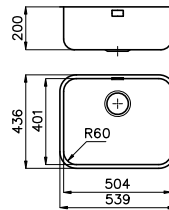
*utilizzabile solo in abbinamento al tagliere L3 **utilizzabile solo in abbinamento al tagliere N3

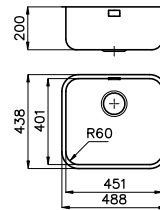

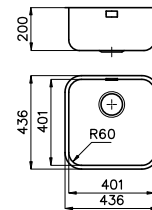



KS

| | Caratteristiche | Versione | Sigla | Prezzo € | Disegno Tecnico |
|--|--|---|----------|----------|---|
| <p>Base 80</p>  <p>NEW</p> | <p>AISI 304 spazzolato vasca: (2x) 34x40 cm dimensioni: 761x446 incasso: vedi sito web piletta: 3½"</p> |  | 1303 860 | € 439,00 |  |
| <p>Accessori (v. pag. 136): A L4 N2 O2 R T1</p> <p>Pilette automatiche: PR PQ PC (v. pag. 148-149)</p> | | | | | |
| <p>Base 60</p>  | <p>AISI 304 spazzolato vasca: 50x40 cm dimensioni: 539x436 incasso: vedi sito web piletta: 3½"</p> |  | 1850 850 | € 199,00 |  |
| <p>Accessori: L4 N2 O2 S T1</p> <p>Pilette automatiche: PL PP PS PA PE PM (v. pag. 148-149)</p> | | | | | |
| <p>Base 60</p>  | <p>AISI 304 spazzolato vasca: 45x40 cm dimensioni: 488x438 incasso: vedi sito web piletta: 3½"</p> |  | 1845 850 | € 193,00 |  |
| <p>Accessori: L4 N2 O2 S T1</p> <p>Pilette automatiche: PL PP PS PA PE PM (v. pag. 148-149)</p> | | | | | |
| <p>Base 45</p>  | <p>AISI 304 spazzolato vasca: 40x40 cm dimensioni: 436x436 incasso: vedi sito web piletta: 3½"</p> |  | 1840 850 | € 183,00 |  |
| <p>Accessori: L4 N2 O2 S T1</p> <p>Pilette automatiche: PL PP PS PA PE PM (v. pag. 148-149)</p> | | | | | |

Dotazioni Standard: ganci di fissaggio, guarnizione (no per sottotop), piletta, troppol/pieno e sifone. Imballo in scatola di cartone.

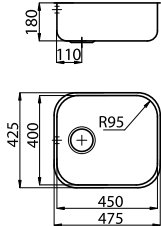

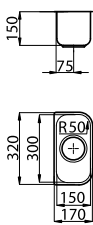
LAVELLI
SOTTOTOP

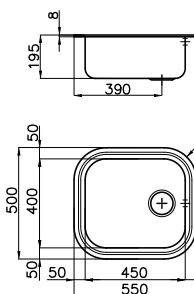
Big Bowl

| | Caratteristiche | Versione | Sigla | Prezzo € | Disegno Tecnico |
|---|---|--|----------|----------|--|
| <p>Base 60</p>  | <p>AISI 304 spazzolato vasca: 45x40 cm dimensioni: 475x425 incasso: vedi sito web piletta: 3½"</p> |  | 1811 050 | € 178,00 |  |
| <p>Accessori (vedi pag.136): L4 N2 S T4 Pilette automatiche: PR PQ PC (v. pag. 148-149)</p> | | | | | |
| <p>Base 30</p>  | <p>AISI 304 spazzolato vasca: 15x30 cm dimensioni: 170x320 incasso: vedi sito web piletta: 3½"</p> |  | 1300 068 | € 117,00 |  |
| <p>Pilette automatiche: PR PQ PC (v. pag. 148-149)</p> | | | | | |
| <p>Base 60</p>  | <p>AISI 304 spazzolato vasca: 45x40 cm dimensioni: 550x500 incasso: vedi sito web piletta: 3½"</p> |  | 1611 068 | € 226,00 |  |
| <p>Accessori (vedi pag.136): E L4 N2 S Pilette automatiche: PR PQ PC (v. pag. 148-149)</p> | | | | | |



Dotazioni Standard: ganci di fissaggio, guarnizione (no per sottotop), piletta, troppo/pieno e sifone. Imballo in scatola di cartone.

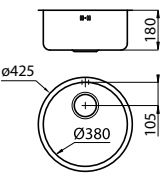

Circolari NEW

| | Caratteristiche | Versione | Sigla | Prezzo € | Disegno Tecnico |
|---|--|---|----------|----------|---|
| <p>Base 45</p>  | <p>AISI 304 spazzolato vasca: Ø 38 cm dimensioni: Ø 425 incasso: vedi sito web piletta: 3½"</p> |  | 1130 860 | € 174,00 |  |
| <p>Pilette automatiche: PR PQ PC (v. pag. 148-149)</p> | | | | | |

Dotazioni Standard: ganci di fissaggio, guarnizione (no per sottotop), piletta, troppo/pieno e sifone. Imballo in scatola di cartone.

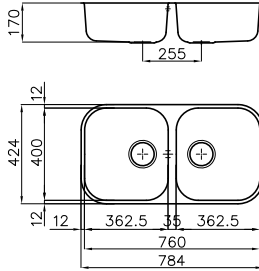

Elettra

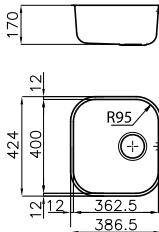
| | Caratteristiche | Versione | Sigla | Prezzo € | Disegno Tecnico |
|--|--|---|----------|----------|---|
| Base 80  | AISI 304 spazzolato vasche: (2x) 36x40 cm dimensioni: 790x430 incasso: vedi sito web piletta: 3½" |  | 1974 860 | € 307,00 |  |
| Accessori (vedi pag.136): L4 N2 R T1 T4 Pilette automatiche: PR PQ PC (v. pag. 148-149) | | | | | |

| | | | | | |
|--|--|---|----------|----------|---|
| Base 45  | AISI 304 spazzolato vasca: 36x40 cm dimensioni: 386,5x424 incasso: vedi sito web piletta: 3½" |  | 1970 860 | € 149,00 |  |
| Accessori (vedi pag.136): L4 N2 R T1 T4 Pilette automatiche: PR PQ PC (v. pag. 148-149) | | | | | |

Dotazioni Standard: ganci di fissaggio, guarnizione (no per sottotop), piletta, troppopieno e sifone. Imballo in scatola di cartone.

Tornado

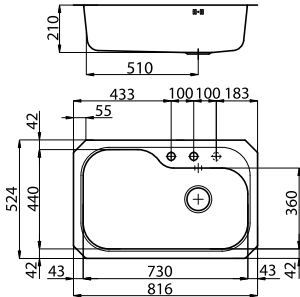
| | Caratteristiche | Versione | Sigla | Prezzo € | Disegno Tecnico |
|---|--|---|----------|----------|---|
| Base 80  | AISI 304 spazzolato vasca: 73x44 cm dimensioni: 816x524 incasso: vedi sito web piletta: automatica 3½" |  | 1679 860 | € 498,00 |  |
| Accessori: H I L2 O Q T U Z | | | | | |
| Possibilità terzo foro | | | | | |

accessori Tornado



H
Tagliere
37x30
8659 111
€ 72,00



I
Tagliere
37x46 cm
8659 112
€ 78,00



L2
Tagliere Twin
37x46 cm
8644 003
€ 230,00



O
Vaschetta bianca
36x30 cm
8152 100
€ 44,00



Q
Scolapasta bianco
17x32 cm
8151 100
€ 32,00

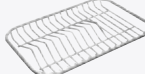

T *
Griglia portapiatti
25x35 cm
8100 154
€ 69,00



U
Griglia portapiatti
inox 25x45 cm
8100 111
€ 83,00



Z
Scolapasta inox
25x36 cm
8154 000
€ 187,00

*utilizzabile solo in abbinamento al tagliere L2



ACCESSORI e COMPLEMENTI



Accessori lavaggio
p. 142



Pilette automatiche
e Complementi lavaggio
p. 148



Pattumiere
p. 151



Porta prese
elettriche
p. 152



Accessori Lavelli

Una dotazione sempre più ricca di accessori caratterizza le proposte lavaggio. Tutti i modelli si accompagnano con **taglieri**, **vaschette**, **griglie scolapiatti** e **colapasta** che arricchiscono l'estetica e la funzionalità del lavello.

Taglieri Twin



I taglieri Twin sono molto di più di semplici taglieri. Abbinati a cestelli e scolapasta diventano sistemi multifunzione salvaspazio. Nella foto, il tagliere **L3** si accompagna alla griglia scolapiatti **T** e il colapasta **Z**.

Accessori Lavelli - set modulari

Spazio e tempo, elementi sempre più preziosi in cucina.

Per questo Foster ha studiato **sistemi integrati di accessori che ottimizzano ogni vostro movimento**, e si riducono al minimo ingombro quando non li usate.

Le grandi vasche... pluriaccessoriate



La gamma Foster è particolarmente ricca di **lavelli con una grande monovasca**. Dal punto di vista funzionale questa è infatti la soluzione ottimale: un unico capiente bacino che possa contenere stoviglie e oggetti di notevoli dimensioni, accessorato con vaschette, cestelli e taglieri che rendano la zona di lavoro flessibile e perfettamente funzionale.

Nella foto, il tagliere **N2** si accompagna con la vaschetta **O2** e la griglia **T1**, per formare un set completo di grande eleganza.

Un kit multiuso



Il tagliere Twin **N3** in Hdpe, si combina con il nuovo **kit P2** per accogliere grattugie e la sottostante vaschetta di contenimento. Altri accessori possono essere inseriti nell'anello esterno del tagliere, come il cestello scolapiatti **T2** o il vassoio colapasta **Z2**.

Accessori Lavelli

Taglieri in legno



A
Tagliere in legno Iroko 34x40 cm
8647 000 - € 92,00



B6
Tagliere 26x36,6 cm
8643 117 - € 71,00



E
Tagliere in legno Iroko 45x40 cm
8655 000 - € 76,00



M
Tagliere scorrevole in legno Iroko - 30x54 cm
8643 000 - € 114,00



M2
Tagliere in legno Iroko 28x48 cm
8643 115 - € 66,00



M4
Tagliere scorrevole in legno Iroko - 44,4x33,7 cm
8656 001 - € 110,00



L2
Tagliere Twin in legno Iroko 37x46 cm
8644 003 - € 230,00
Articolo ad esaurimento



L3
Tagliere Twin in legno Iroko 41x41 cm
8644 004 - € 242,00



P4 NEW
Kit tagliere in legno 42x31,7 cm
con vaschetta scolapasta in acciaio inox
8644 044 - € 278,00

Taglieri in HDPE e kit



N2
Tagliere in HDPE 27,2x42,5 cm
8657 001 - € 74,00



N3
Tagliere Twin in HDPE 31,7x42,5 cm
8644 101 - € 109,00



N4
Tagliere Twin in HDPE 44,4x31,7 cm
8644 100 - € 121,00



G
Tagliere in legno Iroko 40x40 cm
8646 000 - € 110,00
Articolo ad esaurimento



H
Tagliere in legno Iroko 37x30 cm
8659 111 - € 72,00



I
Tagliere in legno Iroko 37x46 cm
8659 112 - € 78,00



M5
Tagliere scorrevole in legno Iroko 33,2x38,4 cm
8659 113 - € 80,00



M6
Tagliere legno noce 18x44,8 cm
8642 000 - € 85,00



M7
Tagliere legno noce 15,8x42,4 cm
8642 003 - € 83,00

Taglieri in cristallo



P6
Kit Cestello+ scolapasta+Tagliere
8100 151 - € 190,00



L4
Tagliere in cristallo 23x41 cm
8631 300 - € 96,00



L5
Tagliere in cristallo 29x54 cm
8633 300 - € 110,00

Griglie



N5
Kit cornice supporto 28x47,4
multiaccessori con tagliere HDPE
8100 627 - € 282,00

NEW



P2 *
Kit grattugie con anello-supporto
e vaschetta raccogli vivande
8159 101 - € 146,00



P3
Griglia Black 39,2x44,8 cm
8100 600 - € 262,00

* Modello da abbinare ai taglieri N3 e N4

Accessori Lavelli

Scolapiatti



T **

Griglia portapiatti inox 25x35 cm
8100 154 - € 69,00

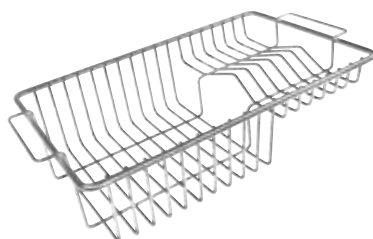

T1

Cestello portapiatti inox 25x42,5 cm
8100 201 - € 87,00

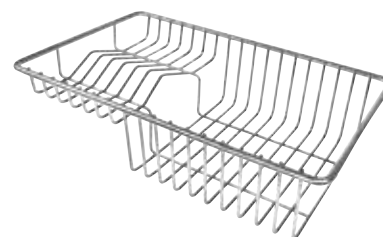

T2

Cestello portapiatti inox 21,4x37,9 cm
8100 303 - € 93,00

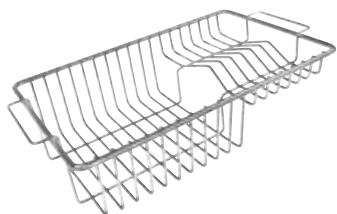

T6

Griglia portapiatti inox 23x37,5 cm
8100 305 - € 83,00

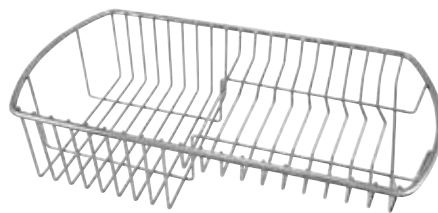

T7

Griglia portapiatti 23,8x46 cm
8100 051 - € 93,00

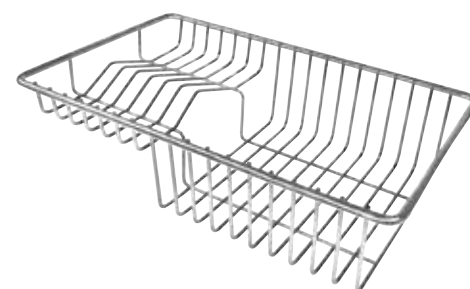

T8

Griglia portapiatti 21,4x37,2 cm
8100 306 - € 80,00

Vaschette e cestelli per vasche



O

Vaschetta bianca 36x30 cm
8152 100 - € 44,00



O2

Vaschetta bianca 41,4x27,2 cm
8153 100 - € 39,00

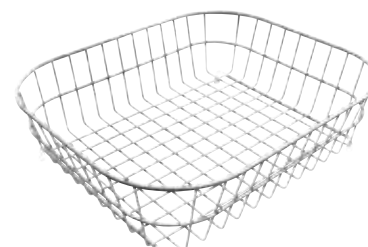

R

Cestello inox 34x40 cm
8611 000 - € 50,00

Scolapasta



X

Scolapasta inox 17x32 cm
8154 043 - € 146,00

NEW



Q

Scolapasta bianco 17x32 cm
8151 100 - € 32,00



Z **

Scolapasta inox 25x36 cm
8154 000 - € 187,00

** Modello da abbinare ai taglieri L2 e L3



T3
Griglia portapiatti inox 28x40 cm
8100 280 - € 98,00

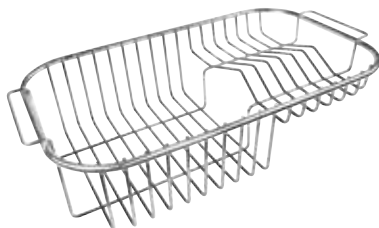

T4
Cestello portapiatti inox 25x43 cm
8100 301 - € 87,00

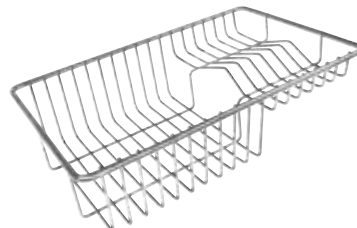

T5
Cestello portapiatti inox 21,4x33,1 cm
8100 304 - € 84,00

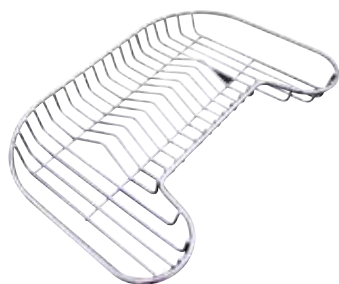

U
Griglia portapiatti inox 25x45 cm
8100 111 - € 83,00



U2
Griglia portapiatti inox 23x47 cm
8100 115 - € 78,00



V
Portavaschetta 37x45 cm
8100 112 - € 60,00



S
Cestello inox 40x40 cm
8612 000 - € 58,00



S1
Cestello bianco 40x40 cm
8612 100 - € 37,00



Z2
Vaschetta forata inox 21,5x38 cm
8151 000 - € 279,00













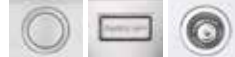

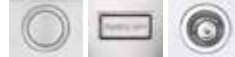







Z3
Vaschetta forata inox 21,5x40 cm
8156 000 - € 274,00

** Modello da abbinare ai taglieri L2 e L3

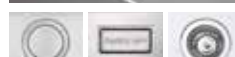
Complementi

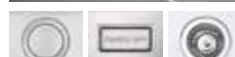
Pilette automatiche SPACE

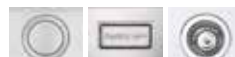
| | | | | | | |
|--|--|--|-------|----------|----------|-----------------|
| PL  |   | <p>Piletta automatica Space Light con comando remoto ad azionamento elettrico luminoso e con troppo/pieno perimetrale. Doppio tappo in dotazione: Space e "a cestello".</p> <table border="1"> <tr> <td>Sigla</td> <td>Prezzo €</td> </tr> <tr> <td>8407 117</td> <td>€ 184,00</td> </tr> </table> | Sigla | Prezzo € | 8407 117 | € 184,00 |
| Sigla | Prezzo € | | | | | |
| 8407 117 | € 184,00 | | | | | |
| PP  |   | <p>Piletta automatica Space Push con comando remoto rotondo a pressione e con troppo/pieno perimetrale. Doppio tappo in dotazione: Space e "a cestello".</p> <table border="1"> <tr> <td>Sigla</td> <td>Prezzo €</td> </tr> <tr> <td>8407 116</td> <td>€ 81,00</td> </tr> </table> | Sigla | Prezzo € | 8407 116 | € 81,00 |
| Sigla | Prezzo € | | | | | |
| 8407 116 | € 81,00 | | | | | |
| PO  |   | <p>Piletta automatica Space Push Gun Metal con comando remoto rotondo a pressione e con troppo/pieno perimetrale. Doppio tappo in dotazione: Space e "a cestello".</p> <table border="1"> <tr> <td>Sigla</td> <td>Prezzo €</td> </tr> <tr> <td>8407 120</td> <td>€ 150,00</td> </tr> </table> | Sigla | Prezzo € | 8407 120 | € 150,00 |
| Sigla | Prezzo € | | | | | |
| 8407 120 | € 150,00 | | | | | |
| PB  |   | <p>Piletta automatica Space Push Copper con comando remoto rotondo a pressione e con troppo/pieno perimetrale. Doppio tappo in dotazione: Space inox e "a cestello".</p> <table border="1"> <tr> <td>Sigla</td> <td>Prezzo €</td> </tr> <tr> <td>8407 122</td> <td>€ 172,00</td> </tr> </table> | Sigla | Prezzo € | 8407 122 | € 172,00 |
| Sigla | Prezzo € | | | | | |
| 8407 122 | € 172,00 | | | | | |
| PD  |   | <p>Piletta automatica Space Push Gold con comando remoto rotondo a pressione e con troppo/pieno perimetrale. Doppio tappo in dotazione: Space inox e "a cestello".</p> <table border="1"> <tr> <td>Sigla</td> <td>Prezzo €</td> </tr> <tr> <td>8407 121</td> <td>€ 172,00</td> </tr> </table> | Sigla | Prezzo € | 8407 121 | € 172,00 |
| Sigla | Prezzo € | | | | | |
| 8407 121 | € 172,00 | | | | | |
| PS  |   | <p>Piletta automatica Space Milano con comando remoto rotondo rotante e con troppo/pieno perimetrale. Doppio tappo in dotazione: Space e "a cestello".</p> <table border="1"> <tr> <td>Sigla</td> <td>Prezzo €</td> </tr> <tr> <td>8407 115</td> <td>€ 89,00</td> </tr> </table> | Sigla | Prezzo € | 8407 115 | € 89,00 |
| Sigla | Prezzo € | | | | | |
| 8407 115 | € 89,00 | | | | | |
| PA  |   | <p>Piletta automatica Space con comando remoto quadrato rotante e con troppo/pieno perimetrale. Doppio tappo in dotazione: Space e "a cestello".</p> <table border="1"> <tr> <td>Sigla</td> <td>Prezzo €</td> </tr> <tr> <td>8407 108</td> <td>€ 96,00</td> </tr> </table> | Sigla | Prezzo € | 8407 108 | € 96,00 |
| Sigla | Prezzo € | | | | | |
| 8407 108 | € 96,00 | | | | | |
| PE  |   | <p>Piletta automatica Space con comando remoto rotondo rotante e con troppo/pieno perimetrale. Doppio tappo in dotazione: Space e "a cestello".</p> <table border="1"> <tr> <td>Sigla</td> <td>Prezzo €</td> </tr> <tr> <td>8407 109</td> <td>€ 83,00</td> </tr> </table> | Sigla | Prezzo € | 8407 109 | € 83,00 |
| Sigla | Prezzo € | | | | | |
| 8407 109 | € 83,00 | | | | | |

Caratteristiche Pilette automatiche SPACE



Pensato per vasche profonde, Space ha un ingombro molto contenuto.

Nel disegno è presentata la vista laterale del sistema Space. L'altezza ridotta della piletta e la conformazione del sifone ottimizzano l'area sotto-lavello lasciando lo spazio necessario per le esigenze di raccolta differenziata.



Il tappo Space raccoglie i residui alimentari nel **cestello flessibile in neoprene** sottostante, molto facile da pulire.



Le nuove pilette automatiche **Space Light e Push** sono ancora più comode e permettono l'apertura dello scarico con un semplice tocco della mano.

Complementi

Pilette automatiche

PM

Piletta automatica con comando remoto **quadrato rotante** e con troppo/pieno perimetrale

| | |
|----------|----------|
| Sigla | Prezzo € |
| 8407 113 | € 46,00 |

PG

Piletta automatica **Gun metal** con comando remoto **tondo rotante** e con troppo/pieno perimetrale

| | |
|----------|----------|
| Sigla | Prezzo € |
| 8407 110 | € 93,00 |

PR

Piletta automatica con comando remoto **tondo rotante** e con troppo/pieno

| | |
|----------|----------|
| Sigla | Prezzo € |
| 8407 100 | € 50,00 |

Piletta automatica con comando remoto **tondo rotante** e senza troppo/pieno

| | |
|----------|----------|
| Sigla | Prezzo € |
| 8407 000 | € 45,00 |

PQ

Piletta automatica **LIRA** con comando remoto **quadrato rotante** e con troppo/pieno

| | |
|----------|----------|
| Sigla | Prezzo € |
| 8407 102 | € 78,00 |

PC

Piletta automatica **LIRA** con comando remoto **cubico push-pull** e con troppo/pieno

| | |
|----------|----------|
| Sigla | Prezzo € |
| 8407 103 | € 78,00 |

Note sulla compatibilità delle pilette automatiche

Le pilette automatiche sono compatibili con lavelli che hanno in dotazione almeno un secondo foro (oltre a quello del miscelatore).

Per molti lavelli questa non è una dotazione standard ma è possibile richiederla in fase d'ordine. Nei disegni dei lavelli sono riportati con tratto continuo i fori in dotazione standard, con tratteggio sottile le posizioni per eventuali fori su richiesta (vedi esempio qui sotto).

Per i lavelli sottotop è sempre segnalata la possibilità di inserimento della piletta automatica in quanto il foro è posizionabile sul piano di lavoro. Si raccomanda inoltre di controllare la tipologia del troppo-pieno del lavello per scegliere una piletta automatica compatibile.

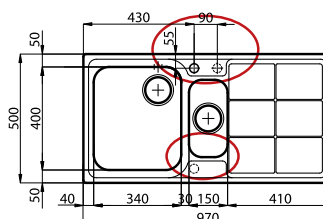









Possibilità secondo e terzo foro

Complementi

Piletta SPACE 3"½

| | Sigla | Descrizione | Prezzo € |
|---|----------|---|----------|
|  | 8403 008 | Piletta Space senza troppo pieno | € 52,00 |
|  | 8403 308 | Piletta Space con troppo pieno perimetrale | € 60,00 |
|  | 8403 315 | Piletta Space con TP per livello CQ | € 60,00 |
|  | 8669 012 | Tappo inox Space con cestello in silicone senza foro per pilette autom. | € 17,00 |
|  | 8669 011 | Tappo inox Space con cestello in silicone con foro per pilette manuali | € 16,00 |



Pilette 3"½

| | Sigla | Descrizione | Prezzo € |
|--|----------|--|----------|
|  | 8403 000 | Piletta basket senza troppo pieno | € 28,00 |
|  | 8403 014 | Piletta basket satinata senza troppo pieno | € 25,00 |
|  | 8403 303 | Piletta basket con troppo pieno perimetrale | € 24,00 |
|  | 8403 310 | Piletta troppo pieno a mostrina 3,5" gun metal | € 65,00 |
|  | 8403 312 | Piletta troppo pieno a mostrina 3,5" copper | € 65,00 |
|  | 8403 311 | Piletta troppo pieno a mostrina 3,5" gold | € 65,00 |
|  | 8403 300 | Piletta basket con troppo pieno | € 32,00 |
|  | 8407 200 | Piletta Uragano per vasca profonda (t/p con tubo flessibile) | € 32,00 |

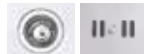
Pilette Lira 3"½

| | Sigla | Descrizione | Prezzo € |
|---|----------|--|----------|
|  | 8403 001 | Piletta Basket LIRA senza troppo pieno | € 26,00 |
|  | 8403 301 | Piletta Basket LIRA con troppo pieno | € 60,00 |

Pilette 2"

| | Sigla | Descrizione | Prezzo € |
|---|----------|---|----------|
|  | 8401 000 | Piletta 2" con tappo a maniglia con troppo pieno | € 3,00 |
|  | 8402 000 | Set pilette 2" con tappo a maniglia 1 con t/p + 1 senza t/p | € 5,00 |





Piletta 1"¼

| | Sigla | Descrizione | Prezzo € |
|--|----------|---|----------|
|  | 8404 000 | Piletta-troppo pieno 1"¼ per gocciolatoio | € 5,00 |



Piletta 7"

| | Sigla | Descrizione | Prezzo € |
|---|----------|---|----------|
|  | 8403 309 | Piletta-troppo pieno 7" con cestello inox | € 182,00 |

Sifoni

| | Sigla | Descrizione | Prezzo € |
|--|----------|--|----------|
|  | 8410 000 | Sifone a 1 via con attacco lavastoviglie | € 7,00 |
|  | 8415 000 | Sifone a 2 vie con attacco lavastoviglie | € 7,00 |
|  | 8435 000 | Sifone tipo "Spazio" a 2 vie con attacco lavastoviglie | € 17,00 |
|  | 8433 000 | Sifone tipo "Spazio" a 3 vie con attacco lavastoviglie | € 24,00 |

Sifoni Lira salvaspazio

| | Sigla | Descrizione | Prezzo € |
|--|----------|--|----------|
|  | 8435 001 | Sifone LIRA* tipo "Spazio" a 1 via con attacco lavastoviglie | € 27,00 |
|  | 8435 002 | Sifone LIRA* tipo "Spazio" a 2 vie con attacco lavastoviglie | € 36,00 |
|  | 8435 003 | Sifone LIRA* ispezionabile a 1 via con attacco lavastoviglie | € 36,00 |

* si consiglia di abbinare sifoni e pilette tipo LIRA

Sifoni a pavimento

| Sigla | Descrizione | Prezzo € |
|----------|--|----------|
| 8411 000 | Sifone a pavimento 1 via con attacco lavastoviglie | € 8,00 |
| 8416 000 | Sifone a pavimento 2 vie con attacco lavastoviglie | € 12,00 |

Varie

| Sigla | Descrizione | Prezzo € |
|----------|--|----------|
| 8669 000 | Tappo a maniglia in gomma 2" | € 1,00 |
| 8669 018 | Tappo a cestello per piletta 3"½ | € 4,00 |
| 8669 019 | Tappo a cestello per piletta automatica 3"½ | € 5,00 |
| 8669 003 | Tappo a cestello per piletta LIRA 3"½ | € 14,00 |
| 8669 004 | Tappo a cestello per piletta automatica LIRA 3"½ | € 11,00 |
| 8155 000 | Tappo ricoperto inox 18/10 per pattumiere cod. 8113-8123 | € 48,00 |
| 8700 007 | Sigillante per incasso lavelli con bordo da 4 e 8 mm | € 3,00 |
| 8700 062 | Sigillante per incasso lavelli con bordo ribassato e filotop | € 2,00 |
| 8700 080 | Kit 18 adattatori per fissaggio ganci su top da 20 mm * | € 9,00 |
| 8669 009 | Mostrina STD per T/p perimetrale con logo con supporto | € 5,00 |
| 8669 008 | Kit mostrina lunga per T/p perimetrale con logo con supporto | € 17,00 |
| 8401 001 | Prolunga collegamento piletta/TP 15 cm | € 2,00 |

Complementi

Pattumiere



| | |
|----------|----------|
| Sigla | Prezzo € |
| 8143 000 | € 75,00 |

Split 2
 Sistema per raccolta differenziata
 a 2 scomparti 12+12L estraibile
 Base min 30 cm
 Coperchi colorati per facile
 riconoscimento scomparti

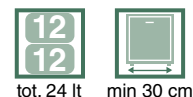
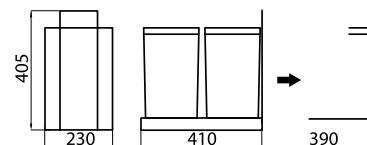

| | |
|----------|----------|
| Sigla | Prezzo € |
| 8144 000 | € 81,00 |

Split 4
 Sistema per raccolta differenziata
 a 4 scomparti 15+15+6+6L
 Per base a cassettoni 60 e 90 cm
 Scomparti modulari, coperchi colorati
 per facile riconoscimento scomparti

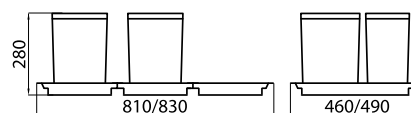

| | |
|----------|----------|
| Sigla | Prezzo € |
| 8113 800 | € 202,00 |

Articolo ad esaurimento

Patty 1 via
 Pattumiera con accesso dal top
 a 1 via (capienza 20 litri).
 Tappo e rivestimento in acciaio.

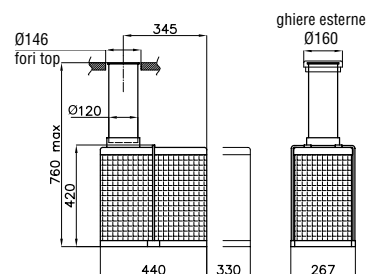

| | |
|----------|----------|
| Sigla | Prezzo € |
| 8119 000 | € 201,00 |

Patty top
 Pattumiera con accesso dal top e
 sacchetto estraibile dall'alto dotata di
 coperchio in acciaio inox (capienza 13
 litri).

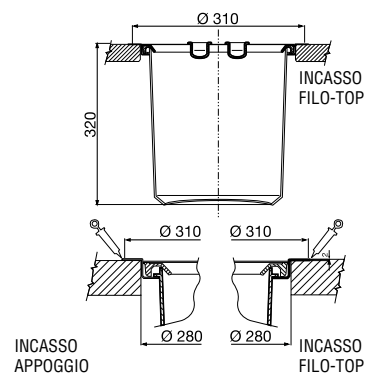



Complementi

Colonnine portaprese

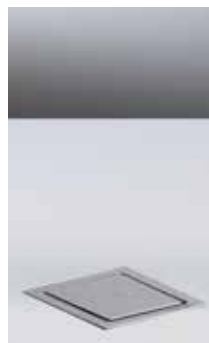

| Sigla | Prezzo € |
|----------|----------|
| 8000 016 | € 553,00 |

Totem Q-inox
Torretta portaprese estraibile
 - 2 prese Schuko
 - 1 presa ITA 3 poli 10A-16A
 - 1 presa USB per ricarica
 Cavo alimentazione in dotazione
 Con tappo inox finitura spazzolato Foster

Foro incasso: 96x108 mm, R max 5 mm
 Spessore top: max 50 mm

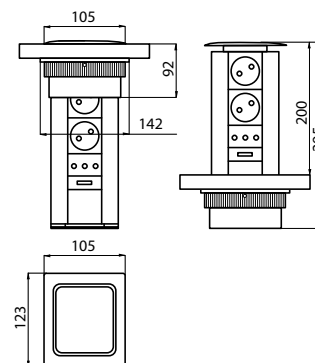

| Sigla | Prezzo € |
|----------|----------|
| 8000 011 | € 594,00 |

Totem4 inox
Torretta portaprese estraibile
 - 2 prese Schuko
 - 1 presa ITA 3 poli 10A-16A
 - 1 presa USB per ricarica
 Cavo alimentazione in dotazione
 Con tappo inox satinato

Foro incasso: ø102 mm
 Spessore top: max 50 mm

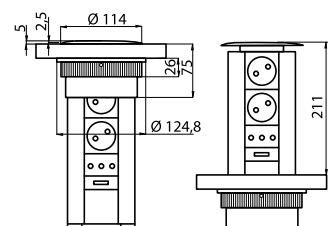

| Sigla | Prezzo € |
|----------|----------|
| 8000 012 | € 391,00 |

Totem3
Torretta portaprese estraibile
 - 2 prese Schuko
 - 1 presa ITA 3 poli 10A-16A
 Cavo alimentazione in dotazione
 Con tappo verniciato grigio

Foro incasso: ø102 mm
 Spessore top: max 50 mm

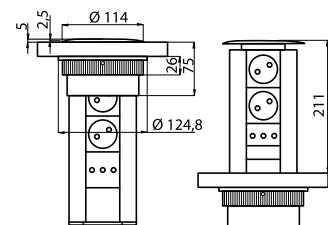

| Sigla | Prezzo € |
|----------|----------|
| 8000 014 | € 229,00 |

Casper
Torretta portaprese estraibile push
 - 2 prese Schuko
 Cavo alimentazione in dotazione

Foro incasso: ø80 mm
 Spessore top: max 60 mm

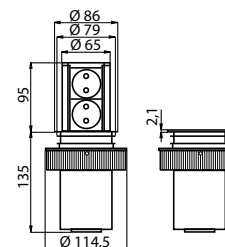



| Sigla | Prezzo € |
|----------|----------|
| 8000 214 | € 107,00 |



Kit per installazione a pensile

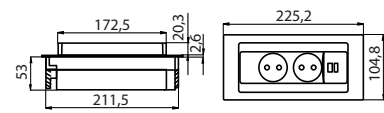

Complementi

Portaprese da incasso

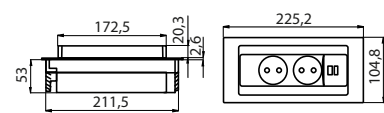
| | | | | | | | | | | | | |
|---|---|----------|-------|-------------------|----------|---------|----------|--|----------|----------|----------|---|
|  | <table border="0"> <tr> <td>Finitura</td> <td>Sigla</td> </tr> <tr> <td>spazzolato foster</td> <td>8000 010</td> </tr> <tr> <td>Vintage</td> <td>8000 117</td> </tr> </table> | Finitura | Sigla | spazzolato foster | 8000 010 | Vintage | 8000 117 | <table border="0"> <tr> <td>Prezzo €</td> </tr> <tr> <td>€ 474,00</td> </tr> <tr> <td>€ 448,00</td> </tr> </table> | Prezzo € | € 474,00 | € 448,00 |  |
| | Finitura | Sigla | | | | | | | | | | |
| spazzolato foster | 8000 010 | | | | | | | | | | | |
| Vintage | 8000 117 | | | | | | | | | | | |
| Prezzo € | | | | | | | | | | | | |
| € 474,00 | | | | | | | | | | | | |
| € 448,00 | | | | | | | | | | | | |
| <p>Reverse Slot portaprese push in acciaio inox per incasso su piani da lavoro - 2 prese Schuko - 1 presa USB per ricarica</p> <p>Foro incasso: 215x88 mm</p> |  | | | | | | | | | | | |

| | | | | | | | | | | | | | | | |
|---|---|----------|-------|-----------|----------|------|----------|--------|----------|---|----------|----------|----------|----------|---|
|  | <table border="0"> <tr> <td>Finitura</td> <td>Sigla</td> </tr> <tr> <td>Gun Metal</td> <td>8000 116</td> </tr> <tr> <td>Gold</td> <td>8000 119</td> </tr> <tr> <td>Copper</td> <td>8000 118</td> </tr> </table> | Finitura | Sigla | Gun Metal | 8000 116 | Gold | 8000 119 | Copper | 8000 118 | <table border="0"> <tr> <td>Prezzo €</td> </tr> <tr> <td>€ 528,00</td> </tr> <tr> <td>€ 528,00</td> </tr> <tr> <td>€ 528,00</td> </tr> </table> | Prezzo € | € 528,00 | € 528,00 | € 528,00 |  |
| | Finitura | Sigla | | | | | | | | | | | | | |
| Gun Metal | 8000 116 | | | | | | | | | | | | | | |
| Gold | 8000 119 | | | | | | | | | | | | | | |
| Copper | 8000 118 | | | | | | | | | | | | | | |
| Prezzo € | | | | | | | | | | | | | | | |
| € 528,00 | | | | | | | | | | | | | | | |
| € 528,00 | | | | | | | | | | | | | | | |
| € 528,00 | | | | | | | | | | | | | | | |
| <p>Reverse PVD Slot portaprese push in acciaio inox PVD per incasso su piani da lavoro - 2 prese Schuko - 1 presa USB per ricarica</p> <p>Foro incasso: 215x88 mm</p> |  | | | | | | | | | | | | | | |

Complementi



Sigla
8000 113

Prezzo €
€ 362,00

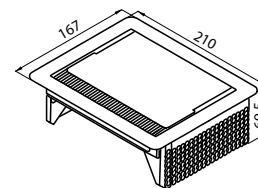

Filo3

Slot portaprese push per incasso su piani da lavoro

- 2 prese Schuko
- 1 presa ITA 3 poli 10A-16A
- Cavo alimentazione in dotazione

Foro incasso: 195x157 mm

Altezza massima del top 40 mm (per top di spessore superiore e per incasso filotop, vedere libretto istruzioni)



Sigla
8000 015

Prezzo €
€ 83,00

Cip

Portapresa per incasso su piani da lavoro

- 1 presa Schuko
- Cavo alimentazione in dotazione

Foro incasso: Ø 56 mm

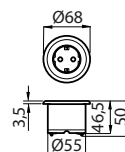

Accessori:

- 8000 215 kit copertura colore bianco € 17,00
- 8000 115 kit copertura colore grigio acciaio € 34,00
- 8000 315 kit copertura colore nero € 17,00



Sigla
8000 017

Prezzo €
€ 187,00

Cip-Cip

Slot portaprese da incasso con copripresa slide color grigio acciaio

- 2 prese Schuko
- Cavo alimentazione in dotazione

Accessori:

- 8000 217 kit copripresa colore bianco € 28,00
- 8000 317 kit copripresa colore nero € 28,00

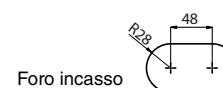
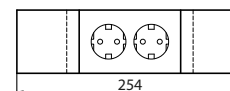
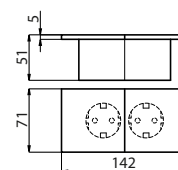

















































Foro incasso





Foster 

MISCELATORI

| | | | | | |
|-----------------------------|---|------------------------------------|---|------------------------------|---|
| Tube p. 160 |  | Master p. 172 |  | Omega Copper p. 182 |  |
| GK p. 162 |  | Gamma 3 vie p. 173 |  | Delta p. 183 |  |
| Play p. 163 |  | Eclipse p. 174 |  | Delta Plus p. 183 |  |
| Milanello p. 164 |  | NEW Flat p. 175 |  | KS p. 184 |  |
| Skin p. 165 |  | Arsenio p. 175 |  | NEW KS Plus p. 184 |  |
| Skin Gun Metal p. 166 |  | KE p. 176 |  | NEW Drop p. 185 |  |
| FL p. 167 |  | Gamma p. 176 |  | F2000 alto p. 185 |  |
| NEW |  | Lorenzo p. 177 |  | F2000 basso p. 186 |  |
| Magnum p. 168 |  | Luisa p. 177 |  | Beta p. 186 |  |
| Camillo p. 169 |  | Omega Plus p. 178 |  | Bite p. 187 |  |
| Flexo p. 169 |  | Omega Plus Gun Metal p. 179 |  | S1000 - Z65 p. 187 |  |
| 1/2 Circle p. 170 |  | Omega Plus Matt Black p. 179 |  | S1000 - Z85 p. 188 |  |
| NYC p. 170 |  | NEW |  | S1000 - RO p. 188 |  |
| Twix Plus p. 171 |  | Omega p. 180 |  | Dispenser p. 189 |  |
| Bert p. 171 |  | Omega Gun Metal p. 181 |  | | |
| Tre alto p. 172 |  | Omega Matt Black p. 181 |  | | |
| | | NEW |  | | |
| | | Omega Gold p. 182 |  | | |

Soluzioni speciali



Eclipse, Drop, Arsenio e Flat sono quattro miscelatori **ideali per le soluzioni “sotto-finestra”**: La canna, infatti, può essere facilmente abbassata fino a raggiungere un ingombro di pochi centimetri.



Il miscelatore **Magnum** è il modello **consigliato per l'uso professionale**. La canna flessibile consente di raggiungere ogni angolo del lavello e grazie al comando direttamente sulla doccetta si controlla agilmente il getto d'acqua.



GK, Play, Tube, Milanello, Skin e FL offrono una soluzione estetica particolare ed accattivante, con l'imponente arco che li caratterizza. La bocca del miscelatore può essere orientata ed il flusso d'acqua direzionato nei punti desiderati.



Il miscelatore **Gamma 3 Vie** permette l'erogazione di acqua calda/fredda e acqua filtrata per uso alimentare. Questo grazie ad un terzo condotto indipendente che può essere utilizzato in abbinamento ad un qualsiasi sistema di condizionamento dell'acqua.



Un aspetto tutto nuovo per i miscelatori **Omega, Omega Plus e Skin**, grazie all'innovativo trattamento fisico PVD (Physical Vapor Deposition). Questo permette la deposizione di metalli pregiati sulle superfici d'acciaio, conferendo un'esclusiva colorazione e migliorando la resistenza a graffi e usura. I miscelatori **Gun Metal, Gold e Copper** si abbinano perfettamente con le vasche KE nelle stesse colorazioni.





Caratteristiche

Foster offre una collezione di miscelatori completa e diversificata sia nell'estetica che nelle caratteristiche funzionali, capace di valorizzare al meglio la vasta gamma di lavelli. Le linee essenziali e moderne delle proposte a canna quadra si alternano alle versioni più tradizionali con estetiche morbide e sinuose. I comandi remoti e i dispenser, che trovate nella sezione Complementi Lavelli, riprendono in modo perfetto il design dei miscelatori, formando coordinati di alto pregio estetico.

Qualità nei materiali

I miscelatori Foster rispondono alle normative più rigorose. Materiali certificati a bassissimo contenuto di piombo, cartucce ceramiche e flessibili testati ad altissime pressioni garantiscono grande robustezza, un funzionamento sempre fluido e preciso e soprattutto la piena **sicurezza alimentare**.



Inox AISI 316

Soluzioni in acciaio inox AISI 316 satinato, che garantiscono una perfetta resistenza alla corrosione e la massima igiene e sicurezza, anche per acqua ad uso alimentare.



Rotazione canna

Tutti i miscelatori sono dotati di un ampio angolo di rotazione. Alcuni modelli permettono una rotazione completa di 360°.



Canna abbattibile

Caratteristica che rende possibile progettare la zona lavello davanti ad una finestra, potendo così godere della luce naturale.



Doppio flusso d'acqua

Molti modelli sono dotati di comando per cambiare agevolmente la modalità del getto d'acqua da flusso continuo a pioggia.

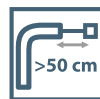

Doccetta estraibile

La bocca del miscelatore è estraibile per poter raggiungere agevolmente ogni zona del lavello.



Piastra di Rinforzo

Tutti i miscelatori Foster hanno in dotazione la piastra di rinforzo che fornisce perfetta stabilità su qualsiasi lavello.

Tube

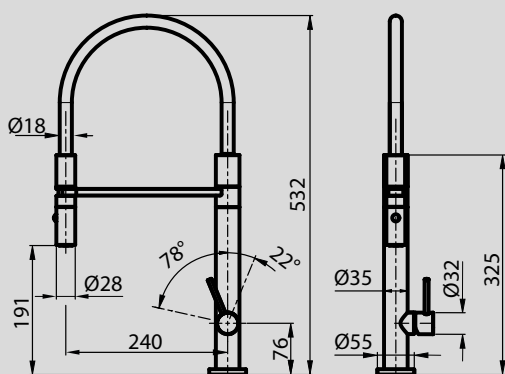

AISI
316



Miscelatore monocomando con canna girevole e doccia snodabile.
In acciaio inox AISI 316.

piastra di rinforzo inclusa
foro per miscelatore: \varnothing 35 mm
base d'appoggio: \varnothing 55 mm

angolo di rotazione: 360°
cartuccia con dischi ceramici
spessore max top: 40 mm

Sigla

8477 100
satinato/
nero

Prezzo €

€ 869,00



MISCELATORI

GK

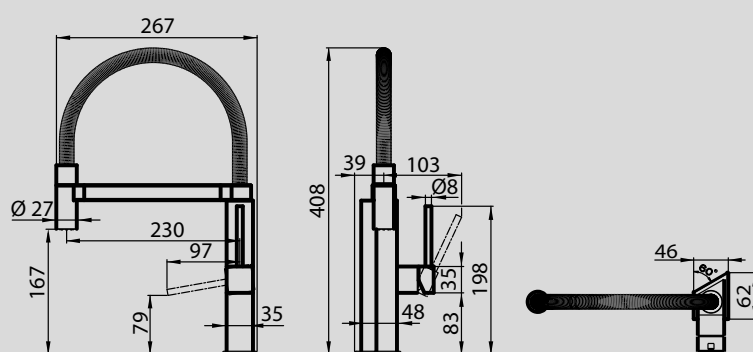

NOTA:
Miscelatore progettato per la serie di lavelli GK. La base del miscelatore GK ha forma irregolare.
Si raccomanda di verificare gli ingombri per abbinamento con altri lavelli.

Miscelatore monocomando con canna girevole e snodabile.

piastra di rinforzo inclusa
foro per miscelatore: \varnothing 35 mm
base d'appoggio: 62 x 46 mm

angolo di rotazione: 360°
cartuccia con dischi ceramici
spessore max top: 40 mm

Sigla
8488 000
cromato

Prezzo €
€ 934,00

Play

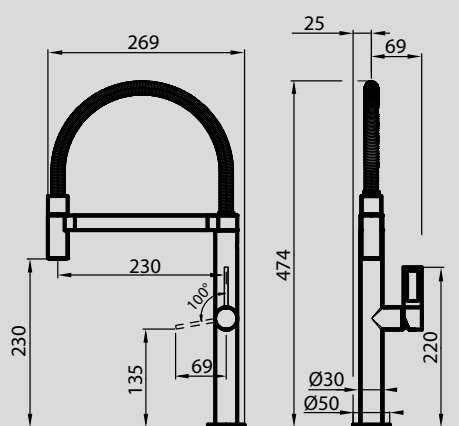
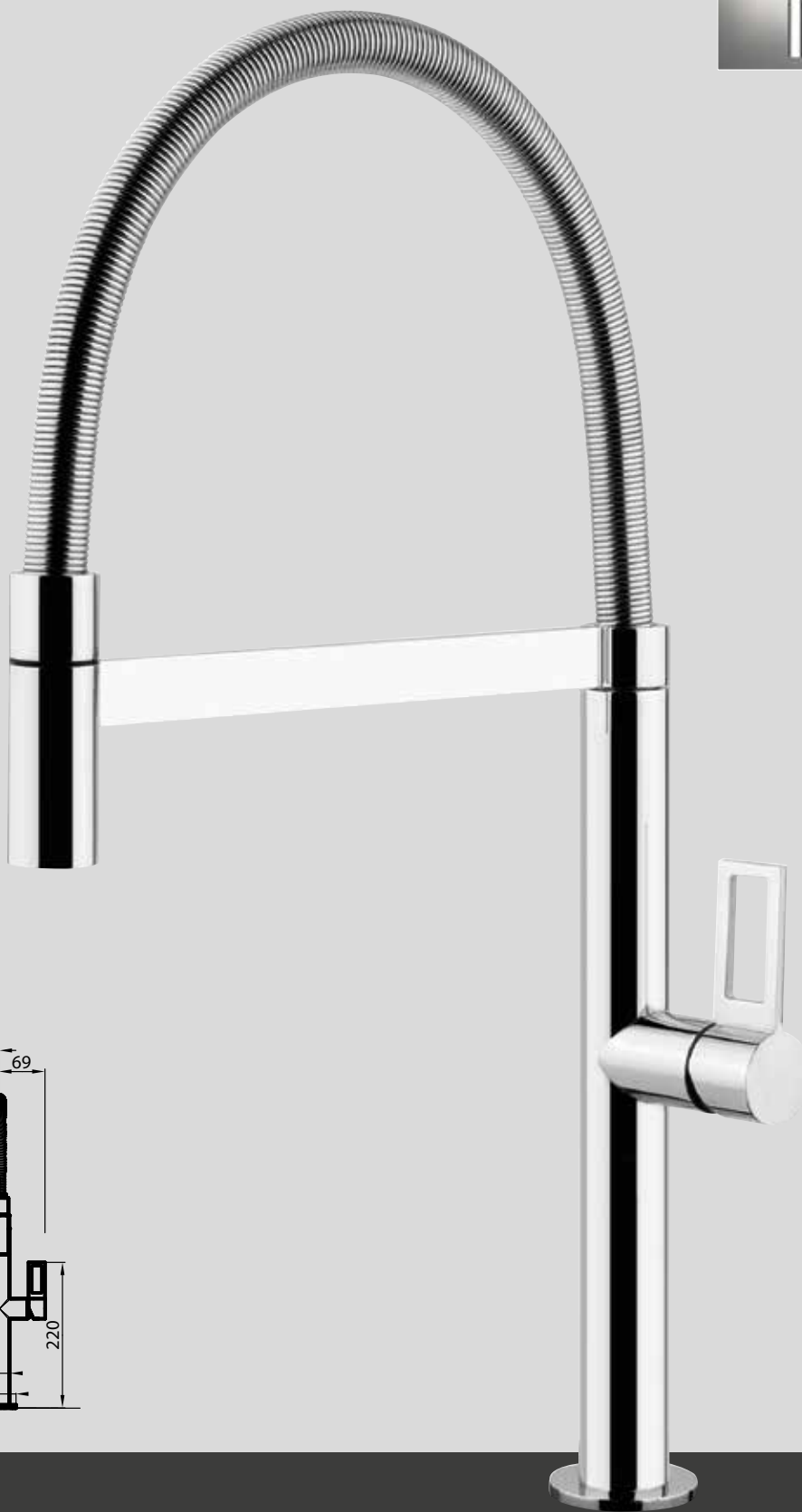

Miscelatore monocomando con canna girevole e snodabile.

piastra di rinforzo inclusa
foro per miscelatore: ø 35 mm
base d'appoggio: ø 50 mm

angolo di rotazione: 360°
cartuccia con dischi ceramici
spessore max top: 40 mm

Sigla
8487 000
cromato

Prezzo €
€ 678,00

Milanello

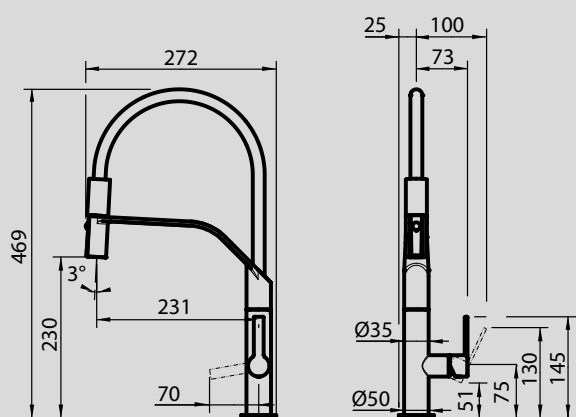

Miscelatore monocomando con canna girevole e doccia estraibile, con calza in acciaio inox.

piastra di rinforzo inclusa
foro per miscelatore: \varnothing 35 mm
base d'appoggio: \varnothing 50 mm

angolo di rotazione: 360°
cartuccia con dischi ceramici
spessore max top: 40 mm

Sigla
8425 100
satinato

Prezzo €
€ 707,00

Skin



Dettaglio della particolare trama del miscelatore Skin

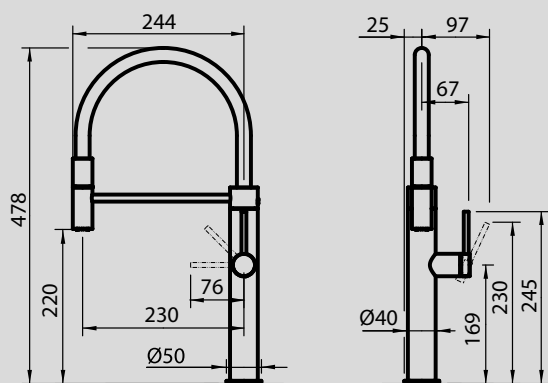
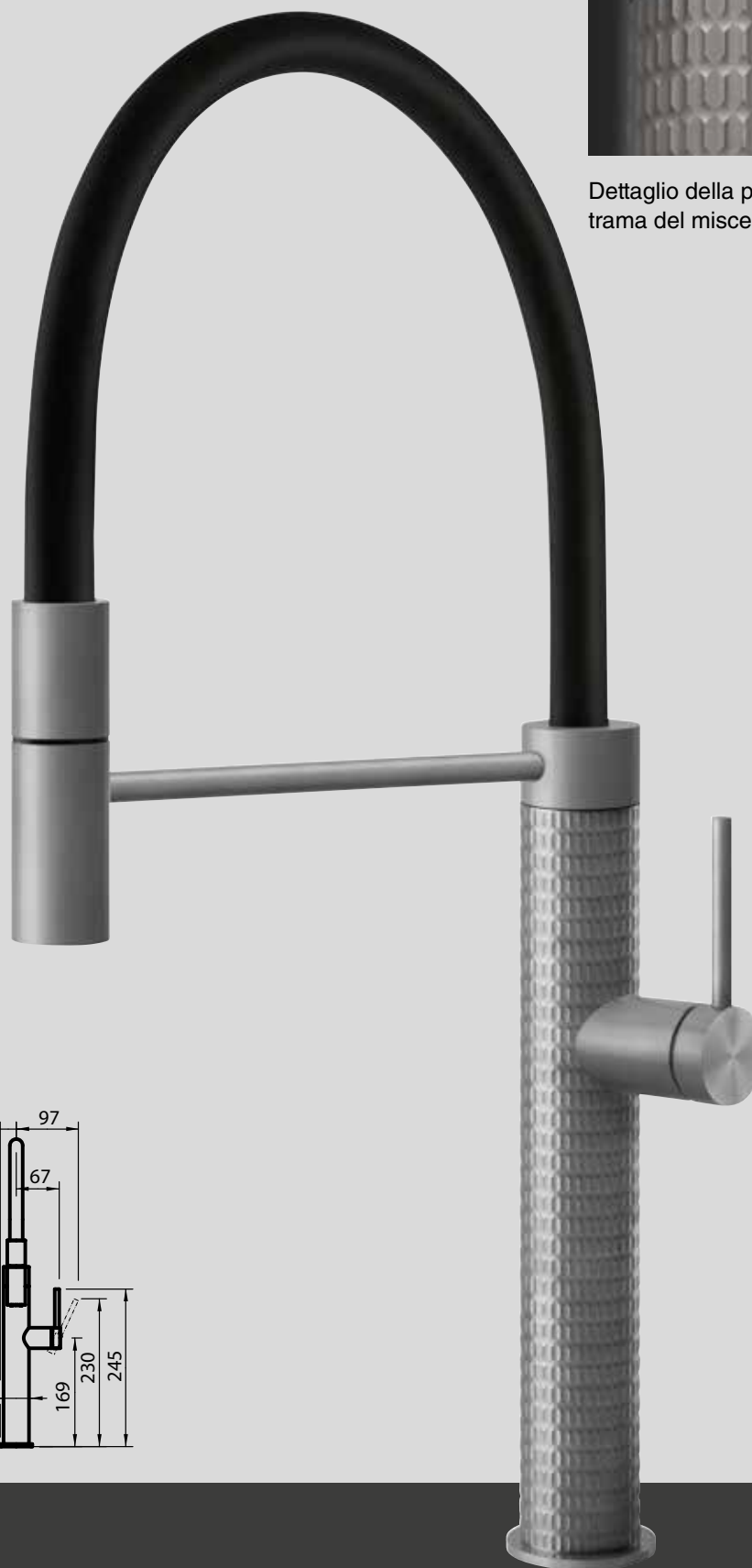

Miscelatore monocomando con canna girevole e doccia snodabile.

Parti estetiche in acciaio AISI 316
piastra di rinforzo inclusa
foro per miscelatore: \varnothing 35 mm
base d'appoggio: \varnothing 50 mm

angolo di rotazione: 360°
cartuccia con dischi ceramici
spessore max top: 40 mm

Sigla
8424 100
satinato

Prezzo €
€ 1.110,00

Skin Gun Metal

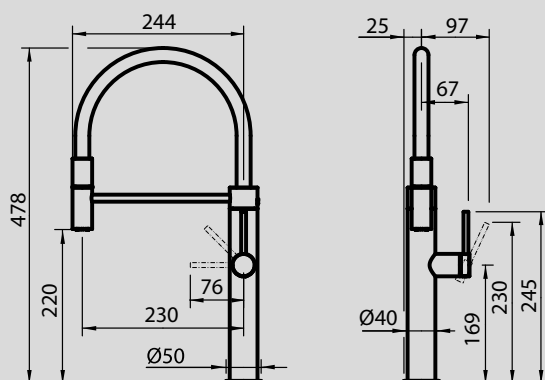

Miscelatore monocomando con trattamento PVD, con canna girevole e doccia snodabile.

Parti estetiche in acciaio AISI 316 con trattamento PVD
piastra di rinforzo inclusa
foro per miscelatore: \varnothing 35 mm

base d'appoggio: \varnothing 50 mm
angolo di rotazione: 360°
cartuccia con dischi ceramici
spessore max top: 40 mm

Sigla

8424 856
Gun Metal
Satinato

Prezzo €

€ 1.477,00

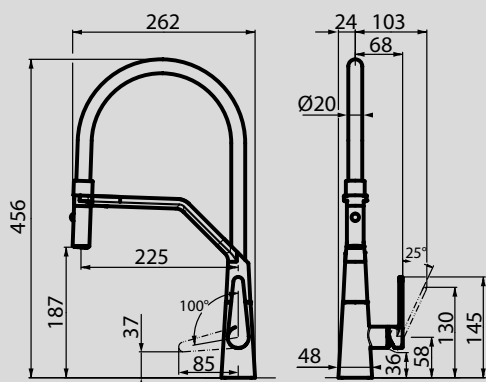
FL **NEW**

Miscelatore monocomando con canna girevole e doccia snodabile

Piastra di rinforzo inclusa
 Foro per miscelatore: $\varnothing 35$ mm
 base appoggio: 48x48 mm

angolo di rotazione 360°
 cartuccia con dischi ceramici
 spessore max top: 40 mm

Sigla
8521 000
 cromato/
 nero

Prezzo €
€ 518,00

Magnum

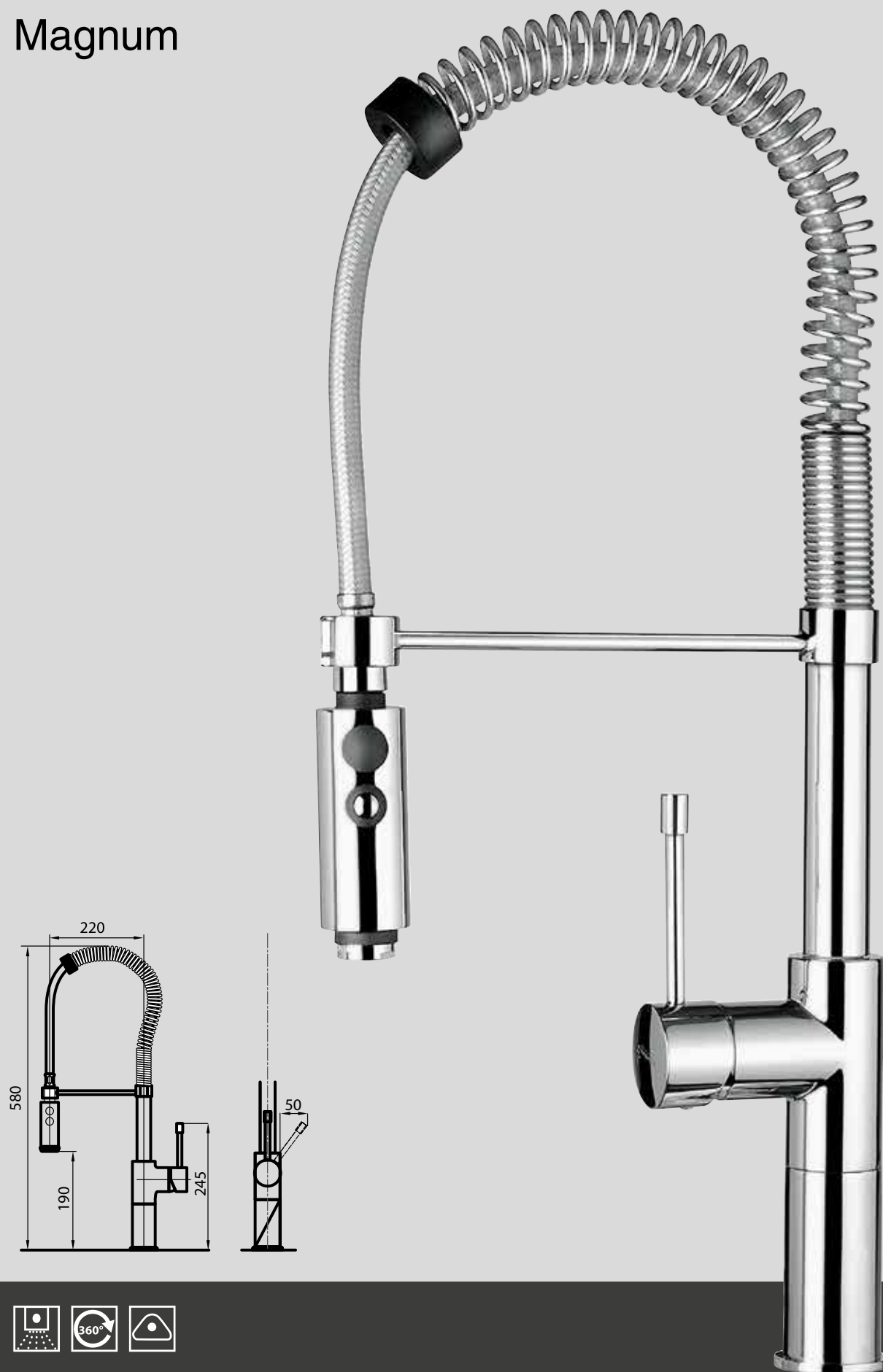

Miscelatore monocomando con canna girevole e doccia orientabile.

piastra di rinforzo inclusa
foro per miscelatore: \varnothing 35 mm
base d'appoggio: \varnothing 50 mm

angolo di rotazione: 360°
cartuccia con dischi ceramici
spessore max top: 50 mm

Sigla
8484 000
cromato

Prezzo €
€ 602,00

Camillo

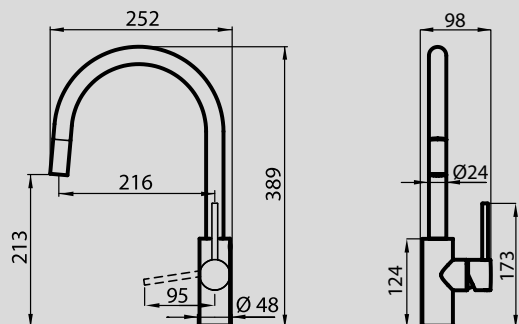

Miscelatore monocomando con canna girevole e bocca estraibile.

piastra di rinforzo inclusa
foro per miscelatore: \varnothing 35 mm
base d'appoggio: \varnothing 48 mm

angolo di rotazione: 170°
cartuccia con dischi ceramici
spessore max top: 40 mm

Sigla

8467 000
cromato

8467 100
satinato

Prezzo €

€ 525,00

€ 695,00

Flexo

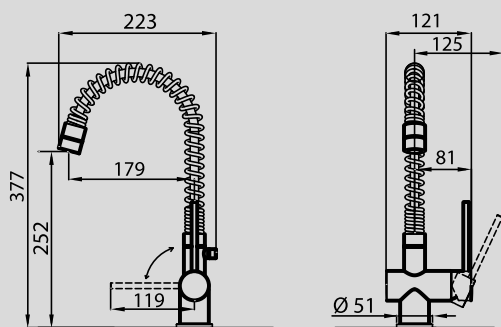

Miscelatore monocomando con canna girevole e bocca snodabile.

piastra di rinforzo inclusa
foro per miscelatore: \varnothing 35 mm
base d'appoggio: \varnothing 51 mm

angolo di rotazione: 360°
cartuccia con dischi ceramici
spessore max top: 40 mm

Sigla

8456 000
cromato

Prezzo €

€ 560,00

1/2 Circle

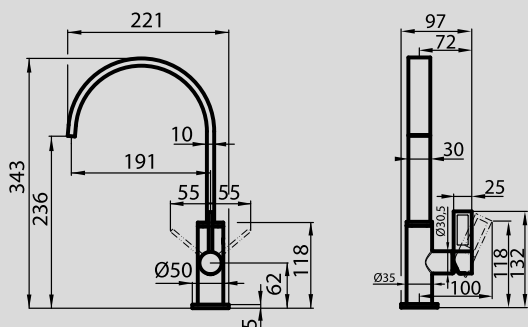

Miscelatore monocomando con canna girevole.

piastra di rinforzo inclusa
 foro per miscelatore: \varnothing 35 mm
 base d'appoggio: \varnothing 50 mm

angolo di rotazione: 360°
 cartuccia con dischi ceramici
 spessore max top: 40 mm

Sigla
8480 000
 cromato

Prezzo €
€ 416,00

NYC

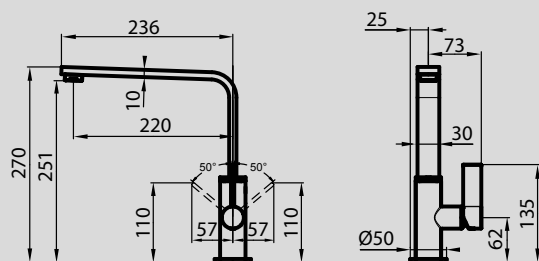

Miscelatore monocomando con canna girevole.

piastra di rinforzo inclusa
 foro per miscelatore: \varnothing 35 mm
 base d'appoggio: \varnothing 50 mm

angolo di rotazione: 360°
 cartuccia con dischi ceramici
 spessore max top: 40 mm

Sigla
8486 000
 cromato

Prezzo €
€ 446,00

Twix Plus

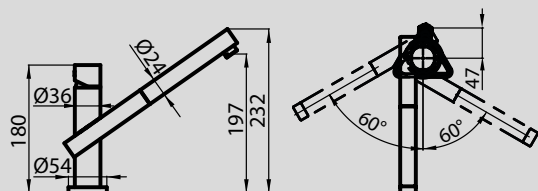

Miscelatore monocomando con canna girevole e bocca estraibile.

piastra di rinforzo inclusa
foro per miscelatore: \varnothing 35 mm
base d'appoggio: \varnothing 54 mm

angolo di rotazione: 120°
cartuccia con dischi ceramici
spessore max top: 50 mm

Sigla
8427 020
cromato

Prezzo €
€ 596,00

Bert

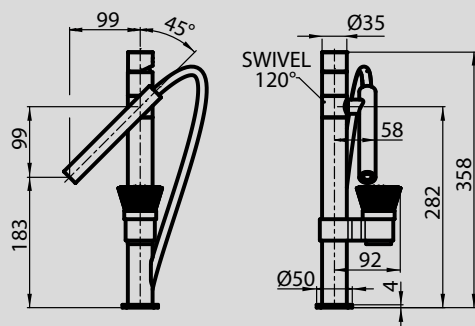

Miscelatore monocomando con doccia estraibile.
In acciaio inox AISI 316.

piastra di rinforzo inclusa
foro per miscelatore: \varnothing 35 mm
base d'appoggio: \varnothing 50 mm
angolo di rotazione: 120°

cartuccia con dischi ceramici
spessore max top: 50 mm
spazzola Hydrobrush in dotazione

Sigla
8428 100
satinato
inox

Prezzo €
€ 989,00

Tre Alto

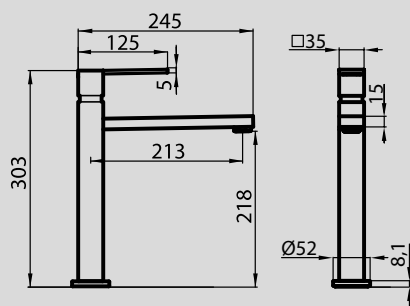

Miscelatore monocomando con canna girevole.

piastra di rinforzo inclusa
foro per miscelatore: ø 35 mm
base d'appoggio: ø 52 mm

angolo di rotazione: 120°
cartuccia con dischi ceramici
spessore max top: 40 mm

Sigla
8468 000
cromato

Prezzo €
€ 691,00

Master

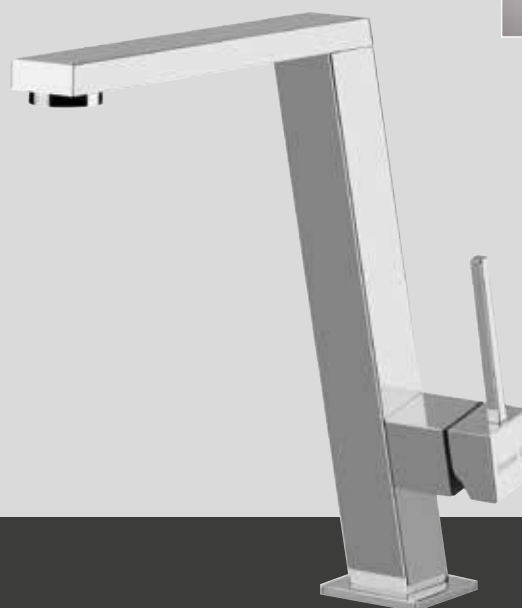
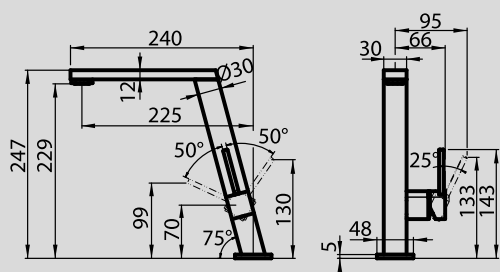

Miscelatore monocomando con canna girevole.

piastra di rinforzo inclusa
foro per miscelatore: ø 35 mm
base d'appoggio: 48x48 mm

angolo di rotazione: 360°
cartuccia con dischi ceramici
spessore max top: 40 mm

Sigla
8493 000
cromato

Prezzo €
€ 498,00

Gamma 3 vie

AISI 316

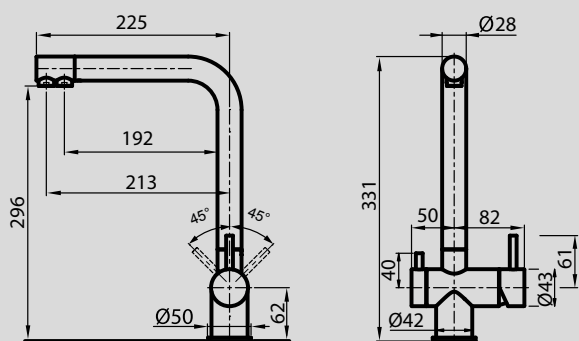

Miscelatore a tre vie con doppio comando e canna girevole.
Le tre vie permettono erogazione di acqua calda/fredda e filtrata per uso alimentare.

Miscelatore in acciaio inox
AISI 316 satinato
piastra di rinforzo inclusa
foro per miscelatore: \varnothing 35 mm

base d'appoggio: \varnothing 50 mm
angolo di rotazione: 360°
cartuccia con dischi ceramici
spessore max top: 50 mm

Sigla
8496 100
satinato
inox

Prezzo €
€ 633,00

Eclipse NEW

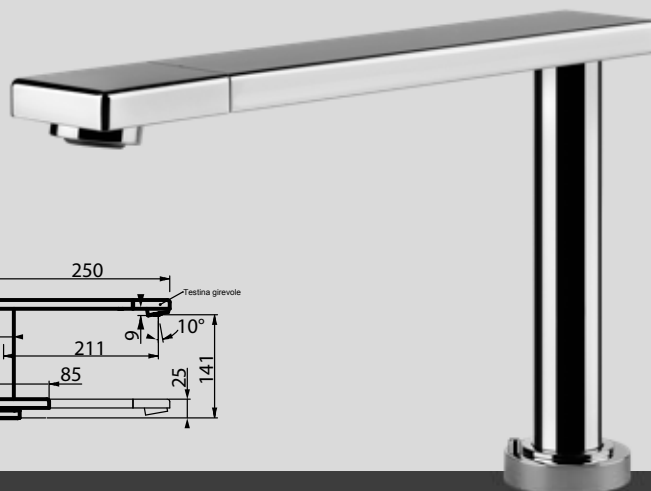
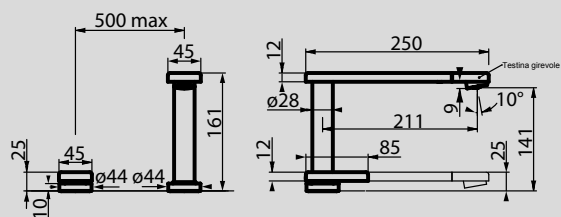

mixer abbattibile

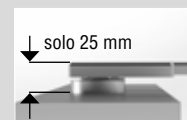

solo 25 mm
minimo ingombro

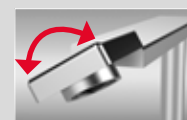

testina girevole



Miscelatore monocomando abbattibile con canna e testina girevoli.

cartuccia con dischi ceramici
spessore max top 40mm

ingombro posteriore massimo (per rotazione comando) 40mm dal centro del foro.

rotazione canna 360° - rotazione testina 60°
base appoggio ø44

piastra di rinforzo inclusa
foro per mix ø35

Sigla

8499 000
cromato

Prezzo €

€ 900,00

Interassi Mixer-Comando: con mixer a sx: min 260/max 500 mm - con mixer a dx: min 300/max 500 mm

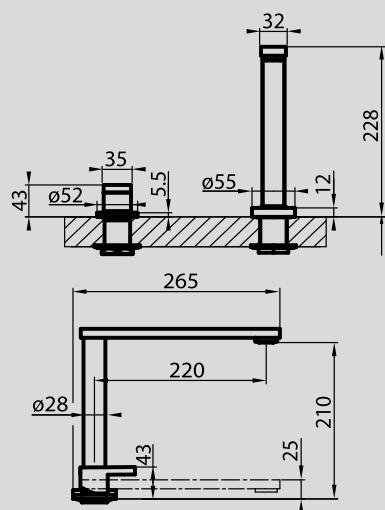

Flat **NEW**

mixer abbattibile



Miscelatore monocomando con canna girevole a scomparsa (Up&Down), con comando remoto (necessario doppio foro, max distanza fori 500 mm).

piastra di rinforzo inclusa
foro per miscelatore: \varnothing 35 mm
necessario doppio foro,
distanza fori: max 500 mm - min. 85 mm

base d'appoggio: \varnothing 55 mm
angolo di rotazione: 360°
cartuccia con dischi ceramici
spessore max top: 40 mm

Sigla

8478 001
cromato

Prezzo €

€ 656,00

Arsenio

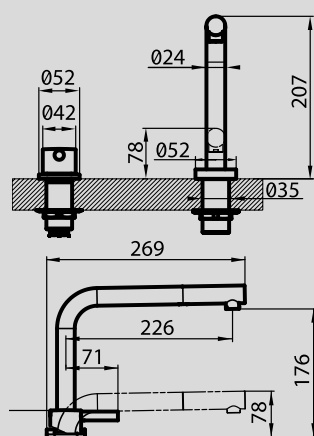

mixer abbattibile



Miscelatore monocomando con canna girevole a scomparsa (Up&Down), con bocca estraibile e comando remoto (necessario doppio foro, max distanza fori 500 mm).

piastra di rinforzo inclusa
foro per miscelatore: \varnothing 35 mm
necessario doppio foro,
distanza fori: max 500 mm - min. 85 mm

base d'appoggio: \varnothing 52 mm
angolo di rotazione: 360°
cartuccia con dischi ceramici
spessore max top: 40 mm

Sigla

8471 000
cromato

Prezzo €

€ 652,00

KE

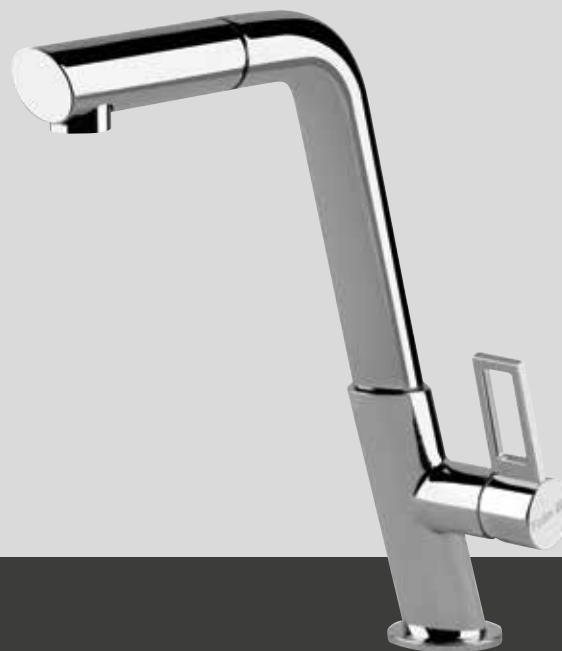
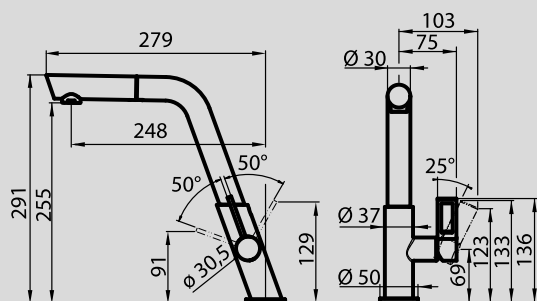

Miscelatore monocomando con canna girevole e bocca estraibile.

piastra di rinforzo inclusa
foro per miscelatore: $\varnothing 35$ mm
base d'appoggio: $\varnothing 50$ mm

angolo di rotazione: 360°
cartuccia con dischi ceramici
spessore max top: 40 mm

Sigla

8492 000
cromato

Prezzo €

€ 487,00

Gamma

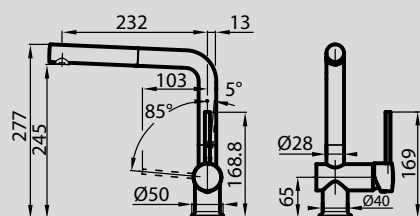

Miscelatore monocomando con canna girevole e bocca estraibile.

piastra di rinforzo inclusa
foro per miscelatore: $\varnothing 35$ mm
base d'appoggio: $\varnothing 50$ mm

angolo di rotazione: 180°
cartuccia con dischi ceramici
spessore max top: 30 mm

Sigla

8483 001
cromato

Prezzo €

€ 315,00

Lorenzo

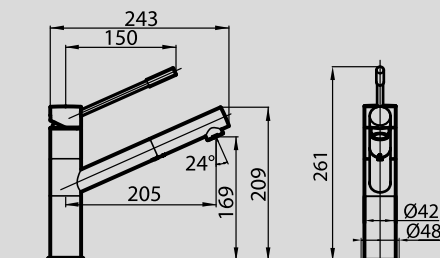

Miscelatore monocomando con canna girevole e bocca estraibile.

piastra di rinforzo inclusa
foro per miscelatore: \varnothing 35 mm
base d'appoggio: \varnothing 48 mm

angolo di rotazione: 120°
cartuccia con dischi ceramici
spessore max top: 40 mm

Sigla

8466 000
cromato

8466 100
satinato

Prezzo €

€ 385,00

€ 500,00

Luisa

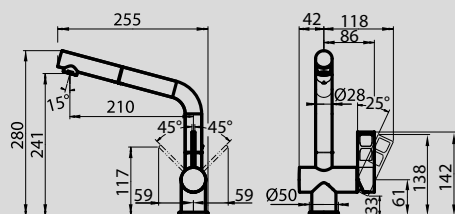

Miscelatore monocomando con canna girevole e bocca estraibile.

piastra di rinforzo inclusa
foro per miscelatore: \varnothing 35 mm
base d'appoggio: \varnothing 50 mm

angolo di rotazione: 360°
cartuccia con dischi ceramici
spessore max top: 40 mm

Sigla

8482 000
cromato

Prezzo €

€ 399,00

Omega Plus

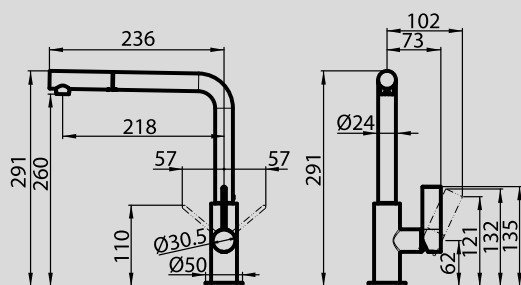
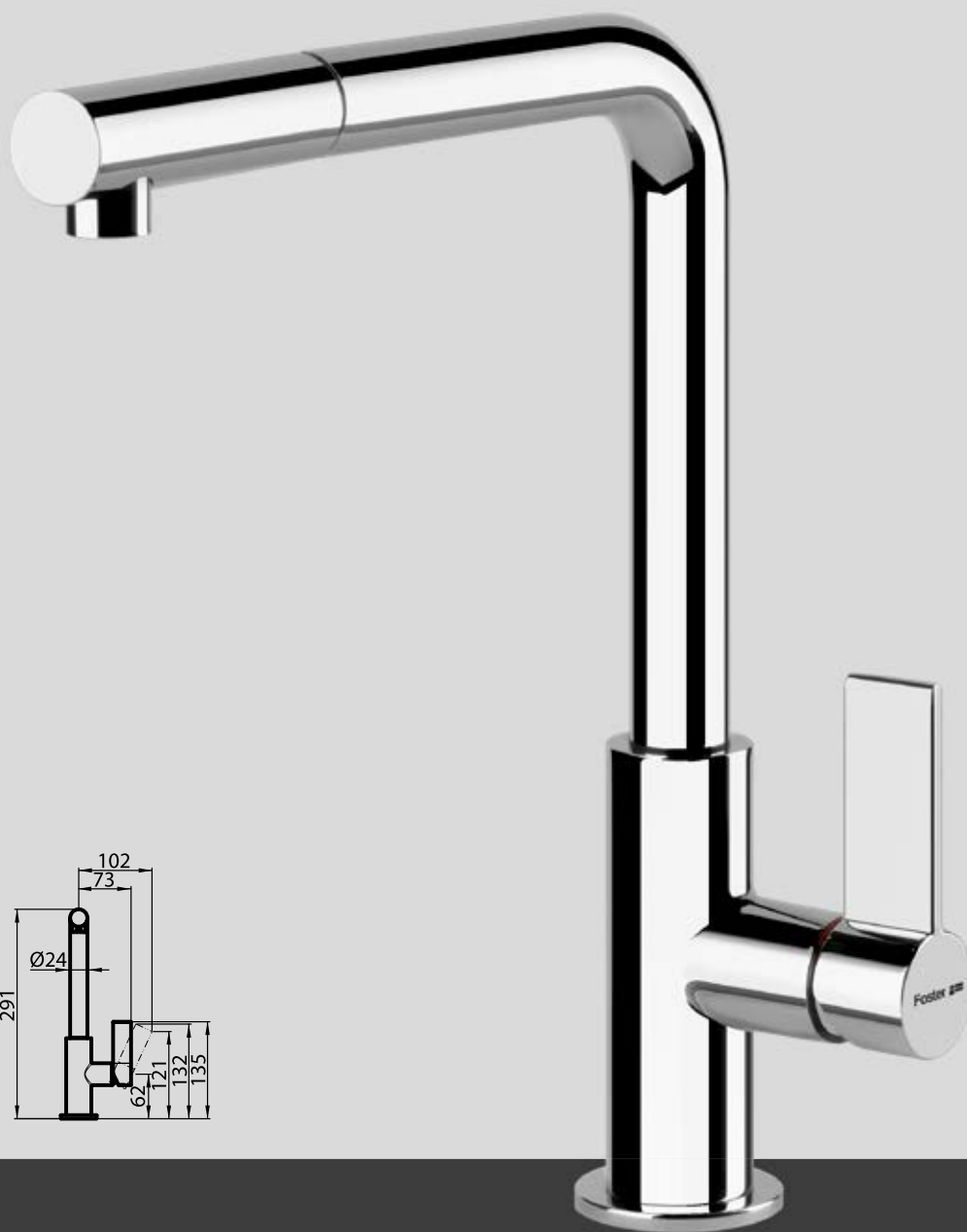

Miscelatore monocomando con canna girevole e bocca estraibile.

piastra di rinforzo inclusa
foro per miscelatore: \varnothing 35 mm
base d'appoggio: \varnothing 50 mm

angolo di rotazione: 360°
cartuccia con dischi ceramici
spessore max top: 40 mm

Sigla
8497 020
cromato

Prezzo €
€ 411,00

Omega Plus Gun metal

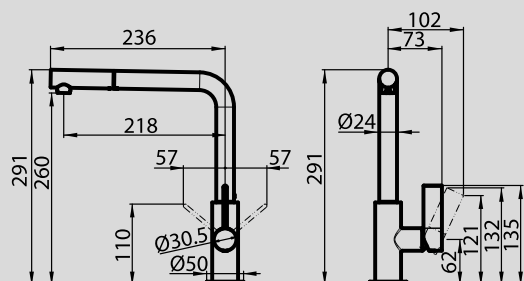

Miscelatore monocomando con trattamento PVD, con canna girevole e bocca estraibile.

piastra di rinforzo inclusa
foro per miscelatore: \varnothing 35 mm
base d'appoggio: \varnothing 50 mm

angolo di rotazione: 360°
cartuccia con dischi ceramici
spessore max top: 40 mm

Sigla

8498 856
gun metal

Prezzo €

€ 598,00

Omega Plus Matt Black NEW

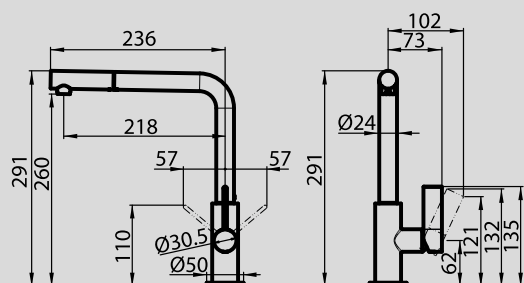

Miscelatore monocomando con canna girevole e bocca estraibile.

piastra di rinforzo inclusa
foro per miscelatore: \varnothing 35 mm
base d'appoggio: \varnothing 50 mm

angolo di rotazione: 360°
cartuccia con dischi ceramici
spessore max top: 40 mm

Sigla

8498 626
matt black

Prezzo €

€ 573,00

Omega

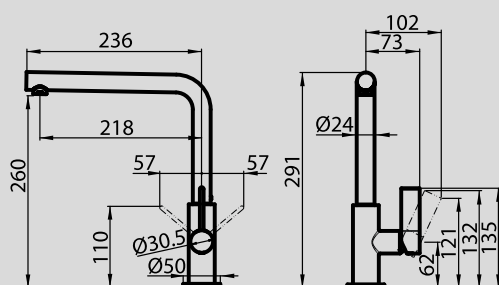
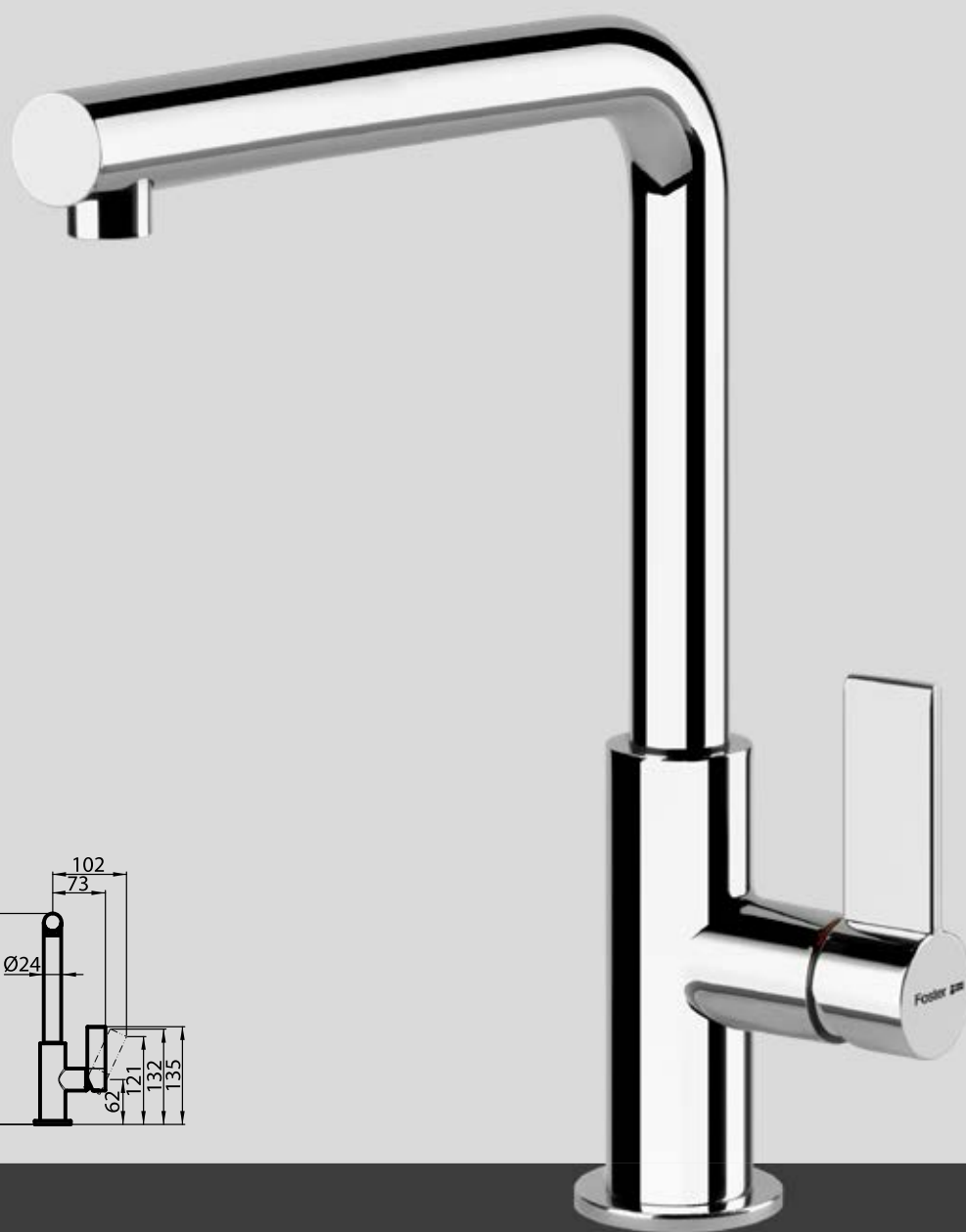

Miscelatore monocomando con canna girevole.

piastra di rinforzo inclusa
foro per miscelatore: \varnothing 35 mm
base d'appoggio: \varnothing 50 mm

angolo di rotazione: 360°
cartuccia con dischi ceramici
spessore max top: 40 mm

Sigla

8497 000
cromato

NEW

8497 100
satinato

Prezzo €

€ 296,00

€ 358,00

Omega Gun Metal

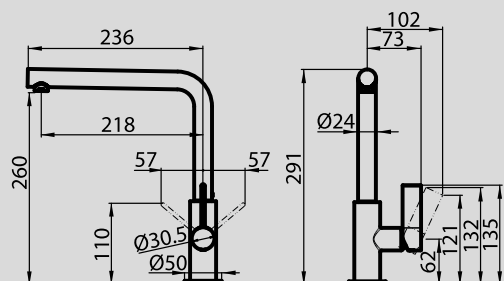

Miscelatore monocomando con trattamento PVD, con canna girevole.

piastra di rinforzo inclusa
foro per miscelatore: \varnothing 35 mm
base d'appoggio: \varnothing 50 mm

angolo di rotazione: 360°
cartuccia con dischi ceramici
spessore max top: 40 mm

Sigla

8497 856
gun metal

Prezzo €

€ 472,00

Omega Matt Black NEW

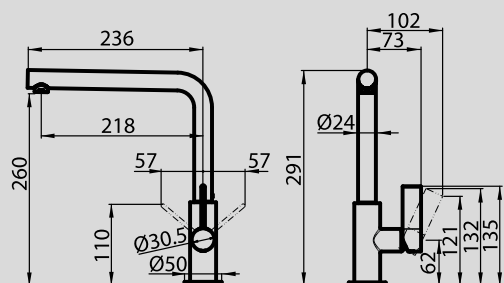

Miscelatore monocomando, con canna girevole.

piastra di rinforzo inclusa
foro per miscelatore: \varnothing 35 mm
base d'appoggio: \varnothing 50 mm

angolo di rotazione: 360°
cartuccia con dischi ceramici
spessore max top: 40 mm

Sigla

8497 606
matt black

Prezzo €

€ 373,00

Omega Gold

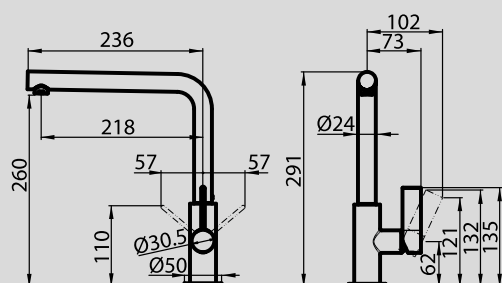

Miscelatore monocomando con trattamento PVD, con canna girevole.

piastra di rinforzo inclusa
foro per miscelatore: \varnothing 35 mm
base d'appoggio: \varnothing 50 mm

angolo di rotazione: 360°
cartuccia con dischi ceramici
spessore max top: 40 mm

Sigla
8497 700
gold

Prezzo €
€ 572,00

Omega Copper

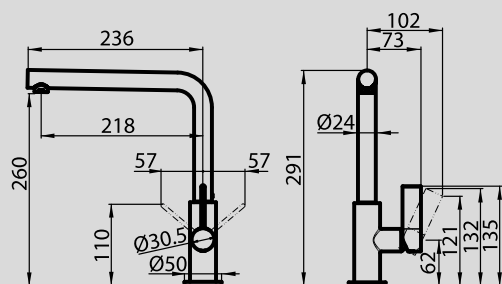

Miscelatore monocomando con trattamento PVD, con canna girevole.

piastra di rinforzo inclusa
foro per miscelatore: \varnothing 35 mm
base d'appoggio: \varnothing 50 mm

angolo di rotazione: 360°
cartuccia con dischi ceramici
spessore max top: 40 mm

Sigla
8497 400
copper

Prezzo €
€ 572,00

Delta

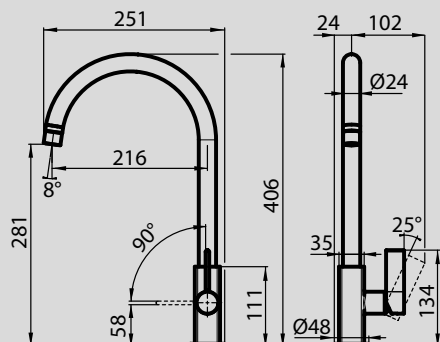

Miscelatore monocomando con canna girevole.

piastra di rinforzo inclusa
foro per miscelatore: \varnothing 35 mm
base d'appoggio: \varnothing 48 mm

angolo di rotazione: 360°
cartuccia con dischi ceramici
spessore max top: 40 mm

Sigla
8441 000
cromato

Prezzo €
€ 247,00

Delta Plus

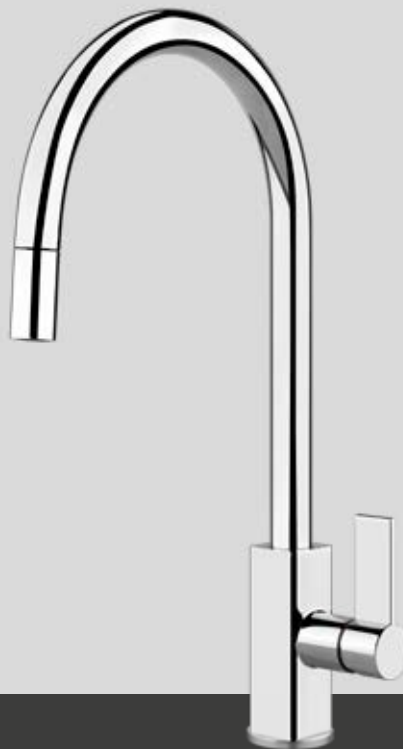
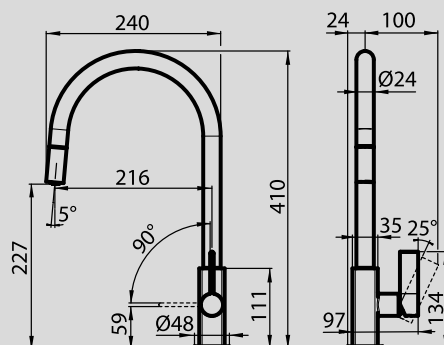

Miscelatore monocomando con canna girevole e bocca estraibile.

piastra di rinforzo inclusa
foro per miscelatore: \varnothing 35 mm
base d'appoggio: \varnothing 48 mm

angolo di rotazione: 360°
cartuccia con dischi ceramici
spessore max top: 40 mm

Sigla
8441 030
cromato

Prezzo €
€ 348,00

KS **NEW**

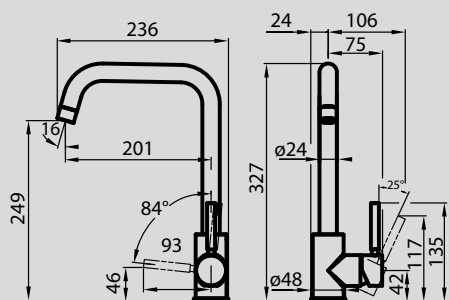

Miscelatore monocomando con canna girevole.

piastra di rinforzo inclusa
foro per miscelatore: \varnothing 35 mm
base d'appoggio: \varnothing 48 mm

angolo di rotazione: 360°
cartuccia con dischi ceramici
spessore max top: 40 mm

Sigla
8485 002
cromato

Prezzo €
€ 261,00

KS Plus **NEW**

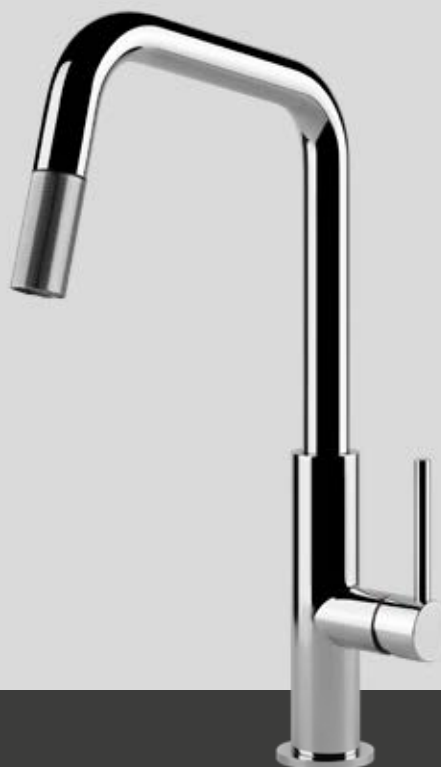
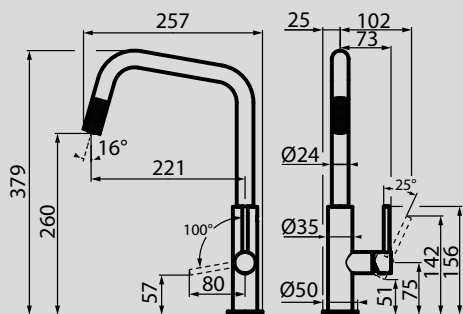

miscelatore monocomando con canna girevole e bocca estraibile

Piastra di rinforzo inclusa
Foro per miscelatore: \varnothing 35 mm
base appoggio: \varnothing 50 mm

angolo di rotazione 360°
cartuccia con dischi ceramici
spessore max top: 40 mm

Sigla
8522 000
cromato

8522 100
satinato

Prezzo €
€ 374,00

€ 460,00

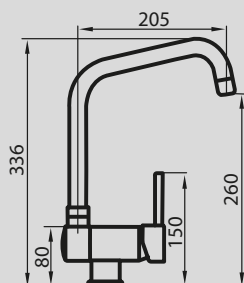
Drop **NEW**

miscelatore monocomando con canna girevole e abbattibile

Piastra di rinforzo inclusa
 Foro per miscelatore: $\varnothing 35$ mm
 base appoggio: $\varnothing 48$ mm

angolo di rotazione 360°
 cartuccia con dischi ceramici
 spessore max top: 65 mm

Sigla

8523 000
 cromato

Prezzo €

€ 271,00

F2000 - Alto

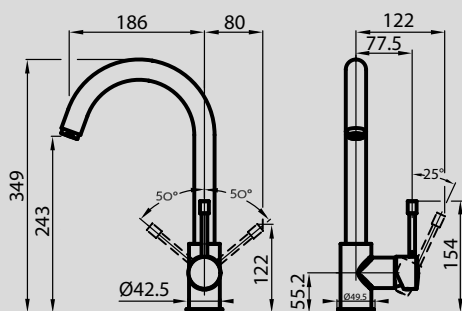

Miscelatore monocomando con canna girevole.

piastra di rinforzo inclusa
 foro per miscelatore: $\varnothing 35$ mm
 base d'appoggio: $\varnothing 50$ mm

angolo di rotazione: 360°
 cartuccia con dischi ceramici
 spessore max top: 50 mm

Sigla

8458 000
 cromato

Prezzo €

€ 217,00

F2000 - Basso

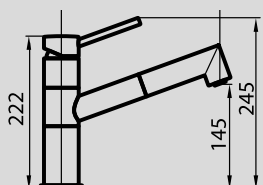

Miscelatore monocomando con canna girevole e doccia estraibile.

piastra di rinforzo inclusa
foro per miscelatore: \varnothing 35 mm
base d'appoggio: \varnothing 60 mm

angolo di rotazione: 180°
cartuccia con dischi ceramici
spessore max top: 50 mm

Sigla
8459 000
cromato

Prezzo €
€ 339,00

Beta

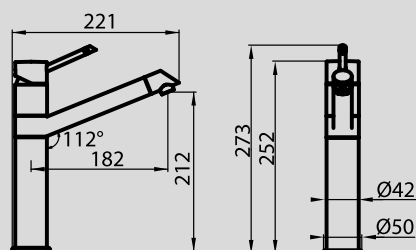

Miscelatore monocomando con canna girevole.

piastra di rinforzo inclusa
foro per miscelatore: \varnothing 35 mm
base d'appoggio: \varnothing 50 mm

angolo di rotazione: 360°
cartuccia con dischi ceramici
spessore max top: 40 mm

Sigla
8490 000
cromato

Prezzo €
€ 300,00

Bite

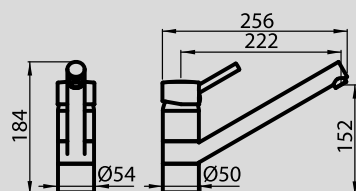

Miscelatore monocomando con canna girevole.

piastra di rinforzo inclusa
foro per miscelatore: \varnothing 35 mm
base d'appoggio: \varnothing 54 mm
angolo di rotazione: 360°

cartuccia con dischi ceramici
spessore max top: 40 mm
ingombro posteriore per
rotazione comando: 15 mm

Sigla

8481 000
cromato

Prezzo €

€ 198,00

S1000 - Z65

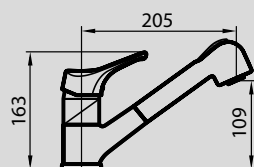

Miscelatore monocomando con canna girevole e doccia estraibile.

piastra di rinforzo inclusa
foro per miscelatore: \varnothing 35 mm
base d'appoggio: \varnothing 55 mm

angolo di rotazione: 180°
cartuccia con dischi ceramici
spessore max top: 40 mm

Sigla

8449 500
cromato

Prezzo €

€ 201,00

S1000 - Z85

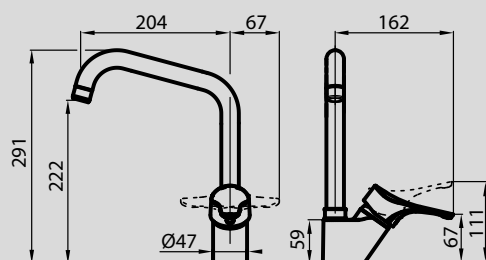

Miscelatore monocomando con canna girevole.

piastra di rinforzo inclusa
foro per miscelatore: \varnothing 35 mm
base d'appoggio: \varnothing 48 mm

angolo di rotazione: 360°
cartuccia con dischi ceramici
spessore max top: 40 mm

Sigla
8442 500
cromato

Prezzo €
€ 140,00

S1000 - RO

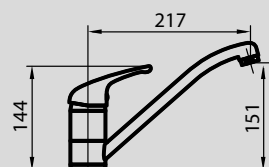

Miscelatore monocomando con canna girevole.

piastra di rinforzo inclusa
foro per miscelatore: \varnothing 35 mm
base d'appoggio: \varnothing 50 mm

angolo di rotazione: 360°
cartuccia con dischi ceramici
spessore max top: 40 mm

Sigla
8443 002
cromato

Prezzo €
€ 105,00



Dispenser



Dispenser Quadra

Distributore da incasso in metallo cromato per detersivo/sapone liquido

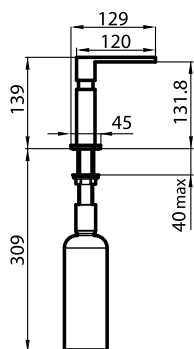

Sigla
8520 000

Prezzo €
€ 350,00



Dispenser Round

Distributore da incasso in acciaio cromato per detersivo/sapone liquido

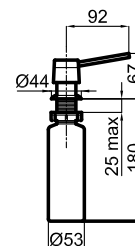

Sigla
8530 000

Prezzo €
€ 71,00



Dispenser Evo

Distributore da incasso per detersivo/sapone liquido

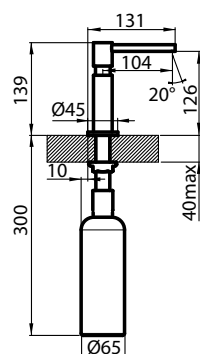

Sigla
8520 010
cromato
8520 100
satinato

Prezzo €
€ 209,00
€ 272,00



Dispenser Evo Gun Metal*

Distributore da incasso per detersivo/sapone liquido

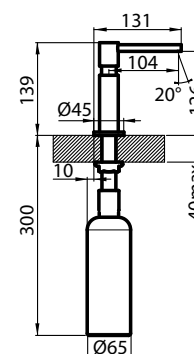

Sigla
8520 856
gun metal

Prezzo €
€ 306,00

* Gun metal lucido realizzato su finitura cromata, si abbina ai miscelatori Omega gun metal.



Foster
INDUSTRIUM



△ × 4 + i + 0 4 +
- + - +
⊖ ⊕ ⚙ + 6 ⊖ 0 +

PIANI INDUZIONE

Il design nella tecnologia



Foster Milano Air
p. 196



S4000 Induction Bridge
p. 198



S4000 con Power Control
p. 199



S4000 Induction
p. 200



S4000 Domino
p. 201



KE Induction
p. 204



S1000 Induction
p. 206



Modular Induction
p. 208



Modular Quadra Induction
p. 212



Collezione pentole
Induction Pro
p. 195



PIANI
INDUZIONE

I vantaggi della cottura ad induzione



Controllo

Grande versatilità e un controllo preciso e puntuale sono caratteristiche peculiari dell'induzione. I nove settaggi di potenza (con in aggiunta le opzioni Powerboost) offrono un grande spettro di possibilità, che vanno dal mantenimento di calore fino ad una potenza netta disponibile impensabile con altri sistemi.



Sicurezza

Il piano viene riscaldato solo dalla pentola e non raggiunge mai temperature ustionanti; togliendo il recipiente si interrompe il funzionamento. La sicurezza è garantita dai sistemi di Riconoscimento pentola, Overflow detector, Disattivazione automatica e Blocco di sicurezza.



Pulizia

La zona di cottura si attiva solo sul fondo della pentola ed attorno il piano resta freddo, così se i cibi fuoriescono non bruciano e non provocano spiacevoli incrostazioni difficili da togliere. La pulizia è pertanto molto semplice e veloce e l'igiene perfetta.

Risparmio energetico



Grazie alla grande velocità nel portare i liquidi in ebollizione e all'efficienza nettamente superiore a tutti gli altri sistemi di cottura, l'induzione comporta un notevole risparmio energetico.

Esempi di assorbimenti per tipologie di cottura

| livelli cottura | potenza | tipo cottura | esempi di utilizzo |
|-----------------|---------------|-----------------|------------------------|
| 1-2 | 50-130 W | molto dolce | fusione, bagnomaria |
| 3-4 | 150-300 W | dolce | riscaldare, sobbollire |
| 5-7 | 350-750 W | media | sughi, riso |
| 7-9 | 1.000-2.300 W | vivace | arrostiture, friggere |
| Powerboost | 1.400-3.000 W | riduzione tempi | ebollizione liquidi |

L'elevata potenza di cui sono dotati i piani a induzione Foster porta a pensare ad un grande impegno di energia. Come si può vedere in tabella, la maggior parte delle cotture richiede, al contrario, potenze ridotte.

Tipologie di incasso

I modelli ad induzione possono essere installati sia in appoggio che con lavorazione a filo, creando un ribasso nel top.



Incassi per piani con bordo bisellato.

Bordo bisellato

Bordo inclinato (bisellato) che dona un'estetica pulita ed elegante e si abbina perfettamente con i lavelli Semifilo.



Incassi per piani con bordo verticale.

Bordo verticale

Incasso con bordo di forma squadrata che sporge di soli 4 mm sul piano di lavoro.

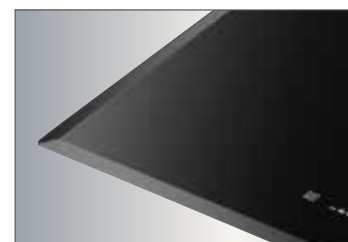

Nuova tecnologia Bridge



Cottura su zona estesa

La funzione Bridge permette di associare due zone formando un'unica estesa zona di cottura, disponibile per pentole di grandi dimensioni o per più cotture in contemporanea. superficie estesa.

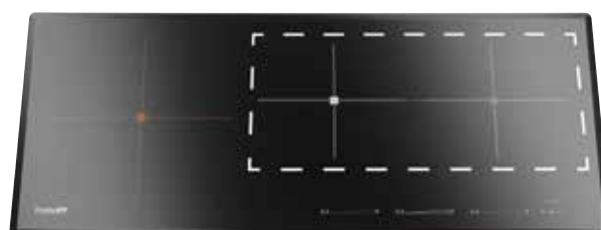

Caratteristiche della tecnologia Bridge di Foster

L'innovativa forma rettangolare delle piastre induttive Bridge permette la massima efficienza sull'intera zona di cottura. Permette di dosare l'intera potenza sulle singole piastre o su tutta la superficie, e migliori performance con pentole di ogni dimensione. L'attivazione è intuitiva e immediata, l'intera zona viene quindi gestita con un singolo comando Slider.

Piani con limitazione PowerControl



PowerControl

Consente di utilizzare in libertà la tecnologia ad induzione anche nel caso di utenze standard da 3 kW. L'utente può facilmente modificare il massimo assorbimento del piano, da un minimo di 2,8 kW alla soluzione "non limitata". Potremo dimenticarci degli assorbimenti e il piano penserà ad avvisarci di eventuali limiti lasciandoci poi la scelta di ripartire la potenza come meglio desideriamo. In qualsiasi momento il piano può essere facilmente riprogrammato per modificare o togliere il limite di potenza.

Un controllo da vero Chef



T-chef

Permette di impostare particolari temperature (42 °C, 70 °C, 94 °C) e mantenerle costanti durante la cottura. Si possono così facilmente ottenere preparazioni elaborate con risultati da vero Chef. Lavorazioni a bagno-maria, creme pasticciere o besciamella saranno sempre perfette. Impostando la temperatura prossima all'ebollizione i liquidi di cottura saranno in temperatura quando servono, aumentando velocità e performance.



Powerboost

I piani ad induzione Foster sono dotati della funzione Booster [P], che garantisce un aumento di potenza alla piastra selezionata. In particolare, quando viene attivato il Booster, la piastra funziona per dieci minuti ad una potenza molto elevata che permette di riscaldare rapidamente grandi quantità d'acqua.

| Quantità | Senza Powerboost | Con Powerboost |
|----------|------------------|----------------|
| 3 litri | 5 min. | 3 min. |
| 5 litri | 8 min. | 5 min. |

Tempi indicativi per portare ad ebollizione con e senza Powerboost



Funzionamento comando Slider

L'impostazione della temperatura prescelta è rapidissima con il comando Slider: è sufficiente sfiorare con un dito il display TOUCH sul livello di potenza desiderata.

Sicurezza

Tutti i piani sono dotati delle più moderne e sofisticate protezioni: **Spegnimento centralizzato**; **Blocco per la sicurezza**; **Indicatori di calore residuo**; **Safety System** che spegne il piano in mancanza di pentole; **Overflow detector**, che spegne la piastra in caso di tracimazione di liquidi; **Disattivazione automatica**, per scongiurare incidenti causati da dimenticanze.

Pot Speed Test **NEW**

Testa le vostre pentole, restituendo una classificazione da 0 a 3 in funzione dell'efficienza e velocità di riscaldamento.

Pausa

Utile funzione che permette di distogliere l'attenzione dalle vostre cotture, interrompendo e ripristinando le modalità impostate in modo istantaneo.

Mantenimento calore

Permette di mantenere in temperatura (70° C) le vostre pietanze in modo delicato, senza raggiungere temperature di ebollizione o capaci di bruciare il fondo di cottura.

Intelligent Pot Localization **NEW**

Riconosce su quale zona viene appoggiata la pentola e attiva automaticamente i relativi comandi per la regolazione della potenza.



Double Powerboost

Sui nuovi modelli S4000 è presente l'ulteriore funzione Doppio Booster: due ulteriori regolazioni di potenza che raggiungono i 3700 W, utilizzabili su una singola zona o distribuiti sull'intera zona estesa del Bridge (dove presente).



Programmazione fine cottura

Tutte le operazioni vengono impostate tramite comandi touch-control sul cristallo del piano. Ogni piastra è dotata di programmazione indipendente che permette di impostare differenti tempi di cottura.

Contaminuti

Su alcuni modelli è disponibile un ulteriore timer contaminuti svincolato dalla programmazione di fine cottura.

Pot Detector

I piani Foster non solo riconoscono la presenza delle pentole, ma ne calcolano la superficie d'appoggio. Questo sistema permette un utilizzo di energia ancora più efficiente. Rimuovendo la pentola, inoltre, le piastre si disattivano automaticamente.

Smart Fan System

La corretta ventilazione è essenziale per il funzionamento ottimale dei piani ad induzione. Il sistema Foster regola automaticamente il grado di ventilazione in funzione delle temperature raggiunte.

Automatismo Go&Stop

Attiva le piastre inizialmente alla massima potenza, fino al raggiungimento del livello impostato.

Automatic Bridge **NEW**

Quando una pentola invade 2 differenti zone, attiva automaticamente la funzione Bridge.

Recall

La funzione permette di richiamare in modo immediato le ultime impostazioni selezionate nella precedente cottura.

Collezione pentole Induction PRO

MASSIME PRESTAZIONI PER LA VOSTRA INDUZIONE



Batteria pentole Induction PRO 8 pz.

| | |
|----------|----------|
| Sigla | Prezzo € |
| 8210 008 | € 408,00 |

In acciaio inox 18/10
 Triplo fondo acciaio/alluminio/acciaio,
 termosaldato con tecnologia Impact Bonding
 Maniglie professionali 6 punti di saldatura
 Lavabili in lavastoviglie

- 1 Pentola Ø cm 24
- 1 Casseruola fonda 2 maniglie Ø cm 20
- 1 Casseruola fonda 2 maniglie Ø cm 24
- 1 Casseruola fonda 1 manico Ø cm 16
- 1 Tegame 2 maniglie Ø cm 24
- 1 Bollilatte 1 manico Ø cm 12
- 1 Coperchio vetro Ø cm 20
- 1 Coperchio vetro Ø cm 24



Padella wok con fondo piatto Induction PRO



In acciaio inox 18/10 - Ø 30 cm
 Triplo fondo acciaio/alluminio/acciaio,
 termosaldato con tecnologia Impact Bonding
 Lavabile in lavastoviglie

Bistecchiera Induction PRO



In alluminio rivestito in Teflon DuPont Platinum plus
 fondo termofuso Alluminio-acciaio - 30x30 cm
 Manico in bachelite
 Lavabile in lavastoviglie

Foster Milano Air

LA FORZA DI FUOCO E ARIA ASSIEME, IN CLASSE A++

A++
CLASS



Sei velocità di aspirazione

Sei velocità e una portata fino a 680 mc/h sono la garanzia di una aspirazione potente ed efficace in ogni situazione.



Raccolta acqua di trabocco

La vasca di contenimento sotto la griglia permette la raccolta di liquidi di trabocco fino ad 1,5 litri.



Superficie liscia

Milano Air è complanare, anche nella zona di aspirazione. Le pentole possono scorrere in sicurezza su tutto il piano.



Facile accesso ai filtri

La forma ergonomica della griglia permette un facile accesso ai filtri e alla vasca di raccolta per la pulizia.



Doppia zona Bridge

Foster Milano Air ha due ampie zone di cottura estese, che possono essere attivate tramite la funzione Bridge.



Controllo intuitivo

Il funzionale pannello touch comanda in modo semplice e immediato le zone di cottura e la funzione di aspirazione.



| | | |
|----|----------|------------|
| SF | 7391 245 | € 3.304,00 |
| FT | 7391 245 | |

Semifilo: 860x530 - foro: 810x500 mm
 Filotop: 860x530 - foro: vedi sito web

| | |
|-------------------------|-----------------------------|
| P. max assorbita | 3.000, 4.000, 7.400** W |
| 2 zone anteriori | Ø 160 mm - 1.200 (1.600)* W |
| 2 zone posteriori | Ø 200 mm - 2.300 (3.000)* W |
| 2 zone estese Bridge | 3.700 W |

* Powerboost



alimentazione:
 mono-fase 230V-1P+N
 bi-fase 400V-2P+N
 frequenza 50±60 Hz

**con la funzione PowerControl, la potenza max può essere impostata in utenza ai valori riportati

Piano cottura ad induzione con cappa aspirante integrata

Finitura:
 Vetroceramica nero

Caratteristiche induzione:

programmazione elettronica;
 doppia funzione Bridge;
funzione PowerControl
 9 settaggi di potenza per zona
 più funzione Powerboost;
 comandi touch control;
 pot detector;
 dotazioni di sicurezza.

Caratteristiche aspirazione:

Funzionamento aspirante;
 programmazione elettronica;
 6 velocità di aspirazione (4 + 2 intensive);
 2 filtri antigrasso lavabili;
 spegnimento ritardato automatico;
 avvisi di saturazione filtri antigrasso e carbone;
 funzionamento filtrante opzionale con filtri carbone.
 Portata: 680 m³/h - motore EBM
Classe energetica: A++

Accessori:

- cod. 9700 529 - filtro carbone sottogriglia rigenerabile* - € 101,00
 - cod. 9700 539 - mascherina da zoccolo - € 107,00
 - cod. 9700 574 - filtro professional** per zoccolo da 100/150 mm - € 458,00
 - cod. 9700 575 - ricarica per filtro zoccolo - € 267,00
- elementi di canalizzazione sotto-zoccolo non compresi - vedi pag. 271

* Il filtro carbone è rigenerabile una volta con lavaggio in lavastoviglie, raddoppiando così la sua durata.

** Il filtro professional è rigenerabile più volte

Nota: canale conduzione uscita aria e griglia uscita aria per zoccolo cucina disponibili su richiesta.

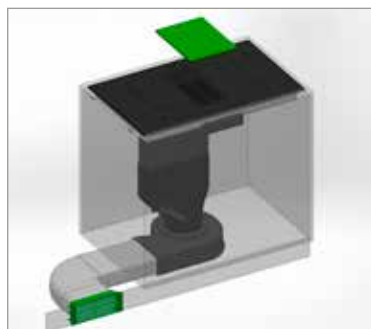
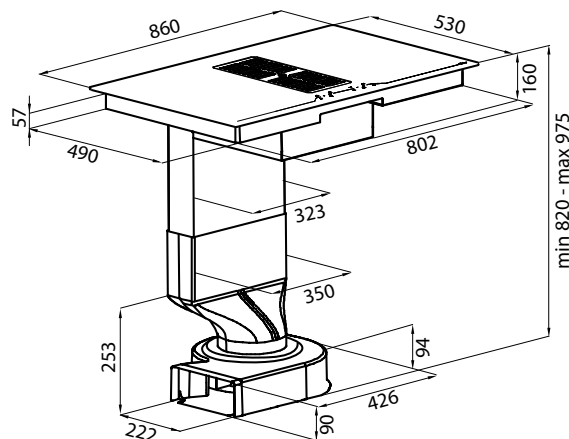

Allestimento filtrante con filtro carbone sottogriglia (9700529) e mascherina da zoccolo (9700539).

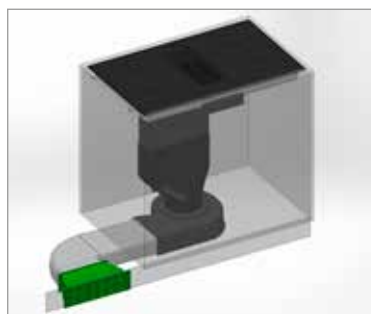

Allestimento filtrante con filtro da zoccolo (9700574).



Minimo ingombro

L'installazione del piano Foster Milano Air è semplice e versatile.

Le geometrie della cappa lasciano abbondante spazio nel sottopiano con la possibilità di usufruire di due ampi cassettoni.

Il motore, che risiede a terra sotto la base del cabinet, può essere ruotato per facilitare il deflusso dell'aria nella direzione più opportuna.

S4000 Induction Bridge

LA FUNZIONALITÀ DI UNA ZONA ESTESA DI COTTURA



| Caratteristiche | Versione | Sigla | Prezzo € | Disegno Tecnico |
|-----------------|----------|-------|----------|-----------------|
|-----------------|----------|-------|----------|-----------------|

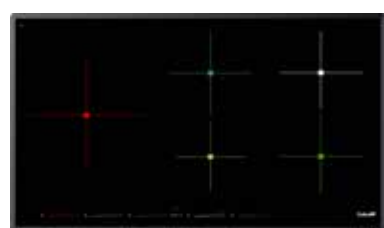

alimentazione:
mono-fase 230V-1P+N
bi-fase 400V-2P+N
frequenza 50÷60 Hz

Piano cottura a induzione
Finitura: Vetroceramica nero
programmazione elettronica;
funzione Bridge;
9 settaggi di potenza per zona più
funzione Powerboost;
comandi touch control;
comandi Slider;
funzione T-Chef;
automatismo go&stop;
pausa; recall;
dotazioni di sicurezza

| | |
|----|----------|
| SF | 7390 245 |
| FT | 7390 245 |

€ 2.239,00

P. max assorbita 11.100 W**
sinistra Ø 260 mm-2.600 (3.700)* W
centro sup. Ø 180 mm-1.850 (3.000)* W
centro inf. Ø 145 mm-1.400 (2.200)* W
destra: 2x220x180 mm-2.100 (3.700)* W

* Powerboost



Semifilo: 900x520 - foro: 880x490
Filotop: 900x520 - foro: vedi sito web

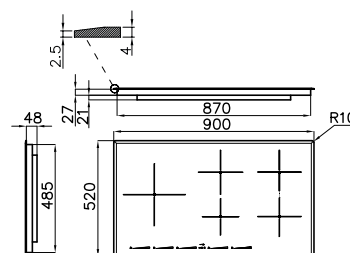

**il corretto funzionamento del piano cottura prevede un'utenza di almeno 7 kW di potenza.



alimentazione:
mono-fase 230V-1P+N
bi-fase 400V-2P+N
frequenza 50÷60 Hz

Piano cottura a induzione
Finitura: Vetroceramica nero
programmazione elettronica;
funzione Bridge;
9 settaggi di potenza per zona più
funzione Powerboost;
comandi touch control;
comandi Slider;
funzione T-Chef;
automatismo go&stop;
pausa; recall;
dotazioni di sicurezza

| | |
|----|----------|
| SF | 7334 245 |
| FT | 7334 245 |

€ 2.032,00

P. max assorbita 7.400 W
sinistra 180x220 mm-2.100 (3.700)* W
sinistra centro 180x220 mm-2.100 (3.700)* W
destra centro 180x220 mm-2.100 (3.700)* W
destra 180x220 mm-2.100 (3.700)* W

* Powerboost



Semifilo: 900x400 - foro: 870x370
Filotop: 900x400 - foro: vedi sito web

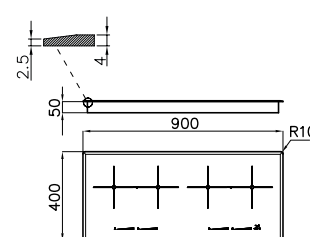

NEW



alimentazione:
mono-fase 230V-1P+N
bi-fase 400V-2P+N
frequenza 50÷60 Hz

Piano cottura a induzione
Finitura: Vetroceramica nero
programmazione elettronica;
funzione Bridge;
9 settaggi di potenza per zona più
doppio Powerboost;
Pot Speed Test;
comandi touch control;
Intelligent Pot Localization;
Automatic Bridge;
comandi Slider;
funzione T-Chef;
automatismo go&stop;
pausa; recall;
dotazioni di sicurezza

| | |
|----|----------|
| SF | 7330 255 |
| FT | 7330 255 |

€ 1.842,00

P. max assorbita 7.400 W
sinistra Ø 260 mm-2.600 (3.600)* (3.700)** W
centro 180x220 mm-2.100 (2.600)* (3.700)** W
destra 180x220 mm-2.100 (2.600)* (3.700)** W

* Powerboost - **Doppio Powerboost



Semifilo: 840x350 - foro: 810x330
Filotop: 840x350 - foro: vedi sito web

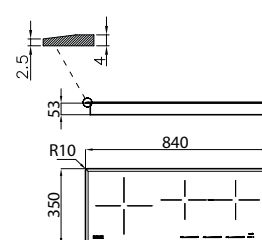

S4000 Induction con Power Control

PERFORMANCE A POTENZA CONTROLLATA



| Caratteristiche | Versione | Sigla | Prezzo € | Disegno Tecnico |
|-----------------|----------|-------|----------|-----------------|
|-----------------|----------|-------|----------|-----------------|



Piano cottura a induzione
 Finitura: Vetroceramica nero
funzione PowerControl
 programmazione elettronica;
 9 settaggi di potenza per zona più
 funzione Powerboost;
 comando slider;
 comandi touch control;
 pausa;
 dotazioni di sicurezza

| | |
|----|----------|
| SF | 7330 241 |
| FT | 7330 241 |

€ 1.467,00

P. max assorbita 6.600 W**

| | |
|----------|---------------------------|
| sinistra | Ø 240 mm-2.200 (3.000)* W |
| centro | Ø 145 mm-1.200 (1.600)* W |
| destra | Ø 210 mm-1.500 (2.000)* W |



Semifilo: 840x350 - foro: 810x330
 Filotop: 840x350 - foro: vedi sito web

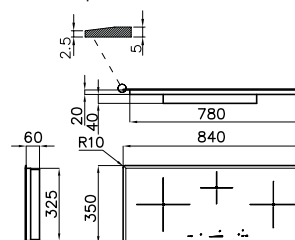

**con la funzione PowerControl, la potenza massima può essere impostata in utenza ai seguenti valori: 2.800 W, 3.500 W, 6.000 W, 6.600 W

alimentazione:
 mono-fase 230V~1P+N
 bi-fase 400V~2P+N
 frequenza 50÷60 Hz

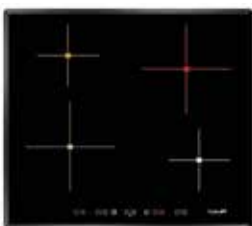

Piano cottura a induzione
 Finitura: Vetroceramica nero
funzione PowerControl
 programmazione elettronica;
 9 settaggi di potenza per zona più
 funzione Powerboost;
 comandi touch control;
 pausa;
 dotazioni di sicurezza

| | |
|----|----------|
| SF | 7372 241 |
| FT | 7372 241 |

€ 1.233,00

P. max assorbita 2.800, 3.500, 6.000, 7.200 W**

| | |
|---------------|---------------------------|
| sinistra | Ø 210 mm-1.500 (2.000)* W |
| sinistra sup. | Ø 145 mm-1.200 (1.600)* W |
| destra | Ø 145 mm-1.200 (1.600)* W |
| destra sup. | Ø 210 mm-1.500 (2.000)* W |



Semifilo: 590x520 - foro: 560x490
 Filotop: 590x520 - foro: vedi sito web

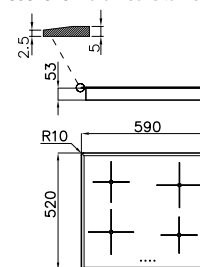

**con la funzione PowerControl, la potenza massima può essere impostata in utenza ai seguenti valori: 2.800 W, 3.500 W, 6.000 W, 6.600 W

alimentazione:
 mono-fase 230V~1P+N
 bi-fase 400V~2P+N
 frequenza 50÷60 Hz

PIANI INDUZIONE

S4000 Induction

UN'ICONA DI STILE



Caratteristiche | Versione | Sigla | Prezzo € | Disegno Tecnico



Piano cottura a induzione

Finitura:
Vetroceramica nero

programmazione elettronica;
9 settaggi di potenza per zona più doppio Powerboost; comandi touch control; timer indipendente; dotazioni di sicurezza

alimentazione:
mono-fase 230V~1P+N
bi-fase 400V~2P+N
frequenza 50÷60 Hz

SF 7334 240

FT 7334 240

€ 2.225,00

P. max assorbita 7.400 W

sinistra Ø 210 mm-2.050 (2.500)* (3.700)** W
sinistra centro Ø 210 mm-2.050 (2.500)* (3.700)** W
destra centro Ø 180 mm-1.850 (2.300)* (3.000)** W
destra Ø 180 mm-1.850 (2.300)* (3.000)** W

* Powerboost - **Doppio Powerboost



Semifilo: 1100x350 - foro: 1065x325
Filotop: 1100x350 - foro: vedi sito web

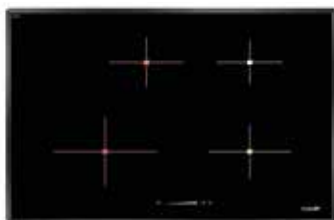
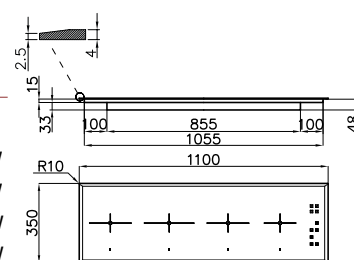

Articolo ad esaurimento

alimentazione:
mono-fase 230V~1P+N
bi-fase 400V~2P+N
frequenza 50÷60 Hz

Piano cottura a induzione

Finitura:
Vetroceramica nero

programmazione elettronica;
9 settaggi di potenza per zona più Powerboost; comandi touch control; comando Slider; funz. go&stop; pausa; recall; mantenimento temperatura; timer indipendente; dotazioni di sicurezza

SF 7332 240

FT 7332 240

€ 1.637,00

P. max assorbita 7.400 W

sinistra Ø 250 mm-2.300 (3.000)* W
centro Ø 180 mm-1.200 (1.400)* W
destra Ø 220 mm-2.300 (3.000)* W
destra sup. Ø 160 mm-1.200 (1.400)* W

* Powerboost



Semifilo: 800x520 - foro: 650x490
Filotop: 800x520 - foro: vedi sito web

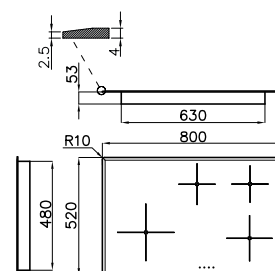

S4000 Domino

COMPOSIZIONI MODULATE SULLE VOSTRE ESIGENZE



| Caratteristiche | Versione | Sigla | Prezzo € | Disegno Tecnico |
|-----------------|----------|-------|----------|-----------------|
|-----------------|----------|-------|----------|-----------------|

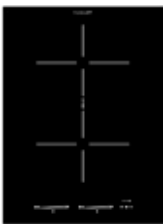



NEW



alimentazione:
mono-fase 230V~1P+N
frequenza 50÷60 Hz

Piano cottura a induzione

| | | |
|---|----------|-------------------|
|  | 7341 655 | € 1.150,00 |
|  | 7341 655 | |

Finitura: Vetroceramica nero

programmazione elettronica; funzione Automatic Bridge; Pot Speed test; 9 settaggi di potenza per zona più doppio Powerboost; comandi touch control; 2 comandi Slider per le singole zone; funzione T-Chef; intelligent pot localization; pausa; recall; timer indipendente; dotazioni di sicurezza Accessori: distanziere (v. pag. 203)

P. max assorbita 3.700 W
2 zone con funzione Bridge
180x220 mm-2.100 (2.600)* (3.700)** W
* Powerboost - **Doppio Powerboost



Semifilo: 380x520 - foro: 350x490
Filotop: 380x520 - foro: vedi sito web

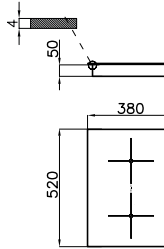

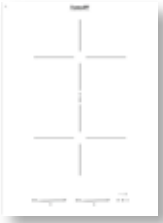



NEW



alimentazione:
mono-fase 230V~1P+N
frequenza 50÷60 Hz

Piano cottura a induzione

| | | |
|---|----------|-------------------|
|  | 7341 255 | € 1.263,00 |
|  | 7341 255 | |

Finitura: Vetroceramica bianco

programmazione elettronica; funzione Automatic Bridge; Pot Speed test; 9 settaggi di potenza per zona più doppio Powerboost; comandi touch control; 2 comandi Slider per le singole zone; funzione T-Chef; intelligent pot localization; pausa; recall; timer indipendente; dotazioni di sicurezza Accessori: distanziere (v. pag. 203)

P. max assorbita 3.700 W
2 zone con funzione Bridge
180x220 mm-2.100 (2.600)* (3.700)** W
* Powerboost - **Doppio Powerboost



Semifilo: 380x520 - foro: 350x490
Filotop: 380x520 - foro: vedi sito web

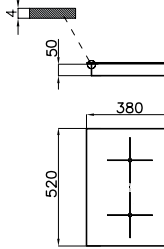



NEW



alimentazione:
mono-fase 230V~1P+N
frequenza 50÷60 Hz

S4000.Domino.Teppan.IS.2 Piano cottura a induzione

| | | |
|---|----------|-------------------|
|  | 7325 455 | € 2.651,00 |
| | | |

superficie in acciaio; 2 zone cottura indipendenti A e B; 9 livelli di potenza per zona; funzione Bridge; programmazione elettronica; comandi touch-control; 2 comandi Slider; recall; 2 timer indipendenti; pausa; dotazioni di sicurezza; Controllo elettronico della temperatura da 50° a 220 °C Temperature pre-impostate per: cottura carne, cottura pesce, pulizia. Accessori: distanziere (v. pag. 203)

P. max assorbita 2.800 W
2 zone cottura 2x1.400 W



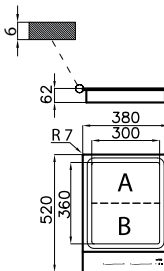

Dimensione: 380x520 - foro: 360x490

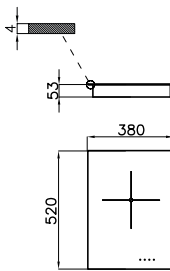

PIANI INDUZIONE

S4000 Domino

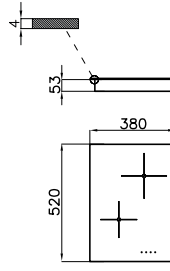
| Caratteristiche | Versione | Sigla | Prezzo € | Disegno Tecnico |
|--|--|-------|----------------|---|
|  <p>alimentazione: mono-fase 230V~1P+N frequenza 50÷60 Hz</p> | Piano cottura a induzione Finitura: Vetroceramica nero | | Q4 7321 240 | Q4: 380x520 - foro: 350x490 Filotop: 380x520 - foro: vedi sito web  |
| | programmazione elettronica; 9 settaggi di potenza per zona più funzione Powerboost; comandi touch control; timer indipendente; dotazioni di sicurezza | | FT 7321 240 | |
|  <p>alimentazione: mono-fase 230V~1P+N frequenza 50÷60 Hz</p> | Piano cottura a induzione Finitura: Vetroceramica nero | | Q4 7322 240 | Q4: 380x520 - foro: 350x490 Filotop: 380x520 - foro: vedi sito web  |
| | programmazione elettronica; 9 settaggi di potenza per zona più funzione Powerboost; comandi touch control; timer indipendente; dotazioni di sicurezza | | FT 7322 240 | |



Abbinamenti

S4000 Domino Gas
Vedi pagina 228

I piani S4000 Domino possono essere messi in sequenza con le cappe aspiranti da tavolo **Domino AIR** e **Domino Ghost** per una efficace e puntuale aspirazione.



S4000 Domino

| Finitura | Sigla | Prezzo € |
|----------|-------|----------|
|----------|-------|----------|

Distanziere per piani Domino



| | | |
|-----------------|----------|---------|
| Acciaio inox | 8320 000 | € 66,00 |
|-----------------|----------|---------|

Il distanziere in acciaio inox permette di creare un'unica superficie con i piani cottura domino aventi bordo verticale.

Dimensioni:
30x520 mm
spessore 4 mm

Disponibile anche **su misura** (a richiesta), il distanziere permette di aumentare lo spazio tra gli elementi della serie Domino e creare una pratica superficie d'appoggio.



Note per l'installazione in soluzione modulare continua

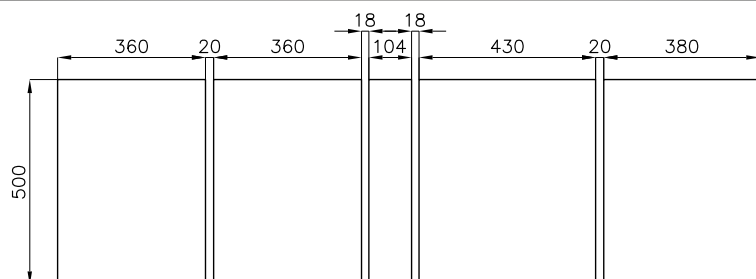

Installazione con fori d'incasso distinti

Per la corretta installazione in continuo va mantenuta una distanza di 20 mm tra i incassi dei prodotti (con eccezione di una distanza di 18 mm tra incasso cappa e altro prodotto). Per assicurare l'allineamento verticale dei prodotti si consiglia una profondità dell'incasso unica di 500 mm, indipendentemente dalla misura richiamata nel libretto (480, 490, 500 mm a seconda dei modelli).

Installazione con unico foro d'incasso mediante l'utilizzo del distanziere

Con l'utilizzo dei distanziere è possibile installare i prodotti in un unico foro da incasso, di 500 mm in profondità e in lunghezza pari alla somma delle dimensioni dei prodotti e dei distanziere, diminuita di 20 mm. Nell'esempio riportato, da SX:
 $(380+30+380+30+120+30+450+30+400)$ mm-20 mm=1830 mm

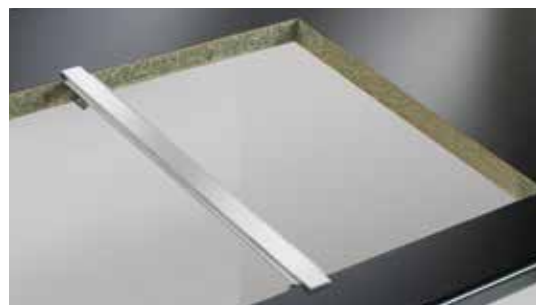
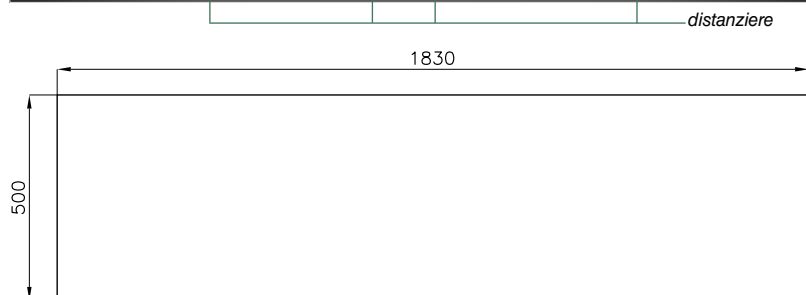











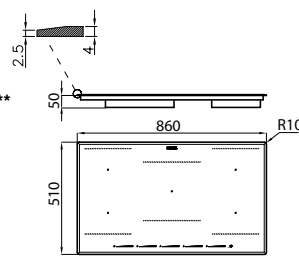

S4000 Domino si configura come incasso Q4, tuttavia, per vincoli progettuali, alcuni modelli hanno uno spessore leggermente maggiore. Questo comporta un piccolo scalino tra i prodotti nel caso di installazione in continuo: Teppan e cappa. Fare riferimento ai disegni dei singoli modelli, che riportano l'esatto spessore.

KE Induction NEW

PRESTAZIONI CON UN LOOK MINIMAL

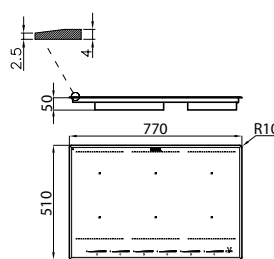

| Caratteristiche | Versione | Sigla | Prezzo € | Disegno Tecnico |
|--|--|-------|-------------------|---|
|  <p>Piano cottura a induzione Finitura: Vetroceramica nero funzione PowerControl programmazione elettronica; 5 zone cotture con doppia zona estesa Bridge 9 settaggi di potenza per zona più funzione Powerboost; comandi Slider; con LED bianchi; funzione mantenimento calore; Intelligent pot localization; pot detector; automatismo go&stop; pausa; recall; programmazione fine cottura; timer; Smart Fan System; dotazioni di sicurezza.</p> <p> </p> <p>alimentazione: mono-fase 230V~1P+N bi-fase 400V~2P+N frequenza 50÷60 Hz</p> |  SF 7384 645 | | € 1.764,00 | Semifilo: 860x510 - foro: 840x480 Filotop: 860x510 - foro: vedi sito web  |
| |  FT 7384 645 | | | |
|  <p>Piano cottura a induzione Finitura: Vetroceramica nero funzione PowerControl programmazione elettronica; 6 zone cotture con doppia zona estesa Bridge 9 settaggi di potenza per zona più funzione Powerboost; comandi Slider; con LED bianchi; funzione mantenimento calore; Intelligent pot localization; pot detector; automatismo go&stop; pausa; recall; programmazione fine cottura; timer; Smart Fan System; dotazioni di sicurezza.</p> <p> </p> <p>alimentazione: mono-fase 230V~1P+N bi-fase 400V~2P+N frequenza 50÷60 Hz</p> |  SF 7383 645 | | € 1.675,00 | Semifilo: 770x510 - foro: 750x480 Filotop: 770x510 - foro: vedi sito web  |
| |  FT 7383 645 | | | |



Caratteristiche | Versione | Sigla | Prezzo € | Disegno Tecnico



Piano cottura a induzione
 Finitura: Vetroceramica nero
 funzione PowerControl
 programmazione elettronica;
 4 zone cotture con doppia
 zona estesa Bridge
 9 settaggi di potenza per zona
 più funzione Powerboost;
 comandi Slider; con
 LED bianchi; funzione
 mantenimento calore;
 Intelligent pot localization;
 pot detector; automatismo
 go&stop; pausa; recall;
 programmazione fine cottura;
 timer; Smart Fan System;
 dotazioni di sicurezza.

alimentazione:
 mono-fase 230V~1P+N
 bi-fase 400V~2P+N
 frequenza 50÷60 Hz

| | |
|----|----------|
| SF | 7382 645 |
| FT | 7382 645 |

€ 1.244,00

P. max assorbita 2.800, 3.500, 4.500, 6.000, **7.400 W****

2 x 210x190 2.100 (3.000)* W

ø 200 2.300 (3.000)*W

ø 145 1.400 (1.850)*W

* Powerboost



Semifilo: **770x510** - foro: **750x480**
 Filotop: **770x510** - foro: vedi sito web

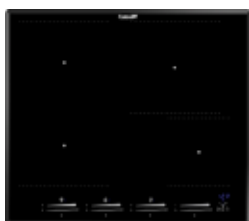
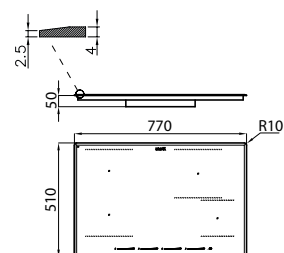

Piano cottura a induzione
 Finitura: Vetroceramica nero
 funzione PowerControl
 programmazione elettronica;
 4 zone cottura, zona estesa
 Bridge; 9 settaggi di potenza
 per zona più funzione
 Powerboost; comandi Slider;
 con LED bianchi;
 funzione mantenimento
 calore; Intelligent pot
 localization; pot detector;
 automatismo go&stop;
 pausa; recall;
 programmazione fine cottura;
 timer; Smart Fan System;
 dotazioni di sicurezza.

alimentazione:
 mono-fase 230V~1P+N
 bi-fase 400V~2P+N
 frequenza 50÷60 Hz

| | |
|----|----------|
| SF | 7381 645 |
| FT | 7381 645 |

€ 1.154,00

P. max assorbita 2.800, 3.500, 4.500, 6.000, **7.400 W****

2 x 210x190 2.100 (3.000)* W

ø 200 2.300 (3.000)*W

ø 145 1.400 (1.850)*W

* Powerboost



Semifilo: **580x510** - foro: **560x480**
 Filotop: **580x510** - foro: vedi sito web

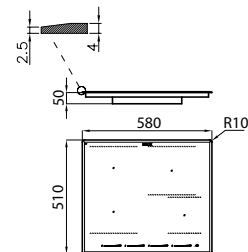

Piano cottura a induzione
 Finitura: Vetroceramica bianco
 funzione PowerControl
 programmazione elettronica;
 4 zone cottura, zona estesa
 Bridge; 9 settaggi di potenza
 per zona più funzione
 Powerboost; comandi Slider;
 funzione mantenimento
 calore; Intelligent pot
 localization; pot detector;
 automatismo go&stop;
 pausa; recall;
 programmazione fine cottura;
 timer; Smart Fan System;
 dotazioni di sicurezza.

alimentazione:
 mono-fase 230V~1P+N
 bi-fase 400V~2P+N
 frequenza 50÷60 Hz

| | |
|----|----------|
| SF | 7381 245 |
| FT | 7381 245 |

€ 1.154,00

P. max assorbita 2.800, 3.500, 4.500, 6.000, **7.400 W****

2 x 210x190 2.100 (3.000)* W

ø 200 2.300 (3.000)*W

ø 145 1.400 (1.850)*W

* Powerboost



Semifilo: **580x510** - foro: **560x480**
 Filotop: **580x510** - foro: vedi sito web

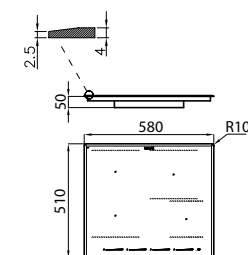

Piano cottura a induzione
 Finitura: Vetroceramica nero
 funzione PowerControl
 programmazione elettronica;
 2 zone cotture con doppia
 zona estesa Bridge
 9 settaggi di potenza
 per zona più funzione
 Powerboost;
 comandi Slider; con
 LED bianchi; funzione
 mantenimento calore;
 Intelligent pot localization;
 pot detector; automatismo
 go&stop; pausa; recall;
 programmazione fine cottura;
 timer; Smart Fan System;
 dotazioni di sicurezza.

alimentazione:
 mono-fase 230V~1P+N
 frequenza 50÷60 Hz

| | |
|----|----------|
| SF | 7380 645 |
| FT | 7380 645 |

€ 756,00

P. max assorbita 2.800, 3.500, **3.700 W****

2 x 210x190 2.100 (3.000)* W

* Powerboost



Semifilo: **290x510** - foro: **270x480**
 Filotop: **290x510** - foro: vedi sito web

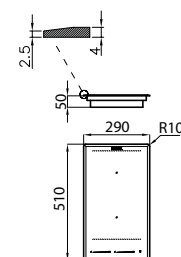

S1000 Induction



| Caratteristiche | Versione | Sigla | Prezzo € | Disegno Tecnico |
|-----------------|----------|-------|----------|-----------------|
|-----------------|----------|-------|----------|-----------------|



Piano cottura a induzione

Vetro nero
funzione

PowerControl
programmazione elettronica;
9 settaggi di potenza per zona più funzione Powerboost;
comandi touch control;
dotazioni di sicurezza

FT 7371 300

Q4 7371 300

€ 996,00

P. max assorbita 2.800, 3.500, 6.000, 7.200** W

sinistra Ø 210 mm-1.500 (2.000)* W

sinistra sup. Ø 145 mm-1.200 (1.600)* W

destra Ø 145 mm-1.200 (1.600)* W

destra sup. Ø 210 mm-1.500 (2.000)* W

* Powerboost

Q4: 770x510 - foro: 740x480
Filotop: 770x510 - foro: vedi sito web

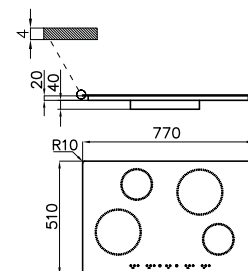

alimentazione:
mono-fase 230V~1P+N
bi-fase 400V~2P+N
frequenza 50÷60 Hz



Piano cottura a induzione

Vetro nero
funzione

PowerControl
programmazione elettronica;
9 settaggi di potenza per zona più funzione Powerboost;
comandi touch control;
dotazioni di sicurezza

FT 7370 300

Q4 7370 300

€ 872,00

P. max assorbita 2.800, 3.500, 6.000, 7.200** W

sinistra Ø 210 mm-1.500 (2.000)* W

sinistra sup. Ø 145 mm-1.200 (1.600)* W

destra Ø 145 mm-1.200 (1.600)* W

destra sup. Ø 210 mm-1.500 (2.000)* W

* Powerboost

Q4: 580x510 - foro: 560x480
Filotop: 580x510 - foro: vedi sito web

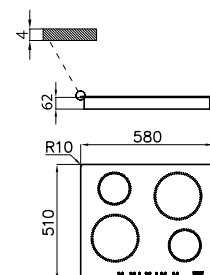

alimentazione:
mono-fase 230V~1P+N
bi-fase 400V~2P+N
frequenza 50÷60 Hz



S1000 Induction

| Caratteristiche | Versione | Sigla | Prezzo € | Disegno Tecnico |
|-----------------|----------|-------|----------|-----------------|
|-----------------|----------|-------|----------|-----------------|



NEW

kW

Piano cottura a induzione

| | |
|----|----------|
| FT | 7373 300 |
|----|----------|

| | |
|----|----------|
| Q4 | 7373 300 |
|----|----------|

€ 691,00

Vetro nero
programmazione elettronica;
9 settaggi di potenza per zona più
funzione Powerboost;
comandi touch control;
dotazioni di sicurezza

P. max assorbita 1.000, 1.500, 2.200, 2.800, 3.400, **5.200 W**

sinistra sup. Ø 145 mm-1.200 (1.600)* W

sinistra inf. Ø 240 mm-1.500 (2.000)* W

destra Ø 145 mm-1.200 (1.600)* W

* Powerboost

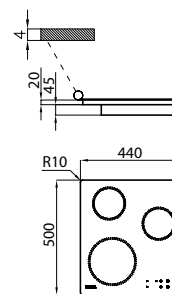
 Q4: 440x500 - foro: 420x485
 Filotop: 440x500 - foro: vedi sito web

alimentazione:
mono-fase 230V~1P+N
bi-fase 400V~2P+N
frequenza 50÷60 Hz

Piano cottura a induzione

| | |
|----|----------|
| FT | 7322 300 |
|----|----------|

| | |
|----|----------|
| Q4 | 7322 300 |
|----|----------|

€ 528,00

Vetro nero
programmazione elettronica;
9 settaggi di potenza per zona più
funzione Powerboost;
comandi touch control;
dotazioni di sicurezza

P. max assorbita **3.700 W**

superiore Ø 200 mm-2.300 (3.000)* W

inferiore Ø 160 mm-1.400 W

* Powerboost

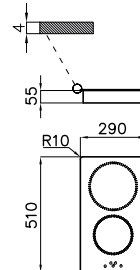
 Q4: 290x510 - foro: 270x490
 Filotop: 290x510 - foro: vedi sito web

alimentazione:
mono-fase 230V~1P+N
frequenza 50÷60 Hz



**con la funzione PowerControl, la potenza massima può essere impostata in utenza ai valori riportati





Connessione del sistema Modular

Disposizione degli elementi

Il sistema Modular permette la libera disposizione dei suoi elementi. L'unico limite è dato dalla lunghezza dei cavi che collegano gli elementi con il box di connessione: **60 cm per il modulo touch e 90 cm per le zone di cottura.**

Combinazioni zone cottura

Il piano può essere composto in piena libertà; alcune combinazioni di piastre non compatibili sono segnalate tra le note dei Moduli Touch control.

Box di connessione

L'installazione è immediata e intuitiva. Il box può essere posto a muro dietro al cabinet o all'interno di esso, sotto al piano cottura.

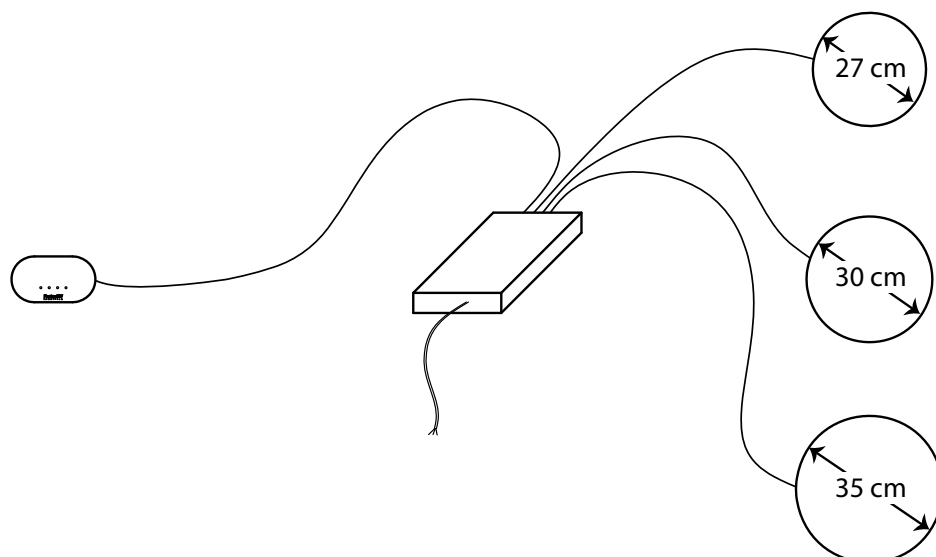

Serie Modular & Modular Quadra

Massima libertà

Modular Induction è la nuova proposta Foster che vi permette la piena libertà di comporre il vostro piano ad induzione in base allo spazio disponibile e alle specifiche esigenze.

Infinite possibilità

I tre modelli di piastra, differenti per diametro e potenza, possono essere posizionati con grande flessibilità in combinazioni di due, tre o quattro zone controllate dai rispettivi pannelli touch control.

Installazione intuitiva

L'installazione è semplice e immediata grazie al box di connessione, facilmente posizionabile nel sottopiano, che collega le piastre al touch control.

Coordinato al vostro stile

Modular Induction è disponibile nelle versioni nero o bianco per una perfetta armonia con il vostro top e la vostra cucina.



Serie Modular



Pannello Touch control; programmazione elettronica indipendente delle zone di cottura; 9 settaggi di potenza per zona più funzione Powerboost; comando Slider; comandi touch control; automatismo go&stop; dotazioni di sicurezza.

Da ordinare con relativo box di connessione
Lunghezza cavo di connessione: 60 cm



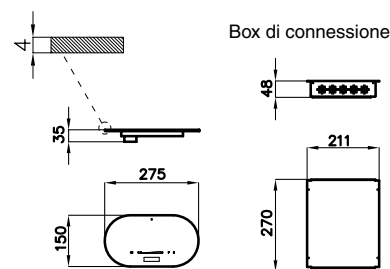

Nota: il Touch control Modular necessita di una semplice configurazione, in funzione della combinazione di piastre associate, come indicato nel manuale di installazione.



alimentazione:
mono-fase 230V~1P+N
bi-fase 400V~2P+N
frequenza 50±60 Hz

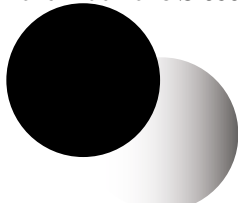
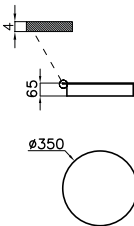

Dimensioni: 275x150 mm R75
Foro incasso filotop: vedi sito web

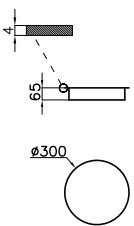
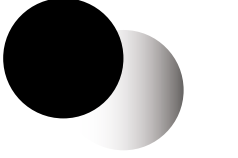
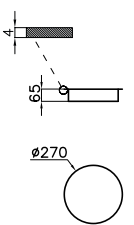
| | Versione | Sigla | Prezzo € | |
|--|--|-----------------------------------|---------------------------------|---|
| Touch control per 4 zone  | FT | nero + box di connessione | 7368 040 + 7369 040 | € 472,00 € 301,00 |
| | FT | bianco + box di connessione | 7368 045 + 7369 040 | € 514,00 € 301,00 |
| | Combinazioni zone cottura collegabili: - 2 zone 7361 27* - 2 zone libere (qualsiasi modello) | | | |
| | Touch control per 3 zone  | FT | nero + box di connessione | 7368 030 + 7369 030 |
| FT | | bianco + box di connessione | 7368 035 + 7369 030 | € 514,00 € 301,00 |
| Combinazioni zone cottura collegabili: - 1 zona 7361 27* - 2 zone libere (qualsiasi modello) | | | | |
| Touch control per 2 zone  | | FT | nero + box di connessione | 7368 020 + 7369 020 |
| | FT | bianco + box di connessione | 7368 025 + 7369 020 | € 514,00 € 301,00 |
| | Combinazioni zone cottura collegabili: - 2 zone libere (qualsiasi modello) | | | |
| | Zona induzione Ø 350  | FT | nero | 7363 350 |
| FT | | bianco | 7363 355 | € 586,00 |
| | | | |  foro incasso filotop: vedi sito web P. max assorbita 2.300 (3.000)* W * Powerboost |
| Zona induzione Ø 300  | FT | nero | 7362 300 | € 480,00 |
| | FT | bianco | 7362 305 | € 529,00 |
| | | | |  foro incasso filotop: vedi sito web P. max assorbita 2.300 (3.000)* W * Powerboost |
| Zona induzione Ø 270  | FT | nero | 7361 270 | € 440,00 |
| | FT | bianco | 7361 275 | € 483,00 |
| | | | |  foro incasso filotop: vedi sito web P. max assorbita 1.100 (1.400)* W * Powerboost |

Configurazioni Modular

Gli articoli sotto riportati rappresentano alcune nostre proposte già configurate, e non escludono la possibilità di altre combinazioni di piastre. La disposizione degli elementi sul top rimane libera, con i vincoli riportati alla sezione "Connessione del Sistema Modular Induction"

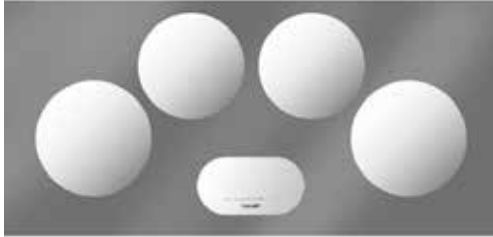
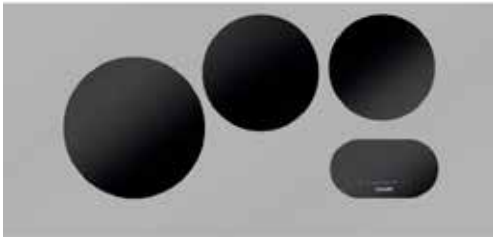
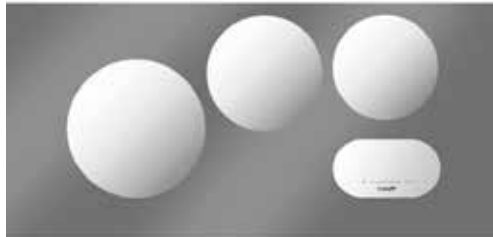
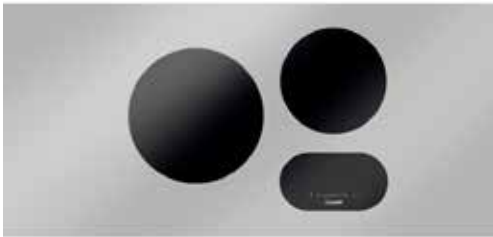
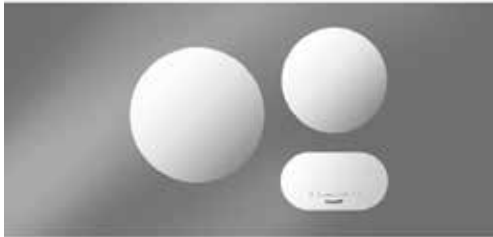
| | Sigla | Prezzo € | | Sigla | Prezzo € | | |
|----------------------------|----------|------------|---|------------------------------|----------|------------|---|
| 4 zone nero - tondo | 7366 040 | € 2.614,00 |  | 4 zone bianco - tondo | 7366 045 | € 2.838,00 |  |
| | | | 1 Touch control 1 box di connessione 2 zone Ø 300 2 zone Ø 270 | | | | 1 Touch control 1 box di connessione 2 zone Ø 300 2 zone Ø 270 |
| 3 zone nero - tondo | 7366 030 | € 2.226,00 |  | 3 zone bianco - tondo | 7366 035 | € 2.412,00 |  |
| | | | 1 Touch control 1 box di connessione 1 zona Ø 350 1 zona Ø 300 1 zona Ø 270 | | | | 1 Touch control 1 box di connessione 1 zona Ø 350 1 zona Ø 300 1 zona Ø 270 |
| 2 zone nero - tondo | 7366 020 | € 1.746,00 |  | 2 zone bianco - tondo | 7366 025 | € 1.885,00 |  |
| | | | 1 Touch control 1 box di connessione 1 zona Ø 350 1 zona Ø 270 | | | | 1 Touch control 1 box di connessione 1 zona Ø 350 1 zona Ø 270 |



Serie Modular Quadra



Pannello Touch control; programmazione elettronica indipendente delle zone di cottura; 9 settaggi di potenza per zona più funzione Powerboost; comando Slider; comandi touch control; automatismo go&stop; dotazioni di sicurezza.

Da ordinare con relativo box di connessione
Lunghezza cavo di connessione: 60 cm



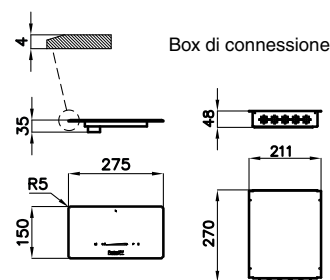













Nota: il Touch control Modular necessita di una semplice configurazione, in funzione della combinazione di piastre associate, come indicato nel manuale di installazione.

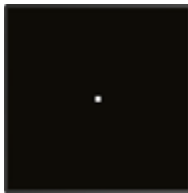

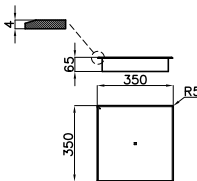
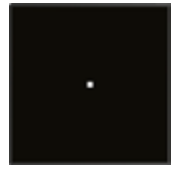
alimentazione:
mono-fase 230V~1P+N
bi-fase 400V~2P+N
frequenza 50÷60 Hz

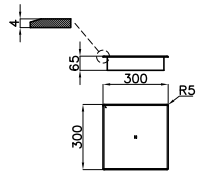

Dimensioni: 275x150 mm R5
Foro incasso filotop: vedi sito web

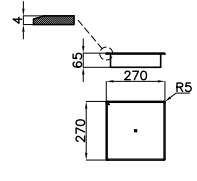
| | | Versione | Sigla | Prezzo € | |
|--|--|----------------------------|---------------|---------------|---|
| Touch control per 4 zone  |   | T. Control | 7367 040 | € 490,00 | Combinazioni zone cottura collegabili: - 2 zone 7364 270 - 2 zone libere (qualsiasi modello) |
| | | + box di connessione | + 7369 040 | + € 301,00 | |
| Touch control per 3 zone  |   | T. Control | 7367 030 | € 490,00 | Combinazioni zone cottura collegabili: - 1 zona 7364 270 - 2 zone libere (qualsiasi modello) |
| | | + box di connessione | + 7369 030 | + € 301,00 | |
| Touch control per 2 zone  |   | T. Control | 7367 020 | € 490,00 | Combinazioni zone cottura collegabili: - 2 zone libere (qualsiasi modello) |
| | | + box di connessione | + 7369 020 | + € 301,00 | |
| Zona induzione Ø 350  |   | | 7366 350 | € 586,00 | foro incasso filotop: vedi sito web  |
| | | | | | P. max assorbita 2.300 (3.000)* W * Powerboost |
| Zona induzione Ø 300  |   | | 7365 300 | € 528,00 | foro incasso filotop: vedi sito web  |
| | | | | | P. max assorbita 2.300 (3.000)* W * Powerboost |
| Zona induzione Ø 270  |   | | 7364 270 | € 485,00 | foro incasso filotop: vedi sito web  |
| | | | | | P. max assorbita 1.100 (1.400)* W * Powerboost |

Configurazioni Modular Quadra

Gli articoli sotto riportati rappresentano alcune nostre proposte già configurate, e non escludono la possibilità di altre combinazioni di piastre. La disposizione degli elementi sul top rimane libera, con i vincoli riportati alla sezione "Connessione del Sistema Modular Induction" (a pag. 208).

| | Sigla | Prezzo € |
|------------------------|----------|------------|
| 4 zone nero - Q | 7365 040 | € 2.875,00 |

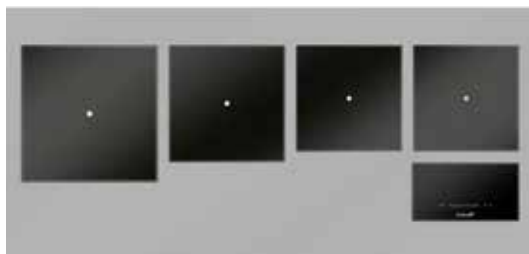

1 Touch control
1 box di
connessione
1 zona 300 mm
2 zone 270 mm
1 zona 350 mm

| | Sigla | Prezzo € |
|------------------------|----------|------------|
| 3 zone nero - Q | 7365 030 | € 2.389,00 |



1 Touch control
1 box di
connessione
1 zona 350 mm
1 zona 300 mm
1 zona 270 mm

| | | |
|------------------------|----------|------------|
| 2 zone nero - Q | 7365 020 | € 1.862,00 |
|------------------------|----------|------------|



1 Touch control
1 box di
connessione
1 zona 350 mm
1 zona 270 mm





PIANI COTTURA A GAS

Risparmio energetico con la massima efficienza.

Foster Milano
p. 219

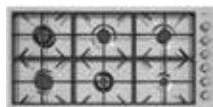

Milanello 5F
p. 222

NEW



Milanello
p. 224

NEW



Milanello PVD
p. 225

NEW



S4000
p. 227

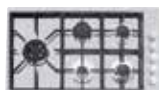

S4000 Domino
p. 228



S4000 Line XL
p. 229



S4000 Line
p. 230



Quadra Angolare
p. 231



FL p. 232

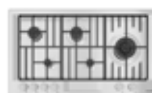

KE p. 234



KE black
p. 235



KE PVD
p. 236



KE Line
p. 237



KF Marine
p. 238



KS
p. 239



Ceramik
p. 240



Professionale
p. 242



Veronika
p. 243



Power
p. 244

NEW



Elettra
p. 245



Angolare
p. 246



Alta efficienza e attenzione per la natura



Una proposta ampia e moderna, con tecnologie che consentono grande risparmio energetico. I nuovi bruciatori ad alta efficienza risparmiano dal 20% al 25% il consumo di gas rispetto ai piani tradizionali.

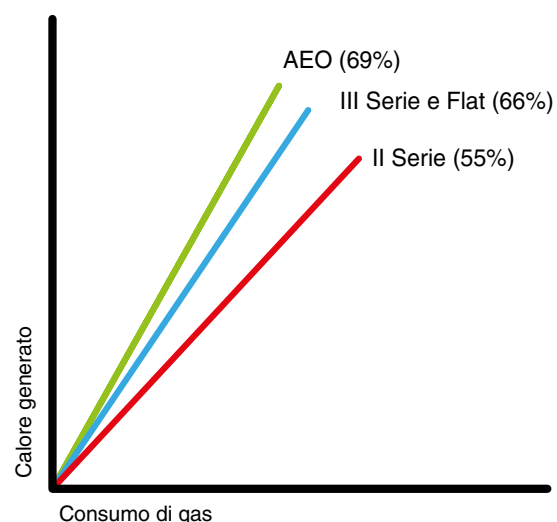

Bruciatori



bruciatori Alta Efficienza (AEO): 5 kW e risparmio del 25% di gas

I nuovi bruciatori AEO (alta efficienza) hanno un rendimento massimo del 69%, il bruciatore DUAL AEO raggiunge la potenza massima di 5 kW. L'anello spartifiamma in ottone, contribuisce a conferire l'aspetto professionale.



bruciatori III^ serie: risparmio 20% di gas

Garantiscono un'efficienza ben superiore agli standard europei. Il sistema bloccante tra coperchio e spartifiamma garantisce il perfetto posizionamento e maggiore praticità nella pulizia.



bruciatori Dual: prestazioni e versatilità. da 300 a 4.500 W

Innovativo e versatile bruciatore, con tre corone di fuoco ad accensione indipendente azionate da un'unica manopola. È in grado di erogare potenze da 300 a 4500 W.



bruciatori Flat con sistema PrecisePower: grande controllo nella regolazione

Massima precisione nella regolazione della fiamma, grazie ai 10 livelli predefiniti del sistema PrecisePower. Il tutto con l'estetica accattivante e ultrapiatta dei nuovi bruciatori Flat.

Caratteristiche

La sicurezza in cucina

I bruciatori sono ancora più sicuri e anche il tempo per l'accensione è ridotto al minimo, grazie alle termocoppie di ultima generazione ad intervento ultra rapido.



Cottura sicura

Tutti i piani Foster sono dotati di valvole di sicurezza che, nel caso di accidentale spegnimento della fiamma, interrompono l'erogazione del gas in tempi velocissimi.



Accensione sottomanopola

Massima libertà di movimento con l'accensione elettrica sottomanopola, che permette l'attivazione della fiamma con una sola mano.



Ultrapiani

I modelli ultrapiani sono il classico esempio di incontro tra estetica e funzionalità. Eleganti griglie, che formano un'unica ampia superficie.

Griglie

Tutti i piani Foster sono dotati di griglie in ghisa, materiale perfetto per le tante proprietà.



Pura eleganza

Le coniche forme dei bruciatori si ergono dal piano evocative della forza del fuoco. Le griglie sormontano i bruciatori lasciando "pulito" il piano cottura.



Le proprietà della ghisa

Alta capacità termica che migliora i rendimenti; peso e stabilità che migliorano la sicurezza; robustezza che mantiene inalterato l'aspetto originale; facilità di pulizia.

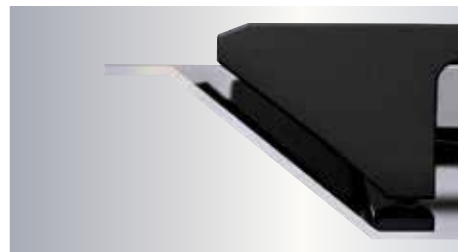

Invaso profondo

Accoglie i bruciatori e le griglie, permettendo a quest'ultime di realizzare un'unica superficie di lavoro. L'inclinazione dell'invaso rende facile la pulizia degli spigoli.

Caratteristiche

Oltre l'incasso

Foster è stata la prima produttrice ad impegnarsi in sistemi di inserimento e oggi vanta una notevole esperienza e la più completa gamma disponibile con inserimento a filo e semifilo.



Standard

Tipo di incasso tradizionale con il bordo che sporge di 8 mm sul piano di lavoro.



Q4

Incasso con profilo squadrato ed una sporgenza dal piano di soli 4 mm.



Semifilo

Bordo inclinato che sporge solo 3 mm sul top. Eleganza e facilità di installazione.



Filotop

Si inserisce in un ribasso del top e risulta perfettamente a filo. In alternativa, può essere installato in appoggio.



Integrato

La soluzione più elegante e professionale, in modo da costruire un blocco unico senza alcuna discontinuità.

accessori

1



Porta wok
9601 668
€ 29,00

2



Porta wok
9601 727
€ 25,00

3



Bistecchiera 44x22 cm
8172 000
€ 81,00

4



Placca in ghisa
9601 742
€ 48,00

5



Placca in ghisa
9601 741
€ 48,00

Foster Milano



Foster Milano

PIANI GAS

Foster Milano

PUREZZA FORMALE, PERFORMANCE PROFESSIONALE



Bruciatori Alta Efficienza
Risparmio energetico 25%

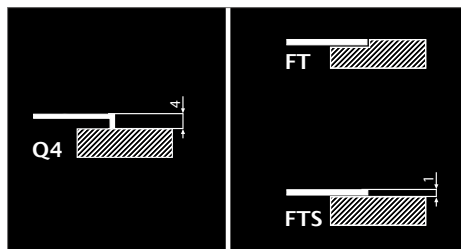

Flessibilità d'installazione

Disponibile in più tipologie di incasso: filotop (FT), nella elegante versione con bordo (Q4), o inserendo la versione filotop in appoggio, con lo spessore di un millimetro che sporge dal piano (FTS).



Griglie XXL

La griglia ha dimensioni straordinarie, 33x25 cm, e crea una superficie di lavoro fino al 50% più grande rispetto ad un normale piano di cottura domestico.



Superficie Ultrapiatta

Le griglie formano una superficie continua, che sporge di pochi millimetri dal piano, sulla quale si possono spostare con facilità e sicurezza pentole di grandi dimensioni.



Bruciatori Alta Efficienza

I bruciatori AE garantiscono un risparmio energetico fino al 25% rispetto ai bruciatori standard. Tutti i modelli hanno almeno un bruciatore wok dual da 4.2 kW.



Porta Wok in ghisa











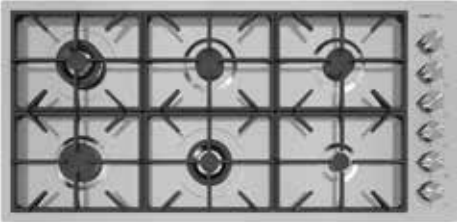

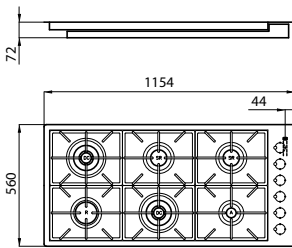

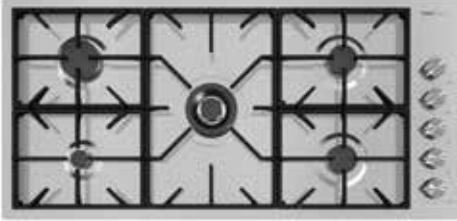

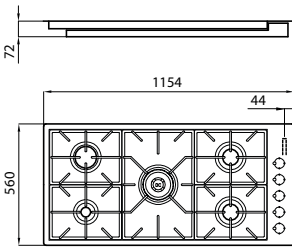

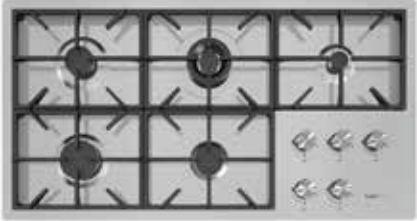

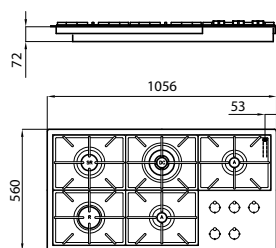
Tutti i piani cottura Foster Milano hanno di serie il prezioso porta-wok in ghisa, che permette l'utilizzo delle padelle a fondo concavo.

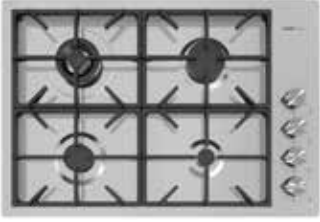

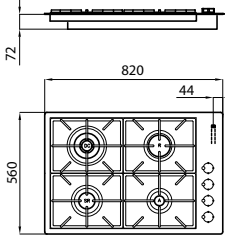
La manopola Foster Milano

La preziosa manopola in metallo, con finitura satinata, è l'elemento identificativo dell'intera serie. È presente sul piano cottura, sul forno e sul lavello.

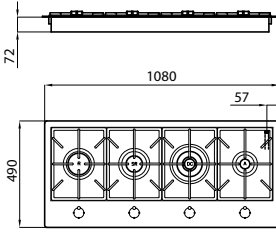
Foster Milano

| Caratteristiche | Versione | Sigla | Prezzo € | Disegno Tecnico |
|---|---|----------|-------------------|--|
|  <p>AISI 304 spazzolato Griglie in ghisa e coprispartifiamma smaltati Potenza tot. 15.900 W ausiliario: 1.000 W semirapido: 2x1.750 W</p> |  FT | 7639 000 | € 2.373,00 | Filotop: 1154x560 - foro (FT): vedi sito web foro filotop in appoggio (FTS): 1134x540  <p>Le quote si riferiscono alla versione d'incasso filotop</p> |
| |  FTS | 7639 000 | | |
| In dotazione: 2x 2 (vedi pag. 218) | | | | |
|  <p>AISI 304 spazzolato Griglie in ghisa e coprispartifiamma smaltati Potenza tot. 11.700 W ausiliario: 1.000 W semirapido: 2x1.750 W</p> |  FT | 7636 000 | € 2.337,00 | Filotop: 1154x560 - foro (FT): vedi sito web foro filotop in appoggio (FTS): 1134x540  <p>Le quote si riferiscono alla versione d'incasso filotop</p> |
| |  FTS | 7636 000 | | |
| In dotazione: 2 (vedi pag. 218) | | | | |
|  <p>AISI 304 spazzolato Griglie in ghisa e coprispartifiamma smaltati Potenza tot. 10.950 W ausiliario: 2x1.000 W semirapido: 1.750 W rapido: 3.000 W dual: 4.200 W Accensione elettrica Valvolatura di sicurezza con termocoppia ad intervento rapido</p> |  FT | 7638 000 | € 2.353,00 | Filotop: 1056x560 - foro (FT): vedi sito web foro filotop in appoggio (FTS): 1036x540  <p>Le quote si riferiscono alla versione d'incasso filotop</p> |
| |  FTS | 7638 000 | | |
| In dotazione: 2 (vedi pag. 218) | | | | |
|  <p>AISI 304 spazzolato Griglie in ghisa e coprispartifiamma smaltati Potenza tot. 9.950 W ausiliario: 1.000 W semirapido: 1.750 W rapido: 3.000 W dual: 4.200 W Accensione elettrica Valvolatura di sicurezza con termocoppia ad intervento rapido</p> |  FT | 7637 000 | € 1.969,00 | Filotop: 820x560 - foro (FT): vedi sito web foro filotop in appoggio (FTS): 800x540  <p>Le quote si riferiscono alla versione d'incasso filotop</p> |
| |  FTS | 7637 000 | | |
| In dotazione: 2 (vedi pag. 218) | | | | |
|  <p>AISI 304 spazzolato Griglie in ghisa e coprispartifiamma smaltati Potenza tot. 9.950 W ausiliario: 1.000 W semirapido: 1.750 W rapido: 3.000 W dual: 4.200 W Accensione elettrica Valvolatura di sicurezza con termocoppia ad intervento rapido</p> |  FT | 7640 000 | € 2.001,00 | Filotop: 1080x490 - foro (FT): vedi sito web foro filotop in appoggio (FTS): 1060x470  <p>Le quote si riferiscono alla versione d'incasso filotop</p> |
| |  FTS | 7640 000 | | |
| In dotazione: 2 (vedi pag. 218) | | | | |

PIANI GAS









Milanello 5F **NEW**











PrecisePower: grande controllo nella regolazione

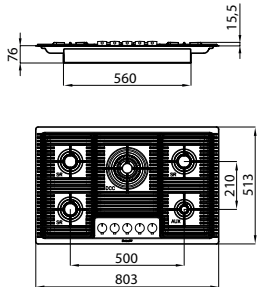

- 10 livelli di potenza
- massima precisione nelle regolazioni della fiamma
- estetica ultra-piatta

| | Caratteristiche | Versione | Sigla | Prezzo € | Disegno Tecnico |
|---|--|---|----------|-------------------|---|
|  | AISI 304 spazzolato Griglie in ghisa e coprispartifiamma smaltati. Bruciatori Flat Potenza tot. 10.250 W ausiliario: 1.000 W semirapido: 3x1.750 W doppia corona: 4.000 W Accensione elettrica Valvolatura di sicurezza con termocoppia ad intervento rapido |  FT | 7682 000 | € 1.370,00 | Filotop: 803x513 - foro (FT): vedi sito web foro filotop in appoggio (FTS): 790x500  |
| | |  FTS | 7682 000 | | |
| Accessori: 2 (vedi pag. 218) | | | | | |
|  | AISI 304 Gun Metal Griglie in ghisa e coprispartifiamma smaltati. Bruciatori Flat Potenza tot. 10.250 W ausiliario: 1.000 W semirapido: 3x1.750 W doppia corona: 4.000 W Accensione elettrica Valvolatura di sicurezza con termocoppia ad intervento rapido |  FT | 7682 006 | € 1.962,00 | Filotop: 803x513 - foro (FT): vedi sito web foro filotop in appoggio (FTS): 790x500  |
| | |  FTS | 7682 006 | | |
| Accessori: 2 (vedi pag. 218) | | | | | |

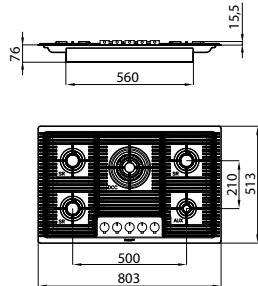







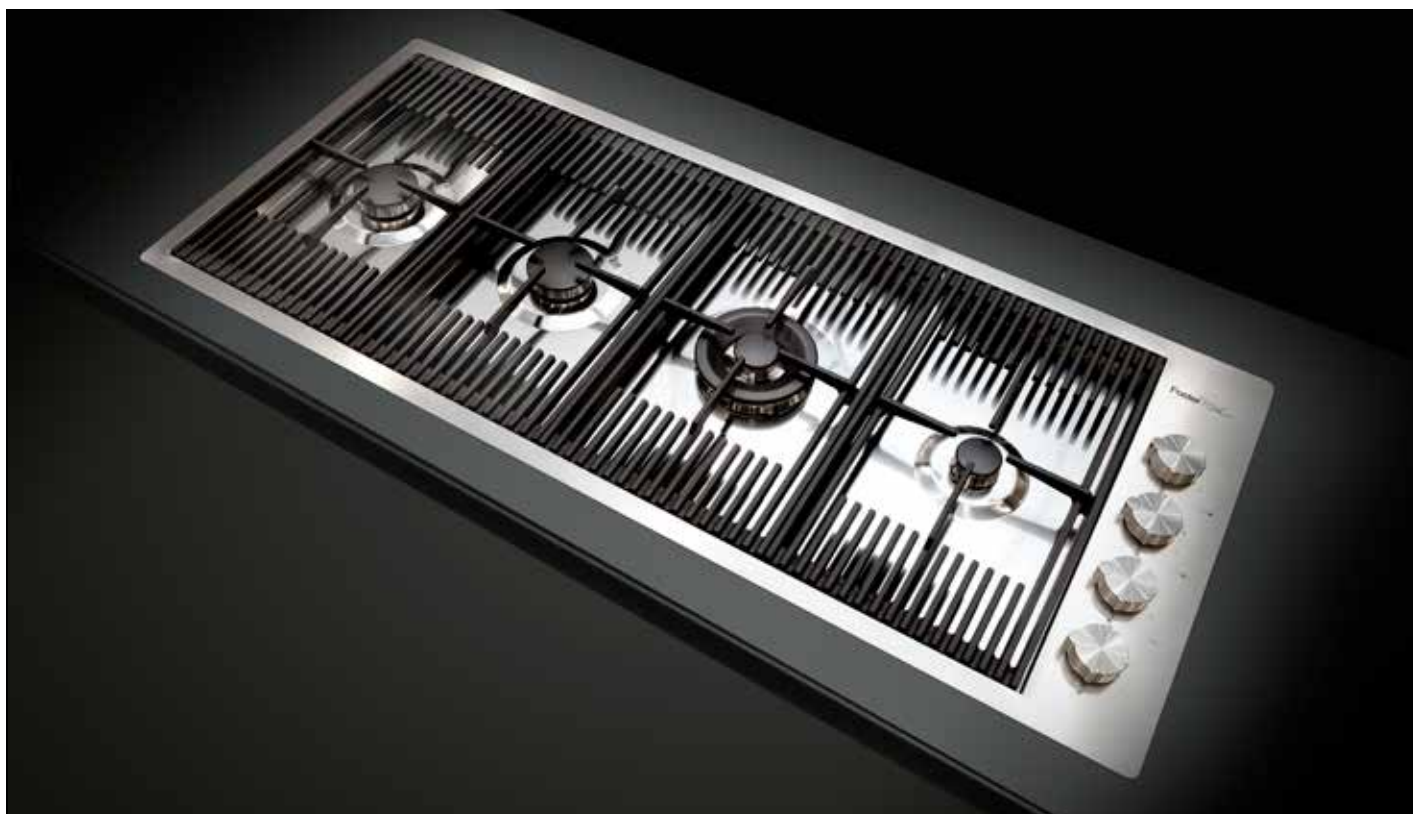

| | Caratteristiche | Versione | Sigla | Prezzo € | Disegno Tecnico |
|--|---|---|----------|-------------------|--|
|  | <p>NEW AISI 304 Copper Griglie in ghisa e coprispartifiamma smaltati. Bruciatori Flat Potenza tot. 10.250 W ausiliario: 1.000 W semirapido: 3x1.750 W doppia corona: 4.000 W</p> <p>Accensione elettrica</p> <p>Valvolatura di sicurezza con termocoppia ad intervento rapido</p> |  FT | 7682 008 | <p>€ 1.962,00</p> | <p>Filotop: 803x513 - foro (FT): vedi sito web foro filotop in appoggio (FTS): 790x500</p>  |
| | |  FTS | 7682 008 | | |
| Accessori: 2 (vedi pag. 218) | | | | | |
|  | <p>NEW AISI 304 Gold Griglie in ghisa e coprispartifiamma smaltati. Bruciatori Flat Potenza tot. 10.250 W ausiliario: 1.000 W semirapido: 3x1.750 W doppia corona: 4.000 W</p> <p>Accensione elettrica</p> <p>Valvolatura di sicurezza con termocoppia ad intervento rapido</p> |  FT | 7682 009 | <p>€ 1.962,00</p> | <p>Filotop: 803x513 - foro (FT): vedi sito web foro filotop in appoggio (FTS): 790x500</p>  |
| | |  FTS | 7682 009 | | |
| Accessori: 2 (vedi pag. 218) | | | | | |

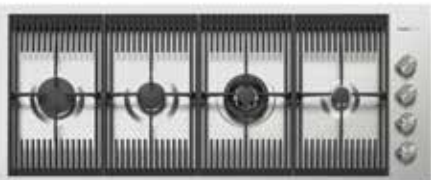
Milanello

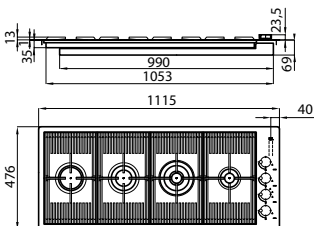
L'ELEGANZA DELLA COLLEZIONE MILANO ASSIEME ALLA FUNZIONALITÀ DEI FUOCHI IN LINEA

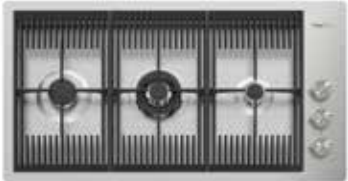

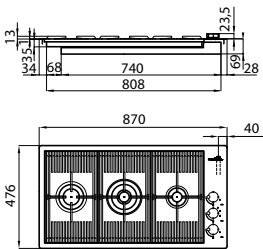



Bruciatori Alta Efficienza
Risparmio energetico 25%

| Caratteristiche | Versione | Sigla | Prezzo € | Disegno Tecnico |
|--|---|----------|-------------------|--|
|  <p>AISI 304 spazzolato Griglie in ghisa e coprispartifiamma smaltati Potenza tot. 10.750 W ausiliario: 1.000 W semirapido: 1.750 W</p> <p>rapido: 3.000 W dual: 5.000 W Accensione elettrica Valvolatura di sicurezza con termocoppia ad intervento rapido</p> |  FT | 7681 000 | € 1.848,00 | Filtop: 1115X476 - foro (FT): vedi sito web foro filtop in appoggio (FTS): 1098X459  |
| |  FTS | 7681 000 | | |
|  <p>AISI 304 spazzolato Griglie in ghisa e coprispartifiamma smaltati Potenza tot. 7.750 W ausiliario: 1.000 W semirapido: 1.750 W</p> <p>dual: 5.000 W Accensione elettrica Valvolatura di sicurezza con termocoppia ad intervento rapido</p> |  FT | 7680 000 | € 1.551,00 | Filtop: 870x476 - foro (FT): vedi sito web foro filtop in appoggio (FTS): 853x459  |
| |  FTS | 7680 000 | | |

Milanello PVD

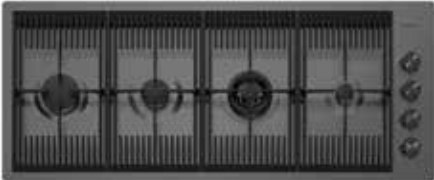
NEW

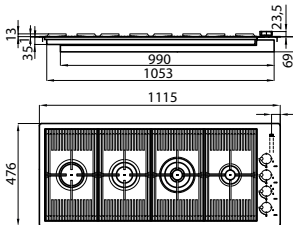
Foster 

| Caratteristiche | Versione | Sigla | Prezzo € | Disegno Tecnico |
|--|---|----------|------------|---|
|  |  | 7681 006 | € 2.882,00 | Filotop: 1115x476 - foro (FT): vedi sito web foro filotop in appoggio (FTS): 1098x459  |
| |  | 7681 006 | | |
| Accessori: 2 (vedi pag. 218) | | | | |

AISI 304 Gun Metal
 Griglie in ghisa e
 coprispartifiamma smaltati
 Potenza tot. 10.750 W
 ausiliario: 1.000 W
 semirapido: 1.750 W

rapido: 3.000 W
 dual: 5.000 W
 Accensione elettrica
 Valvolatura di sicurezza
 con termocoppia
 ad intervento rapido

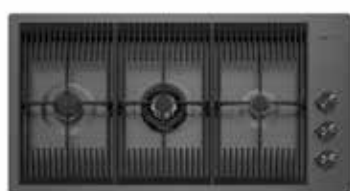

| | | |
|---|----------|------------|
|  | 7680 006 | € 2.632,00 |
|  | 7680 006 | |

Filotop: **870x476** - foro (FT): vedi sito web
 foro filotop in appoggio (FTS): **853x459**

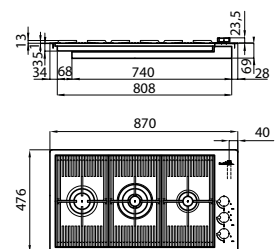

Accessori: **2** (vedi pag. 218)

AISI 304 Gun Metal
 Griglie in ghisa e
 coprispartifiamma smaltati
 Potenza tot. 7.750 W
 ausiliario: 1.000 W
 semirapido: 1.750 W

dual: 5.000 W
 Accensione elettrica
 Valvolatura di sicurezza
 con termocoppia
 ad intervento rapido

Nelle versioni Gun metal e Copper
 anche le manopole sono trattate
 con finitura PVD per una perfetta
 armonia di colori e finiture.

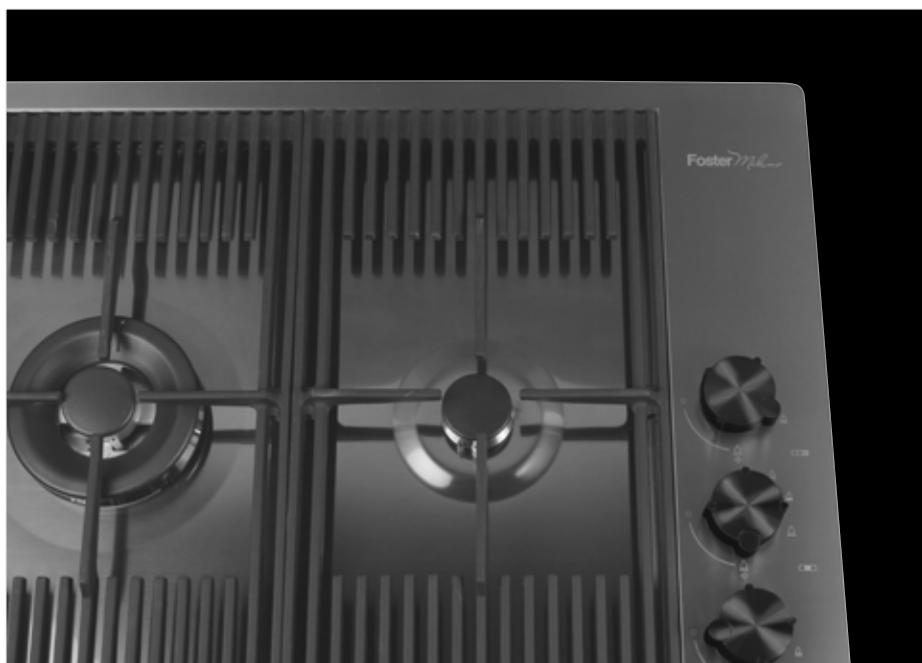

Milanello PVD **NEW**

Caratteristiche | Versione | Sigla | Prezzo € | Disegno Tecnico

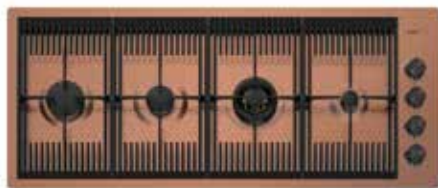

| | | |
|------------|----------|-------------------|
| FT | 7681 008 | € 2.882,00 |
| FTS | 7681 008 | |

Filotop: **1115X476** - foro (FT): vedi sito web
foro filotop in appoggio (FTS): **1098X459**

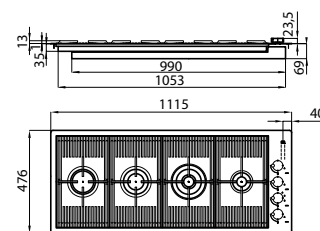

Accessori: **2** (vedi pag. 218)

AISI 304 Copper
Griglie in ghisa e coprispartifiamma smaltati
Potenza tot. 10.750 W
ausiliario: 1.000 W
semirapido: 1.750 W

rapido: 3.000 W
dual: 5.000 W
Accensione elettrica
Valvolatura di sicurezza con termocoppia ad intervento rapido



| | | |
|------------|----------|-------------------|
| FT | 7680 008 | € 2.632,00 |
| FTS | 7680 008 | |

Filotop: **870x476** - foro (FT): vedi sito web
foro filotop in appoggio (FTS): **853x459**

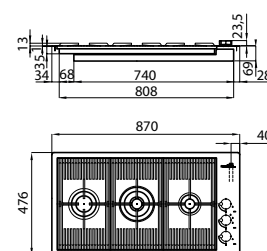

Accessori: **2** (vedi pag. 218)

AISI 304 Copper
Griglie in ghisa e coprispartifiamma smaltati
Potenza tot. 7.750 W
ausiliario: 1.000 W
semirapido: 1.750 W

dual: 5.000 W
Accensione elettrica
Valvolatura di sicurezza con termocoppia ad intervento rapido



| | | |
|------------|----------|-------------------|
| FT | 7681 009 | € 2.882,00 |
| FTS | 7681 009 | |

Filotop: **1115X476** - foro (FT): vedi sito web
foro filotop in appoggio (FTS): **1098X459**

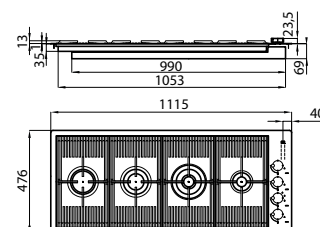

Accessori: **2** (vedi pag. 218)

AISI 304 Gold
Griglie in ghisa e coprispartifiamma smaltati
Potenza tot. 10.750 W
ausiliario: 1.000 W
semirapido: 1.750 W

rapido: 3.000 W
dual: 5.000 W
Accensione elettrica
Valvolatura di sicurezza con termocoppia ad intervento rapido



| | | |
|------------|----------|-------------------|
| FT | 7680 009 | € 2.632,00 |
| FTS | 7680 009 | |

Filotop: **870x476** - foro (FT): vedi sito web
foro filotop in appoggio (FTS): **853x459**

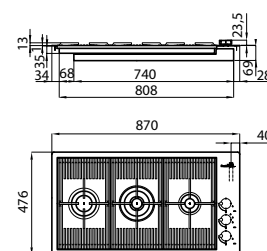

Accessori: **2** (vedi pag. 218)

AISI 304 Gold
Griglie in ghisa e coprispartifiamma smaltati
Potenza tot. 7.750 W
ausiliario: 1.000 W
semirapido: 1.750 W









dual: 5.000 W
Accensione elettrica
Valvolatura di sicurezza con termocoppia ad intervento rapido

S4000

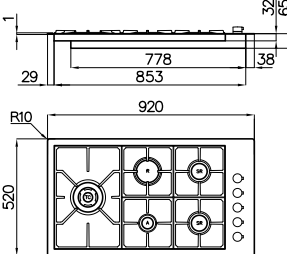
POTENZA ED EFFICIENZA ENERGETICA SENZA COMPROMESSI



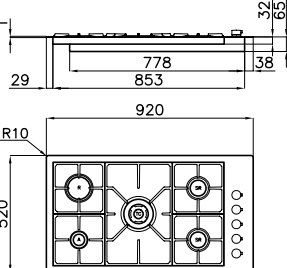



 **Piani cottura nuova generazione risparmio energetico 20%**

| | Caratteristiche | Versione | Sigla | Prezzo € | Disegno Tecnico |
|---|---|---|----------|------------|---|
|  | AISI 304 spazzolato Griglie in ghisa e coprispartifiamma smaltati Potenza tot. 11.400 W ausiliario: 1.100 W semirapido: 2x1.750 W rapido: 3.000 W tripla corona: 3.800 W Accensione elettrica Valvolatura di sicurezza con termocoppia ad intervento rapido |  FT | 7257 032 | € 1.787,00 | Filotop: 920x520 - foro (FT): vedi sito web foro filotop in appoggio (FTS): 900x500  |
| | |  FTS | 7257 032 | | |
| In dotazione: 1 Accessori Filotop: 4 (vedi pag. 218) | Le quote si riferiscono alla versione d'incasso filotop | | | | |
|  | AISI 304 spazzolato Griglie in ghisa e coprispartifiamma smaltati Potenza tot. 11.400 W ausiliario: 1.100 W semirapido: 2x1.750 W rapido: 3.000 W tripla corona: 3.800 W Accensione elettrica Valvolatura di sicurezza con termocoppia ad intervento rapido |  FT | 7271 032 | € 1.787,00 | Filotop: 920x520 - foro (FT): vedi sito web foro filotop in appoggio (FTS): 900x500  |
| | |  FTS | 7271 032 | | |
| In dotazione: 1 Accessori Filotop: 4 (vedi pag. 218) | Le quote si riferiscono alla versione d'incasso filotop | | | | |

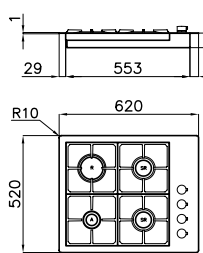
PIANI GAS

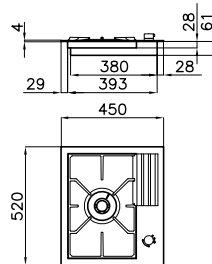
S4000

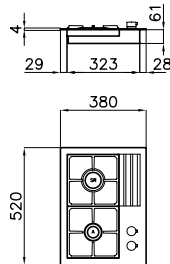
| Caratteristiche | Versione | Sigla | Prezzo € | Disegno Tecnico |
|--|----------|----------|------------|---|
|  <p>AISI 304 spazzolato Griglie in ghisa e coprispartifiamma smaltati Potenza tot. 7.600 W ausiliario: 1.100 W semirapido: 2x1.750 W rapido: 3.000 W</p> <p>Accensione elettrica</p> <p>Valvolatura di sicurezza con termocoppia ad intervento rapido</p> | FT | 7256 032 | € 1.503,00 | <p>Filotop: 620x520 - foro (FT): vedi sito web foro filotop in appoggio (FTS): 600x500</p>  <p>Le quote si riferiscono alla versione d'incasso filotop</p> |
| | FTS | 7256 032 | | |
| <p>Accessori Filotop: 4 (vedi pag. 218)</p> | | | | |
|  <p>AISI 304 spazzolato Griglie in ghisa e coprispartifiamma smaltati Potenza tot. 5.000 W dual AE: 5.000 W</p> <p>Accensione elettrica</p> <p>Valvolatura di sicurezza con termocoppia ad intervento rapido</p> | Q4 | 7278 032 | € 1.045,00 | <p>Q4: 450x520 - foro: 430x480</p>  <p>Predisposizione per i mercati asiatici disponibile a richiesta.</p> |
| | | | | |
| <p>In dotazione: 2 , 4 (vedi pag. 218)</p> | | | | |
| | | | | <p>Note per il fissaggio sul top: vedi a pagina 203</p> |
|  <p>AISI 304 spazzolato Griglie in ghisa e coprispartifiamma smaltati Potenza tot. 2.750 W ausiliario AE: 1.000 W semirapido AE: 1.750 W</p> <p>Accensione elettrica</p> <p>Valvolatura di sicurezza con termocoppia ad intervento rapido</p> | Q4 | 7276 032 | € 1.027,00 | <p>Q4: 380x520 - foro: 360x480</p>  |
| | | | | |
| <p>In dotazione: 4 (vedi pag. 218)</p> | | | | |
| | | | | <p>Note per il fissaggio sul top: vedi a pagina 203</p> |

Un appoggio pentola versatile



Nelle versioni con incasso filotop, è disponibile come elemento accessorio la piastra porta-pentole cod. 9601 742, che moltiplica la superficie di lavoro, salvaguardando il top dal contatto accidentale con le pentole calde. Di serie per le versioni S4000 Domino.



S4000 Line XL

L'EVOLUZIONE DEL PIANO IN LINEA, AD ALTA EFFICIENZA ENERGETICA





Piani cottura nuova generazione risparmio energetico 20%

| Caratteristiche | Versione | Sigla | Prezzo € | Disegno Tecnico |
|-----------------|----------|-------|----------|-----------------|
|-----------------|----------|-------|----------|-----------------|



AISI 304 spazzolato
Griglie in ghisa e coprispartifiamma smaltati
Potenza tot. 9.650 W
ausiliario: 1.100 W
semirapido: 1.750 W

rapido: 3.000 W
tripla corona: 3.800 W
Accensione elettrica
Valvolatura di sicurezza con termocoppia ad intervento rapido

| | | |
|---|-----|----------|
|  | FT | 7284 042 |
|  | FTS | 7284 042 |

€ 1.610,00

Filtop: 1179x465 - foro (FT): vedi sito web
foro filtop in appoggio (FTS): 1162x448

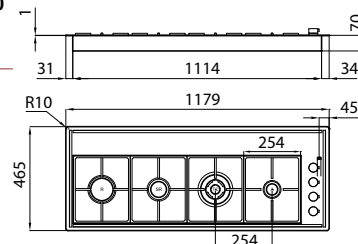



In dotazione: 4x  ,  (vedi pag. 218)



AISI 304 spazzolato
Griglie in ghisa e coprispartifiamma smaltati
Potenza tot. 6.650 W
ausiliario: 1.100 W
semirapido: 1.750 W

tripla corona: 3.800 W
Accensione elettrica
Valvolatura di sicurezza con termocoppia ad intervento rapido

| | | |
|---|-----|----------|
|  | FT | 7285 032 |
|  | FTS | 7285 032 |

€ 1.365,00

Filtop: 925x465 - foro (FT): vedi sito web
foro filtop in appoggio (FTS): 908x448

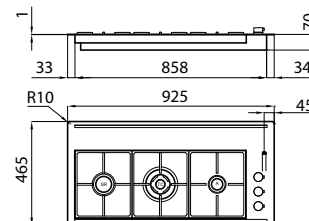

In dotazione: 3x  ,  (vedi pag. 218)



Campione di funzionalità











Line XL si caratterizza per la maggiore profondità del pianale, sul quale sono posizionati eleganti elementi in ghisa. Possono essere inseriti nella parte frontale del piano, o usati come appoggio.

S4000 Line

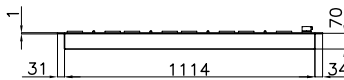
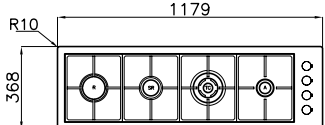
UN CONCEPT LINEARE DI PRATICITÀ

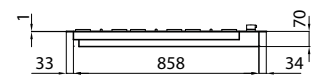
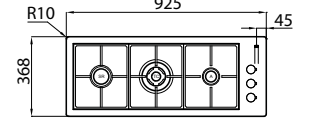

**Piani cottura nuova generazione
risparmio energetico 20%**

| | Caratteristiche | Versione | Sigla | Prezzo € | Disegno Tecnico |
|---|-----------------|---|----------|------------|---|
|  <p>AISI 304 spazzolato Griglie in ghisa e coprispartifiamma smaltati Potenza tot. 9.650 W ausiliario: 1.100 W semirapido: 1.750 W</p> <p>rapido: 3.000 W tripla corona: 3.800 W Accensione elettrica Valvolatura di sicurezza con termocoppia ad intervento rapido</p> <p>In dotazione: 1 Accessori Filotop: 5 (vedi pag. 218)</p> | |  | 7250 042 | € 1.482,00 | <p>Semifilo: 1179x368 - foro: 1162x351 Filotop: 1179x368 - foro (FT): vedi sito web foro filotop in appoggio (FTS): 1162x351</p>   <p>Le quote si riferiscono alla versione d'incasso filotop</p> |
| | |  | 7259 042 | € 1.482,00 | |
| | |  | 7259 042 | | |
|  <p>AISI 304 spazzolato Griglie in ghisa e coprispartifiamma smaltati Potenza tot. 6.650 W ausiliario: 1.100 W</p> <p>semirapido: 1.750 W tripla corona: 3.800 W Accensione elettrica Valvolatura di sicurezza con termocoppia ad intervento rapido</p> <p>In dotazione: 1 Accessori: 5 (vedi pag. 218)</p> | |  | 7286 032 | € 1.303,00 | <p>Filotop: 925x368 - foro (FT): vedi sito web foro filotop in appoggio (FTS): 908x351</p>   |
| | |  | 7286 032 | | |

Elegante manopola metallica

Tutta la serie 4000 è dotata della nuova manopola, elegante ed essenziale. L'accensione è elettrica "sottomanopola", come per tutti i piani cottura Foster. Inoltre, grazie ai nuovi bruciatori, oggi l'accensione è ancora più rapida.



Quadra Angolare

UN ANGOLO COTTURA PERFORMANTE

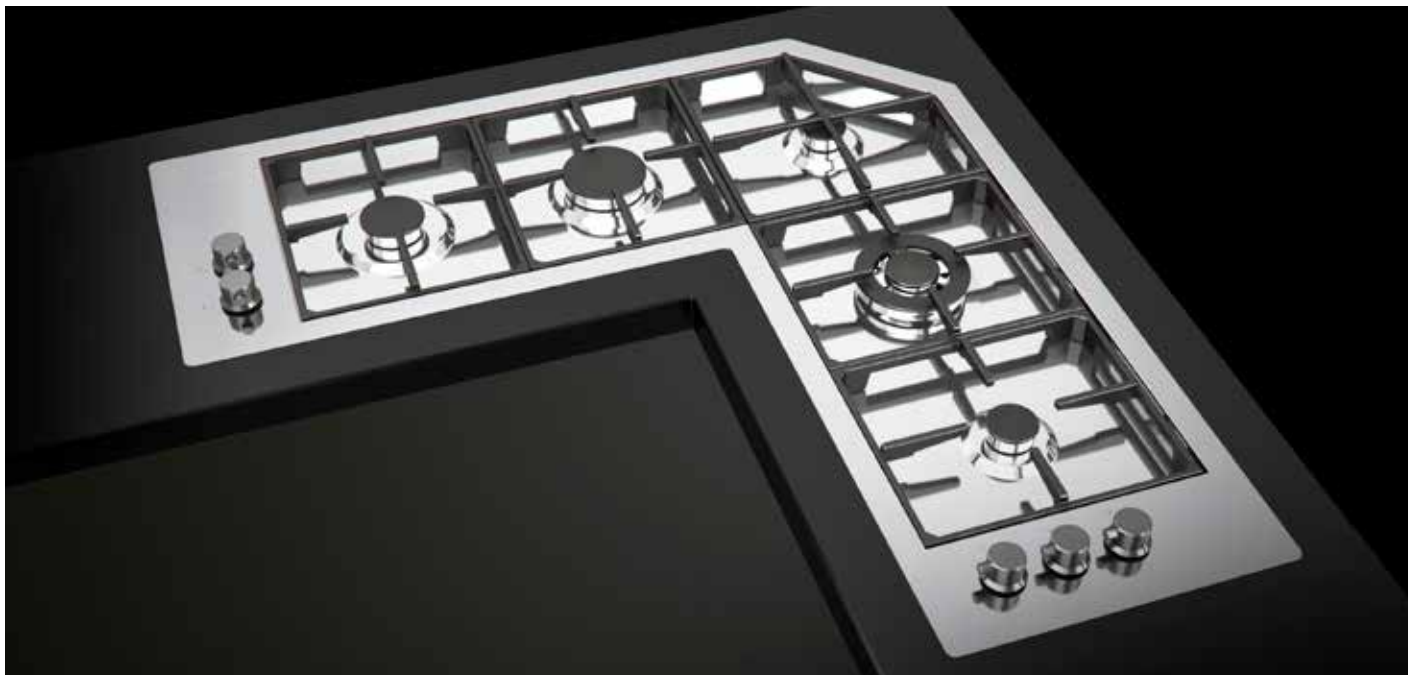

| Caratteristiche | Versione | Sigla | Prezzo € | Disegno Tecnico |
|-----------------|----------|-------|----------|-----------------|
|-----------------|----------|-------|----------|-----------------|

Semifilo: 972x972 - foro: vedi sito web

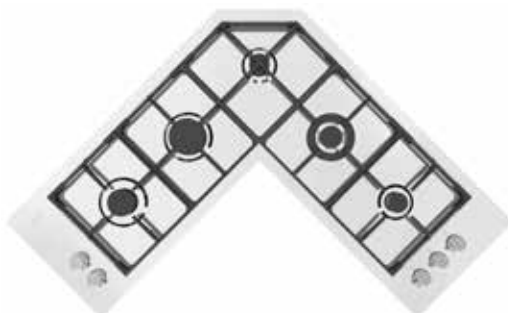

 7235 042

€ 2.591,00

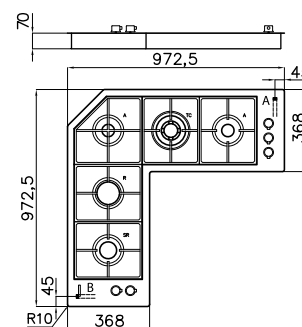

AISI 304 spazzolato
Griglie in ghisa e
coprispartifiamma smaltati
Potenza tot. 9.950 W
ausiliario: 2x1.000 W
semirapido: 1.750 W

rapido: 2.700 W
tripla corona: 3.500 W
Accensione elettrica
Valvolatura di sicurezza
con termocoppia ad
intervento rapido

*L'allacciamento alla rete del gas
deve essere effettuato tramite
entrambi gli ingressi (A e B)*

Accessori: **1** (vedi pag. 218)

PIANI GAS

L'angolo intelligente

Con un'ampia superficie frontale di lavoro, il piano cottura Quadra Angolare consente di utilizzare al meglio l'angolo cucina.





FL

PERFORMANCE ED EFFICIENZA CON STILE

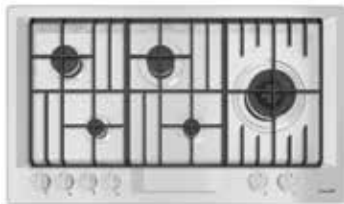
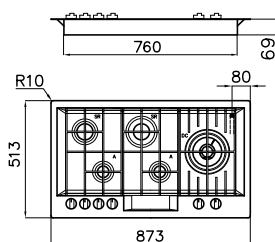

Bruciatori Alta Efficienza
Risparmio energetico 25%

| | Caratteristiche | Versione | Sigla | Prezzo € | Disegno Tecnico |
|---|---|----------|----------|------------|--|
|  | AISI 304 spazzolato Griglie in ghisa e coprispartifiamma smaltati Potenza tot. 10.500 W ausiliario: 2x1.000 W dual AE: 5.000 W semirapido: 2x1.750 W | STD | 7201 032 | € 1.118,00 | Standard: 860x500 - foro: 840x480 Semifilo: 873x513 - foro (FT): vedi sito web Filotop: 873x513 - foro (FT): vedi sito web foro filotop in appoggio (FTS): 860x500  |
| | Accensione elettrica | SF | 7205 032 | € 1.344,00 | |
| | Valvolatura di sicurezza con termocoppia ad intervento rapido | FT | 7206 032 | € 1.344,00 | |
| | | FTS | 7206 032 | € 1.344,00 | |
| In dotazione: 2  Porta wok 9601 727 | versione vintage  | FT | 7206 082 | € 1.477,00 | Le quote si riferiscono alla versione d'incasso filotop |
| | | FTS | 7206 082 | € 1.477,00 | |











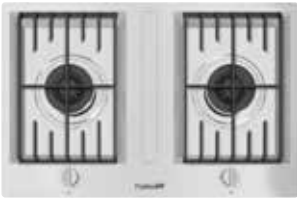

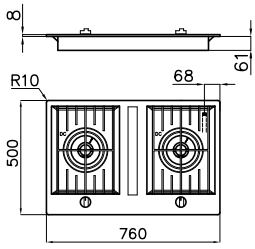

Griglie ultra-piatte

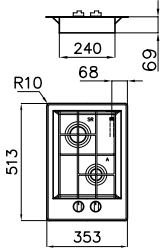
Le stabili griglie in ghisa formano un'unica superficie su cui è possibile spostare le pentole con facilità e in piena sicurezza.

Bruciatore Dual 5kW

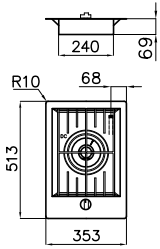
Il piano FL è dotato di un potente bruciatore con 5kW e due corone di fuoco indipendenti, comandate da una doppia manopola.



| | Caratteristiche | Versione | Sigla | Prezzo € | Disegno Tecnico |
|---|---|--|----------|----------|---|
|  | AISI 304 spazzolato Griglie in ghisa e coprispartifiamma smaltati Potenza tot. 10.000 W dual AE: 2x5.000 W Accensione elettrica Valvolatura di sicurezza con termocoppia ad intervento rapido |  | 7203 032 | € 996,00 | Standard: 760x500 - foro: 740x480  |
| | | In dotazione: 2x  | | | |
|  | AISI 304 spazzolato Griglie in ghisa e coprispartifiamma smaltati Potenza tot. 2.750W ausiliario: 1.000 W semi-rapido: 1.750 W Accensione elettrica Valvolatura di sicurezza con termocoppia ad intervento rapido |  | 7209 032 | € 561,00 | Semifilo: 353x513 - foro: 320x480 Filotop: 353x513 - foro (FT): vedi sito web foro filotop in appoggio (FTS): 340x500  |
| | |  | 7208 032 | € 561,00 | |
| | |  | 7208 032 | | |
|  | AISI 304 spazzolato Griglie in ghisa e coprispartifiamma smaltati Potenza tot. 5.000 W dual AE: 5.000 W Accensione elettrica Valvolatura di sicurezza con termocoppia ad intervento rapido |  | 7204 032 | € 622,00 | Semifilo: 353x513 - foro: 320x480 Filotop: 353x513 - foro (FT): vedi sito web foro filotop in appoggio (FTS): 340x500  |
| | |  | 7207 032 | € 622,00 | |
| | |  | 7207 032 | | |
| In dotazione:  | | | | | |



Grazie al versatile bruciatore DUAL, FL domino è un piano cottura completo, anche se con un singolo fuoco. È possibile erogare potenze minime, adatte per una piccola moka, o al contrario fino a 5000 W per cotture wok o per portare l'acqua ad ebollizione in poco tempo.











Nei piani cottura FL il bruciatore DUAL è ancora più versatile, grazie alla doppia manopola di controllo. Le 2 corone di fuoco sono infatti completamente indipendenti.

KE

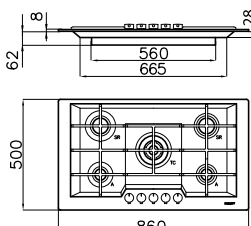
QUALITÀ DI FORMA E SOSTANZA

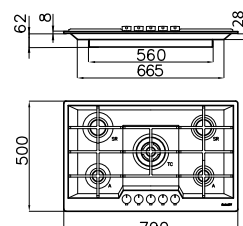

 **Piani cottura nuova generazione risparmio energetico 20%**

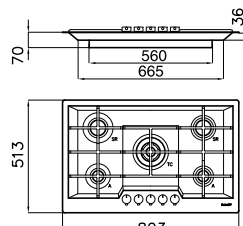







| | Caratteristiche | Versione | Sigla | Prezzo € | Disegno Tecnico | |
|---|---|---|-------------------------------------|------------|--|------------|
|  | AISI 304 spazzolato Griglie in ghisa e coprispartifiamma smaltati Potenza tot. 9.500 W ausiliario: 2x1.100 W semirapido: 2x1.750 W tripla corona: 3.800 W Accensione elettrica Valvolatura di sicurezza con termocoppia ad intervento rapido |  | 7603 032 | € 964,00 | Standard: 860x500 - foro: 840x480  | |
| | | | Accessori: 2 (vedi pag. 218) | | | |
|  | AISI 304 spazzolato Griglie in ghisa e coprispartifiamma smaltati Potenza tot. 9.500 W ausiliario: 2x1.100 W semirapido: 2x1.750 W tripla corona: 3.800 W Accensione elettrica Valvolatura di sicurezza con termocoppia ad intervento rapido |  | 7602 032 | € 941,00 | Standard: 790x500 - foro: 750x480  | |
| | | | Accessori: 2 (vedi pag. 218) | | | |
|  | AISI 304 spazzolato Griglie in ghisa e coprispartifiamma smaltati Potenza tot. 9.500 W ausiliario: 2x1.100 W semirapido: 2x1.750 W tripla corona: 3.800 W Accensione elettrica Valvolatura di sicurezza con termocoppia ad intervento rapido |    | 7600 032 | € 1.189,00 | Semifilo: 803x513 - foro: 770x480 Filtop: 803x513 - foro (FT): vedi sito web foro filtop in appoggio (FTS): 790x500  | |
| | | | | 7601 032 | | € 1.189,00 |
| | | | Accessori: 2 (vedi pag. 218) | 7601 032 | | |

KE Black

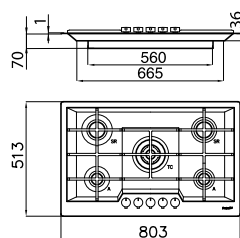
LOOK SPORTIVO E GRINTOSO GRAZIE ALLA FINITURA GUN METAL DI BRUCIATORI E MANOPOLE

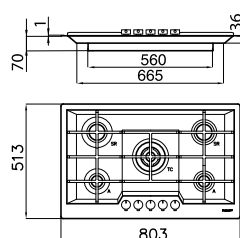

 **Piani cottura nuova generazione risparmio energetico 20%**

| | Caratteristiche | Versione | Sigla | Prezzo € | Disegno Tecnico |
|--|---|--|----------|-------------------|---|
|  | AISI 304 spazzolato Griglie in ghisa, bruciatori gun metal e coprispartifiamma smaltati Potenza tot. 9.500 W ausiliario: 2x1.100 W semirapido: 2x1.750 W tripla corona: 3.800 W Accensione elettrica Valvolatura di sicurezza con termocoppia ad intervento rapido |  FT | 7600 666 | € 1.261,00 | Filotop: 803x513 - foro (FT): vedi sito web foro filotop in appoggio (FTS): 790x500  |
| | |  FTS | 7600 666 | | |
|  | AISI 304 Vintage Griglie in ghisa, bruciatori gun metal e coprispartifiamma smaltati Potenza tot. 9.500 W ausiliario: 2x1.100 W semirapido: 2x1.750 W tripla corona: 3.800 W Accensione elettrica Valvolatura di sicurezza con termocoppia ad intervento rapido |  FT | 7601 082 | € 1.382,00 | Filotop: 803x513 - foro (FT): vedi sito web foro filotop in appoggio (FTS): 790x500  |
| | |  FTS versione vintage  | 7601 082 | | |

Accessori: **2** (vedi pag. 218)

Accessori: **2** (vedi pag. 218)













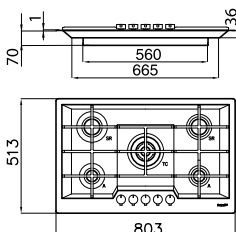

KE Black è disponibile anche nella variante con finitura **Vintage**.

KE PVD

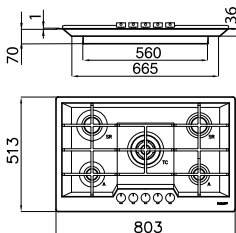
L'ELEGANZA DEL PIANO COTTURA KE, IN NUOVE ESCLUSIVE FINITURE

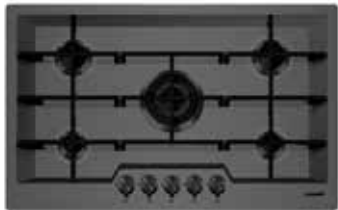

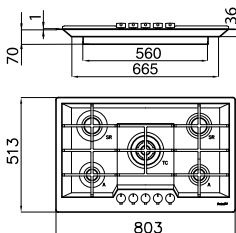
**Piani cottura nuova generazione
risparmio energetico 20%**

| | Caratteristiche | Versione | Sigla | Prezzo € | Disegno Tecnico |
|---|---|---|----------|-------------------|---|
|  | AISI 304 Gold Griglie in ghisa, bruciatori gun metal e coprispartifiamma smaltati Potenza tot. 9.500 W ausiliario: 2x1.100 W semirapido: 2x1.750 W tripla corona: 3.800 W Accensione elettrica Valvolatura di sicurezza con termocoppia ad intervento rapido |  FT | 7601 932 | € 1.934,00 | Filotop: 803x513 - foro (FT): vedi sito web foro filotop in appoggio (FTS): 790x500  |
| | |  FTS | 7601 932 | | |
|  | AISI 304 Copper Griglie in ghisa, bruciatori gun metal e coprispartifiamma smaltati Potenza tot. 9.500 W ausiliario: 2x1.100 W semirapido: 2x1.750 W tripla corona: 3.800 W Accensione elettrica Valvolatura di sicurezza con termocoppia ad intervento rapido |  FT | 7601 866 | € 1.934,00 | Filotop: 803x513 - foro (FT): vedi sito web foro filotop in appoggio (FTS): 790x500  |
| | |  FTS | 7601 866 | | |
|  | AISI 304 Gun Metal Griglie in ghisa, bruciatori gun metal e coprispartifiamma smaltati Potenza tot. 9.500 W ausiliario: 2x1.100 W semirapido: 2x1.750 W tripla corona: 3.800 W Accensione elettrica Valvolatura di sicurezza con termocoppia ad intervento rapido |  FT | 7601 632 | € 1.934,00 | Filotop: 803x513 - foro (FT): vedi sito web foro filotop in appoggio (FTS): 790x500  |
| | |  FTS | 7601 632 | | |

Accessori: **2** (vedi pag. 218)

Accessori: **2** (vedi pag. 218)





Accessori: **2** (vedi pag. 218)

KE Line

LA LINEA IN UN DESIGN LEGGERO E ORIGINALE

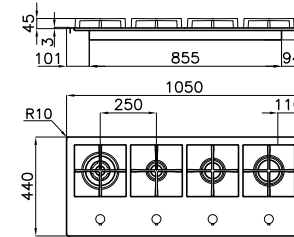

 **Piano cottura nuova generazione risparmio energetico 20%**

| Caratteristiche | Versione | Sigla | Prezzo € | Disegno Tecnico |
|--|---|----------|------------|--|
|  <p>AISI 304 spazzolato Griglie in ghisa e coprispartifiamma smaltati Potenza tot. 9.650 W ausiliario: 1.100 W semirapido: 1.750 W rapido: 3.000 W tripla corona: 3.800 W</p> <p>Accensione elettrica</p> <p>Valvolatura di sicurezza con termocoppia ad intervento rapido</p> |  | 7606 032 | € 1.146,00 | <p>Semifilo: 1050x440 - foro: 1030x420 Filotop: 1050x440 - foro (FT): vedi sito web foro filotop in appoggio (FTS): 1037x427</p>  <p>Le quote si riferiscono alla versione d'incasso semifilo</p> |
| |  | 7607 032 | € 1.146,00 | |
| |  | 7607 032 | | |

Accessori: **2** (vedi pag. 218)

PIANI GAS



Un dettaglio della preziosa manopola e i performanti bruciatori dei piani KE.



KF Marine

SUPER INOX AD ALTA RESISTENZA

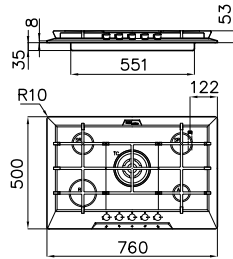
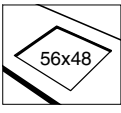

| Caratteristiche | Versione | Sigla | Prezzo € | Disegno Tecnico |
|---|---|--|---|--|
|  | <p>acciaio AISI 316 Griglie in ghisa e coprispartifiamma smaltati Potenza tot. 10.700 W ausiliario: 1.000 W semirapido: 2x1.750 W rapido: 2.700 W tripla corona: 3.500 W</p> |  7666 962 | <p>€ 900,00</p> | <p>Dimensioni: 760x500 - foro: 560x480</p>  |
| <p>Accessori: 2 (vedi pag. 218)</p> | <p>Accensione elettrica</p> <p>Valvolatura di sicurezza con termocoppia ad intervento rapido</p> | <p>Foro incasso stretto</p> |  | <p>Modello non integrabile in top inox</p> |



- Maggiore resistenza:**
- alla salsedine
 - ai detersivi
 - agli acidi degli alimenti

Foster *marine*

ideale per abitazioni al mare

Lavelli Marine vedi pagg. 46-47



RICERCATA ELEGANZA AD ALTA EFFICIENZA



Piani cottura nuova generazione risparmio energetico 20%

| | Caratteristiche | Versione | Sigla | Prezzo € | Disegno Tecnico |
|--|--|----------|----------|----------|---|
| | AISI 304 spazzolato Griglie in ghisa e coprispartifiamma smaltati Potenza tot. 10.150 W ausiliario: 1.100 W semirapido: 3x1.750 W tripla corona: 3.800 W Accensione elettrica Valvolatura di sicurezza con termocoppia ad intervento rapido | | 7610 032 | € 943,00 | Standard: 790x500 - foro: 750x480 |
| | Accessori: 2 (vedi pag. 218) | | | | |
| | AISI 304 spazzolato Griglie in ghisa e coprispartifiamma smaltati Potenza tot. 7.600 W ausiliario: 1.100 W semirapido: 2x1.750 W rapido: 3.000 W Accensione elettrica Valvolatura di sicurezza con termocoppia ad intervento rapido | | 7615 032 | € 788,00 | Standard: 590x500 - foro: 560x480 |

Invaso inclinato

L'invaso inclinato conferisce modernità ed eleganza, oltre ad agevolare la pulizia degli angoli. Una lavorazione molto pregiata che caratterizza entrambe le famiglie KE e KS.



Ceramik

VETROCERAMICA E GAS. UN BINOMIO DI ELEGANZA, PRATICITÀ E SICUREZZA.



Bruciatori Flat
risparmio energetico 20%

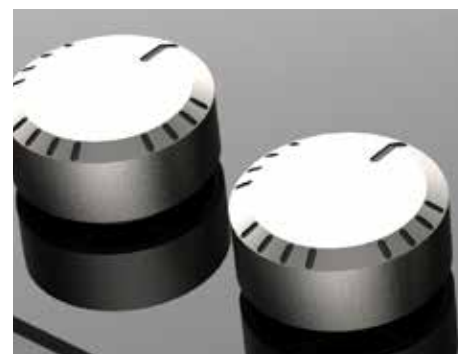









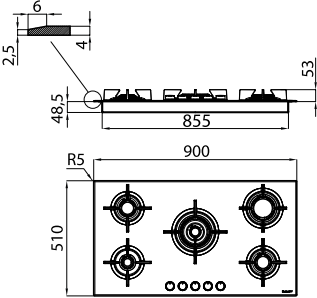

L'elegante bisellatura rende il bordo più snello e si presta anche ad un raffinato inserimento filotop con il piano cottura sporgente di solo 2 mm dal top.

I bruciatori Flat hanno un'altezza ridotta e un design curato che facilita le operazioni di pulizia. Sono impreziositi dalla doppia finitura con un anello in acciaio satinato.

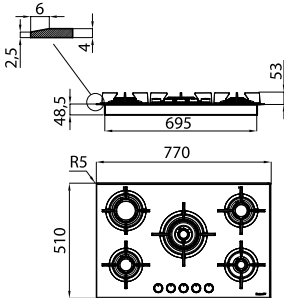
Le manopole sono state progettate per essere perfettamente coordinate con l'estetica dei bruciatori.

Ceramik

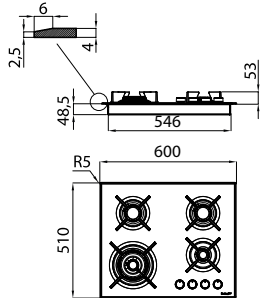
| Caratteristiche | Versione | Sigla | Prezzo € | Disegno Tecnico |
|---|---|----------------------|------------|---|
|  <p>Vetroceramica nero Griglie in ghisa e coprispartifiamma smaltati Potenza tot. 11.500 W ausiliario: 1.000 W semirapido: 2x1.750 W rapido: 3.000 W doppia corona: 4.000 W</p> <p>Accensione elettrica</p> <p>Valvolatura di sicurezza con termocoppia ad intervento rapido</p> <p>Accessori: 2 (vedi pag. 218)</p> |  SF  FT | 7040 632 7040 632 | € 1.235,00 | <p>Dimensioni: 900x510 - foro*: 860x480 foro* (FT): vedi sito web</p>  <p>*ATTENZIONE! il foro incasso non è centrato sul perimetro del piano, controllare la scheda tecnica sul sito prima di procedere al taglio.</p> |
|  <p>Vetroceramica nero Griglie in ghisa e coprispartifiamma smaltati Potenza tot. 11.500 W ausiliario: 1.000 W semirapido: 2x1.750 W rapido: 3.000 W doppia corona: 4.000 W</p> <p>Accensione elettrica</p> <p>Valvolatura di sicurezza con termocoppia ad intervento rapido</p> <p>Accessori: 2 (vedi pag. 218)</p> |  SF  FT | 7039 632 7039 632 | € 1.185,00 | <p>Dimensioni: 770x510 - foro*: 700x480 foro* (FT): vedi sito web</p>  <p>*ATTENZIONE! il foro incasso non è centrato sul perimetro del piano, controllare la scheda tecnica sul sito prima di procedere al taglio.</p> |
|  <p>Vetroceramica nero Griglie in ghisa e coprispartifiamma smaltati Potenza tot. 8.500 W ausiliario: 1.000 W semirapido: 2x1.750 W doppia corona: 4.000 W</p> <p>Accensione elettrica</p> <p>Valvolatura di sicurezza con termocoppia ad intervento rapido</p> <p>Accessori: 2 (vedi pag. 218)</p> |  SF  FT | 7038 632 7038 632 | € 860,00 | <p>Dimensioni: 600x510 - foro*: 560x480 foro (FT): vedi sito web</p>  |

Molto di più di un vetro temprato

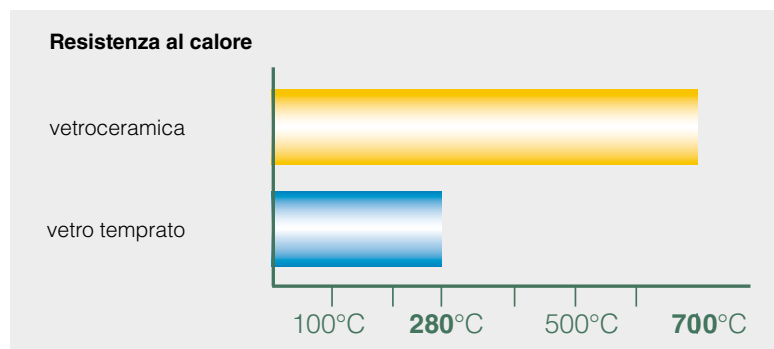











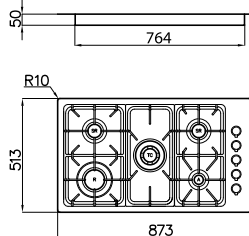

I piani Ceramik hanno il pianale in vitroceramica e non in vetro temprato come la maggior parte dei piani gas di questa tipologia. Questo comporta una resistenza maggiore alle temperature che scongiura ogni possibilità di esplosione del vetro.

Professionale



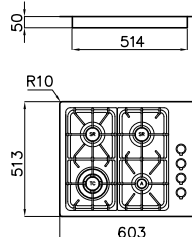



UN EVERGREEN DI PERFORMANCE E PRATICITÀ

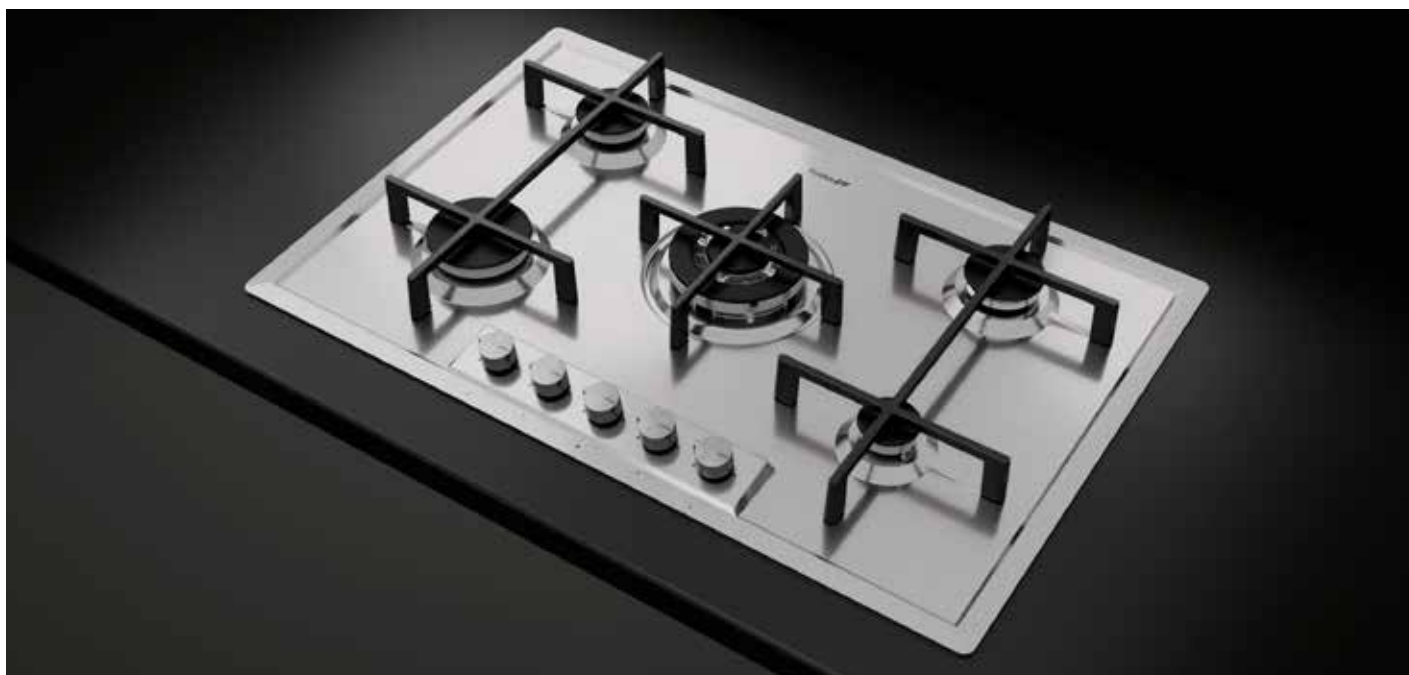

| | Caratteristiche | Versione | Sigla | Prezzo € | Disegno Tecnico |
|---|---|---|----------|------------|--|
|  | AISI 304 spazzolato Griglie in ghisa e coprispartifiamma smaltati Potenza tot. 10.700 W ausiliario: 1.000 W semirapido: 2x1.750 W rapido: 2.700 W tripla corona: 3.500 W Accensione elettrica Valvolatura di sicurezza con termocoppia ad intervento rapido |  | 7055 062 | € 941,00 | Standard: 860x500 - foro: 840x480 Semifilo: 873x513 - foro (FT): vedi sito web Filotop: 873x513 - foro (FT): vedi sito web foro filotop in appoggio (FTS): 860x500  |
| | |  | 7246 062 | € 1.207,00 | |
| | |  | 7245 062 | € 1.201,00 | |
| | |  | 7245 062 | | |
| Accessori: 1 3 (vedi pag. 218) | Le quote perimetrali si riferiscono alla versione d'incasso filotop | | | | |

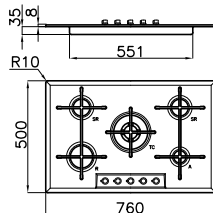
| | | | | | |
|---|---|---|----------|----------|---|
|  | AISI 304 spazzolato Griglie in ghisa e coprispartifiamma smaltati Potenza tot. 8.000 W ausiliario: 1.000 W semirapido: 2x1.750 W tripla corona: 3.500 W Accensione elettrica Valvolatura di sicurezza con termocoppia ad intervento rapido |  | 7053 062 | € 700,00 | Standard: 590x500 - foro: 560x480 Semifilo: 603x513 - foro: 560x480 Filotop: 603x513 - foro (FT): vedi sito web foro filotop in appoggio (FTS): 590x500  |
| | |  | 7244 062 | € 848,00 | |
| | |  | 7243 062 | € 844,00 | |
| | |  | 7243 062 | | |
| Accessori: 1 (vedi pag. 218) | Le quote perimetrali si riferiscono alla versione d'incasso filotop | | | | |

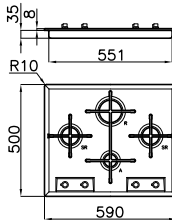

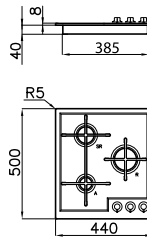
| | Caratteristiche | Versione | Sigla | Prezzo € | Disegno Tecnico |
|--|--|---|--|-----------------|---|
|  <p>Accessori: 2 (vedi pag. 218)</p> | <p>AISI 304 spazzolato Griglie in ghisa e coprispartifiamma smaltati Potenza tot. 10.700 W ausiliario: 1.000 W semirapido: 2x1.750 W rapido: 2.700 W tripla corona: 3.500 W</p> <p>Accensione elettrica</p> <p>Valvolatura di sicurezza con termocoppia ad intervento rapido</p> |  | <p>7067 062</p> <p>56x48</p> <p>Foro incasso stretto</p> | <p>€ 816,00</p> | <p>Standard: 760x500 - foro: 560x480</p>  <p>Modello non integrabile in top inox</p> |
|  | <p>AISI 304 spazzolato Griglie in ghisa e coprispartifiamma smaltati Potenza tot. 7.200 W ausiliario: 1.000 W semirapido: 2x1.750 W rapido: 2.700 W</p> <p>Accensione elettrica</p> <p>Valvolatura di sicurezza con termocoppia ad intervento rapido</p> |  | <p>7066 052</p> | <p>€ 633,00</p> | <p>Standard: 590x500 - foro: 560x480</p>  <p>Modello non integrabile in top inox</p> |
|  | <p>AISI 304 spazzolato Griglie in ghisa e coprispartifiamma smaltati Potenza tot. 5.850 W ausiliario: 1.100 W semirapido: 1.750 W rapido: 3.000 W</p> <p>Accensione elettrica</p> <p>Valvolatura di sicurezza con termocoppia ad intervento rapido</p> |  | <p>7063 052</p> | <p>€ 544,00</p> | <p>Standard: 440x500 - foro: 420x480</p>  |



Piano cottura nuova generazione risparmio energetico 20%

ERGONOMIA E FUNZIONALITÀ



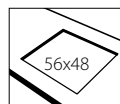

| | Caratteristiche | Versione | Sigla | Prezzo € | Disegno Tecnico |
|--|---|----------|----------|----------|---|
| | AISI 304 spazzolato Griglie in ghisa e coprispartifiamma smaltati Potenza tot. 11.700 W semirap. ridotto: 1.400 W semirapido: 2x1.750 W rapido: 2.800 W doppia corona: 4.000 W Accensione elettrica Valvolatura di sicurezza con termocoppia ad intervento rapido | | 7016 032 | € 567,00 | Dimensioni: 860x500 - foro: 840x480 |
| | Modello non integrabile in top inox | | | | |
| | | | | | |
| | AISI 304 spazzolato Griglie in ghisa e coprispartifiamma smaltati Potenza tot. 10.900 W ausiliario: 1.000 W semirapido: 1.750 W rapido: 2.800 W semirapido rid.: 1.400 W doppia corona: 4.000 W Accensione elettrica Valvolatura di sicurezza con termocoppia ad intervento rapido | | 7015 032 | € 544,00 | Dimensioni: 750x500 - foro: 560x480 |
| | Modello non integrabile in top inox | | | | |
| | | | | | |
| | AISI 304 spazzolato Griglie in ghisa e coprispartifiamma smaltati Potenza tot. 9.550 W ausiliario: 1.000 W semirapido: 1.750 W rapido: 2.800 W doppia corona: 4.000 W Accensione elettrica Valvolatura di sicurezza con termocoppia ad intervento rapido | | 7014 032 | € 436,00 | Dimensioni: 580x500 - foro: 560x480 |
| | Modello non integrabile in top inox | | | | |
| | | | | | |



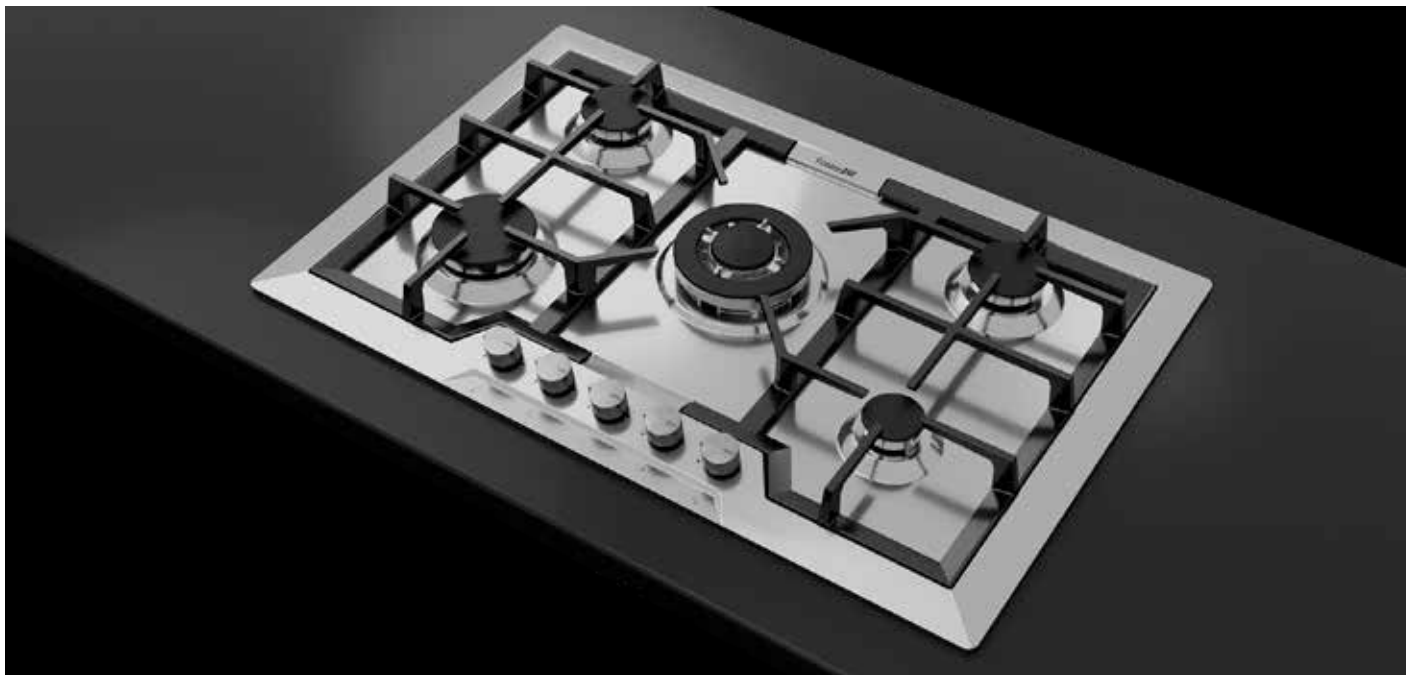

foro incasso stretto

CAMPIONE DI PRATICITÀ

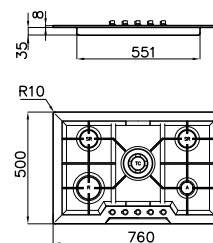
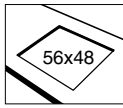

| | Caratteristiche | Versione | Sigla | Prezzo € | Disegno Tecnico |
|--|---|--|----------|----------|--|
|  | AISI 304 spazzolato Griglie in ghisa e coprispartifiamma smaltati Potenza tot. 10.700 W ausiliario: 1.000 W semirapido: 2x1.750 W rapido: 2.700 W tripla corona: 3.500 W Accensione elettrica Valvolatura di sicurezza con termocoppia ad intervento rapido |  | 7064 062 | € 668,00 | Standard: 760x500 - foro: 560x480  |
| | Accessori: 1 (vedi pag. 218) | Foro incasso stretto  | | | |

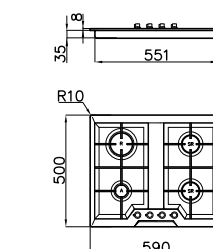
| | | | | | |
|--|--|---|----------|----------|--|
|  | AISI 304 spazzolato Griglie in ghisa e coprispartifiamma smaltati Potenza tot. 7.200 W ausiliario: 1.000 W semirapido: 2x1.750 W rapido: 2.700 W Accensione elettrica Valvolatura di sicurezza con termocoppia ad intervento rapido |  | 7068 042 | € 603,00 | Standard: 590x500 - foro: 560x480  |
| | | | | | |

Pratiche griglie

Particolare delle robuste griglie squadrate del piano Elettra: due sole griglie simmetriche creano l'appoggio per tutti i cinque fuochi del piano.



Angolare

L'ANGOLO IN STILE PROFESSIONALE

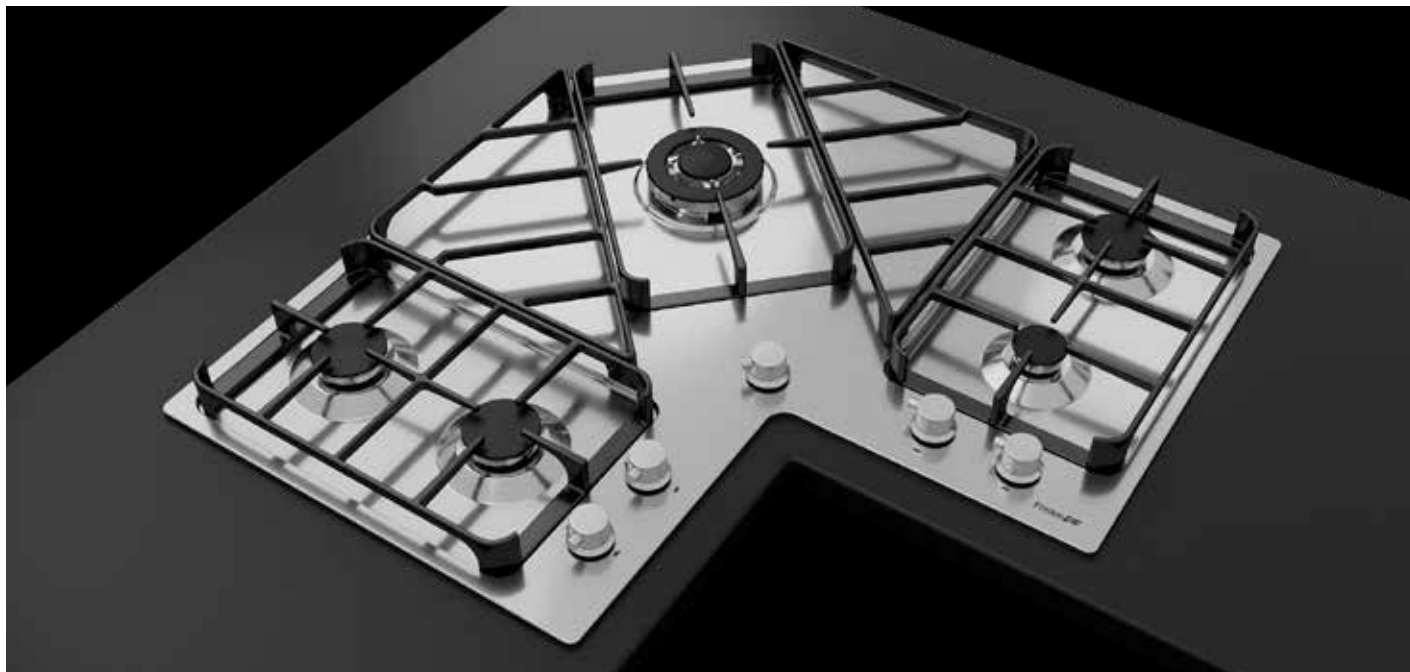

Caratteristiche

Versione

Sigla

Prezzo €

Disegno Tecnico

Bordo std: 830x830 - foro: vedi sito web



7038 052

€ 1.245,00

AISI 304 spazzolato
Griglie in ghisa e
coprispartifiamma
smaltati
Potenza tot. 9.750 W
ausiliario: 1.000 W
semirapido: 3x1.750 W
tripla corona: 3.500 W

Accensione elettrica

Valvolatura di sicurezza
con termocoppia ad
intervento rapido

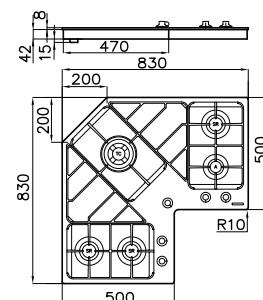

Accessori: **1** (vedi pag. 218)

L'angolo cottura perfetto

Il piano Angolare Foster ottimizza lo spazio dell'angolo grazie alle zone "poggiapentola" in ghisa che danno continuità alle griglie di cottura.





FORNI & COORDINATI

Sistemi modulari ad alta tecnologia.

Forni
S4001
p. 252



Combi Vapore
S4001
p. 252



Micro Combi
S4001
p. 253



Modulo
scaldavivande
S4001
p. 253



Forno FL 90
p. 254



Forno FL 90
Vintage
p. 255



NEW
Abbattitore
Skin
p. 256



NEW
Cassetto
Sottovuoto Skin
p. 258



NEW
Forni
KE
p. 260



Micro-Combi
KE
p. 261



Forni
KE 90
p. 262



Scaldapiatti
inox
p. 262



NEW
Forno
KS
p. 263



Micro+Grill
KS
p. 263



FORNIE
COORDINATI

Caratteristiche

**EASY
Clean**



Smaltatura Easy Clean

La speciale smaltatura rende le superfici del forno perfettamente antiaderenti. La minima porosità delle superfici agevola la pulizia.



Porta Soft Closing

Le cerniere della porta rallentano automaticamente nella parte finale del movimento per una chiusura sempre delicata e senza rumore.

**Guide
Telescopiche**



Guide telescopiche

Favoriscono una migliore distribuzione degli spazi e rendono più agevole l'estrazione delle griglie e delle teglie.

StopSol



Stop Sol

Il particolare trattamento oscurante e riflettente del cristallo esterno dona al forno un'estetica elegante e moderna.

XXL XL



Capacità della camera di cottura

Ai vertici della categoria per capacità garantita. **XL** indica che le versioni hanno capacità maggiore di 60 litri. **XXL** indica i forni con dimensioni fuori standard, ancora più capienti.

**Cotture
Multilivello**



Cotture Multilivello

La speciale ventilazione rende uniforme la temperatura ed evita la commistione dei profumi, permette così la cottura contemporanea di più pietanze.

Termosonda



Termosonda

Verifica in ogni istante la temperatura al cuore del prodotto. Una volta impostata la temperatura di cottura il forno avviserà quando è pronto e disattiverà le resistenze.



Self-Cooking

Ampio menù di ricette e grande controllo della temperatura dei cibi. Grazie alla Termosonda è facile diventare un bravo chef in poco tempo.

**Vetri
removibili**

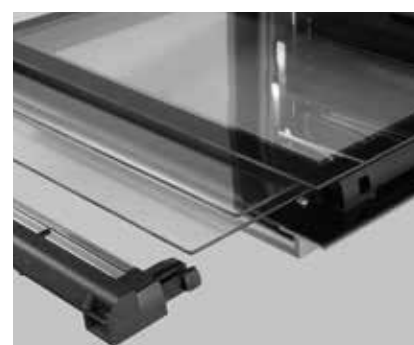

Vetri removibili

I vetri della porta del forno possono essere rimossi per una completa pulizia: i vetri si possono rimuovere con un semplice "click".

Caratteristiche



Classe energetica

Una gamma totalmente in **Classe A++, A+ e A**. Un risultato importante, mirato ad ottimizzare prestazioni e risparmio.

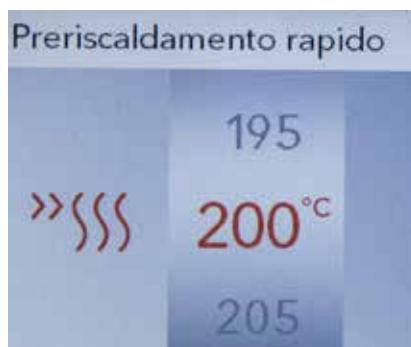

Preriscaldamento rapido

Questa funzione attiva le resistenze e un flusso d'aria calda consentendo di raggiungere 200°C in tempi rapidi.



Porta full glass

In molti modelli l'interno della porta è un'unica superficie di cristallo liscia, estremamente comoda per le operazioni di pulizia.



Finitura anti-touch

Grazie alla speciale protezione, salvaguarda le superfici d'acciaio dalle fastidiose impronte e facilita la pulizia.



Isolamento termico

La ventilazione tangenziale crea un flusso d'aria tra muffola e telaio riducendo la temperatura delle superfici. Il forno così non sottopone i mobili ad elevati sbalzi termici.



Porta con triplo vetro





















Tutti i forni sono dotati di porta con vetri multipli (fino a 3 vetri, 4 per i modelli pirolitici). Questo garantisce temperature contenute della porta e minore dispersione termica.



Funzioni di cottura Forni Multifunzione

L'ampio ventaglio di programmi di cottura disponibili rende i forni Foster performanti in ogni situazione, dalle cotture delicate di pasticceria a quelle intensive per carni o pizza.



- | | |
|---|---|
| <p> Cottura sotto Adatta per riscaldare le vivande.</p> <p> Cottura superiore Cottura per cibi particolarmente delicati e per conservare il calore dopo la cottura.</p> <p> Cottura tradizionale Funzione ideale per tutte le ricette tradizionali, per pane, torte e arrosti.</p> <p> Cottura ventilata La combinazione tra ventilazione e resistenza circolare permette di cucinare assieme diversi tipi di pietanze senza mescolare odori e sapori.</p> <p> Cottura intensiva La resistenza superiore e inferiore insieme alla ventola garantiscono una cottura rapida e uniforme. Ideale per pizza, pane, arrosti, lasagne e torte salate.</p> <p> Ventola + cottura sotto Programma con consumo energetico contenuto, ideale per riscaldare e per alimenti che necessitano di cottura delicata e progressiva.</p> <p> Preriscaldamento rapido Questa funzione attiva le resistenze e un flusso d'aria calda consentendo di raggiungere 200°C in tempi rapidi.</p> <p> Mantenimento calore Ideale per mantenere alla giusta temperatura di servizio le vostre pietanze.</p> <p> Basse temperature Programma per una lenta e delicata cottura a temperature contenute.</p> <p> Cottura Sotto + Ventilata L'azione combinata del calore statico da sotto e quello ventilato della resistenza circolare, per cotture profonde per alimenti di elevato spessore.</p> | <p> Grill centrale Ideale per tostare o gratinare piccole porzioni.</p> <p> Doppio grill Il calore viene prodotto solo dal grill superiore: ideale per tostare, gratinare e dorare alimenti, adatto per carne, pesce e pasta.</p> <p> Cottura sotto + grill Per portare a termine la cottura statica e contemporaneamente gratinare.</p> <p> Cottura sotto + doppio grill Per portare a termine la cottura statica dando la giusta croccantezza alle preparazioni.</p> <p> Ventola + grill Permette una cottura veloce e profonda necessaria per alimenti di grosso volume.</p> <p> Ventola + doppio grill Per le fasi finali della cottura di alimenti come arrosti e pollame, per donare la giusta doratura alle superfici delle pietanze.</p> <p> Scongelamento Consente di scongelare in un terzo del tempo i cibi attraverso la distribuzione uniforme dell'aria a temperatura ambiente.</p> <p> Funzione pizza La combinazione di cottura inferiore, ventilato e grill consente di ottenere una pizza croccante e cucinata in modo eccellente.</p> <p> Grill+Girarrosto La combinazione di grill e girarrosto permette di ottenere la perfetta doratura delle pietanze.</p> <p> Eco Consumo energetico minimo. Utilizza il riscaldamento con convezione forzata e interrompe il funzionamento qualche minuto prima del fine cottura sfruttando il calore residuo.</p> <p> Cottura Sotto + grill + ventola L'uniformità di una cottura ventilata accompagnata accompagnata dalla croccante gratinatura del grill.</p> |
|---|---|

Funzioni di cottura Forni a Gas

- | | |
|---|---|
| <p> Cottura a gas ventilata e statica Il calore del bruciatore a gas può essere o meno accompagnato dalla ventilazione in funzione del risultato da ottenere.</p> | <p> Grill Il calore è generato da una resistenza elettrica dall'alto: ideale per tostare, arrostitire, gratinare e rendere croccanti le preparazioni.</p> |
|---|---|

Funzioni cotture a vapore



Il **forno combinato a vapore S4001** è un vero e proprio gioiello con prestazioni eccellenti e grande versatilità. Rientra nella classe dei **forni gastronomici**, con una sofisticata tecnologia ereditata dalle soluzioni professionali.

La cottura a vapore si combina con quella a convezione dando vita ad un completo set di programmi, per una cucina da vero gourmet.

Qui di seguito le funzioni di cottura specializzate, che si aggiungono ai normali programmi di un forno multifunzione.



Cottura professionale (combinata a vapore)

Sistema misto che unisce aria calda e vapore per ottenere pietanze gustose e succulenti, di derivazione professionale.



Rigenerazione

Un programma apposito per rigenerare le vostre pietanze che utilizza il vapore per restituire la corretta umidità, abbinato ad aria calda tra i 70° e i 130°C.



Vapore puro

Le virtù del vapore per una cottura sana e nutriente. Indicato per tutte le pietanze delicate (verdure, pesce,...) e per tutte le cotture a bassa temperatura (sous vide o vasocotture).

Funzioni di cottura Forno Combi Micro



Quattro differenti soluzioni a microonde.

I modelli **Combi S4001** e **KE** forni completi e performanti, che aggiungono alla cottura micro e al grill anche la cottura ventilata, con un incredibile set di programmi cottura.

Tanta praticità per il **micro+grill KS**, perfettamente abbinabile ai tanti forni in acciaio.

Qui di seguito le funzioni di cottura specializzate, che si aggiungono ai normali programmi di un forno multifunzione.



Cottura con microonde

Ideale per cuocere o riscaldare verdure, riso, pesce, carne e liquidi in modo rapido. Possono essere impostate differenti potenze di funzionamento.



Scongelo automatico

Permette di scongelare impostando il tipo di alimento e il peso.



Microonde ventilato

Il movimento dell'aria generato dalla ventola garantisce una migliore omogeneità delle cotture micro.



Scongelo a tempo

Permette di scongelare impostando la durata del processo



Cottura micro+grill

Metodo di cottura combinato perfetto per lasagne, patate, arrosto e sformati.

S4001





| Modello | Finitura | Sigla | Prezzo € | Disegno Tecnico | | |
|--|-------------------------|---|-------------------------|-----------------|------------|--|
| Serie 4001 multifunzione 60x60 - 65 litri | satinato anti-touch | 7131 054 | € 1.748,00 | | | |
| | | <ul style="list-style-type: none"> • Forno multifunzione 60x60 cm, volume 65 litri • 15 funzioni di cottura • Comandi Touch control • Display con programmazione elettronica intuitiva • Cottura automatica con ricettario programmato • Termosonda per controllo temperatura • Ricette personalizzabili • Funzione preriscaldamento rapido • Raffreddamento con ventilazione tangenziale • 3 guide telescopiche ad estrazione totale • Porta: 3 vetri • Chiusura porta Soft Closing • Cristallo Black Mirror • Interno porta Full Glass • Smaltatura Easy Clean • Protezione resistenza Grill • Blocco comandi di sicurezza • Finitura Anti-touch • Luce forno indipendente • Programmazione in 12 lingue • Modalità Demo • Classe energetica: A++ • Alimentazione: 220-240 V 50-60 Hz • Dotazione di serie: - 2 teglie con smaltatura EasyClean - 1 griglia in acciaio inox | | | | |
| COTTURA SOPRA COTTURA SOTTO COTTURA TRADIZ. COTTURA VENTILATA COTT.VENT. ECO VENTOLA + GRILL VENTOLA + COTT.SOTTO COTTURA INTENSIVA COTT.SOTTO VENT.+GRILL DOPPIO GRILL GRILL CENTRALE DISIDRATAZIONE SCONGELAMENTO FUNZIONE PIZZA CLEAN | | Serie 4001 combinato a vapore 60x46 - 34 litri | satinato anti-touch | 7135 081 | € 2.402,00 | |
| | | <ul style="list-style-type: none"> • Forno combinato a vapore 60x46 cm, volume 34 litri • Immissione controllata del vapore in camera di cottura • 8 funzioni di cottura • Comandi Touch control • Programmazione elettronica Self Cooking • Ricettario programmato modificabile • Termosonda per controllo temperatura • Funzione Sbuffo • Raffreddamento con ventilazione tangenziale • Cicli di pulizia assistita forno e circuito vapore • Porta: 3 vetri • Cristallo Black mirror • Camera di cottura in acciaio inox • Finitura Anti-touch • Luce forno indipendente • Programmazione in 12 lingue • Modalità Demo • Classe energetica: A++ • Alimentazione: 220-240 V 50-60 Hz • Dotazione di serie: 1 teglia 2/3 gastronorm H20 - 1 teglia fonda 2/3 gastronorm H40 con coperchio e griglia di supporto inox - 1 griglia in acciaio inox | | | | |
| COTTURA VENTILATA COTT. VENT. +GRILL COTT. VAPORE 100 GRADI COTT. VAPORE 130 GRADI COTT. VENT. + VAPORE GRILL VENTOLA + GRILL ECO | | | | | | |

S4001

| Modello | Finitura | Sigla | Prezzo € | Disegno Tecnico |
|--|---|----------|------------|---|
| Serie 4001 micro combi 60x46 - 34 litri | satinato anti-touch  | 7136 021 | € 1.991,00 |  |
|  <ul style="list-style-type: none"> • 9 Funzioni di cottura • Potenza microonde 1000 W • Comandi Touch control • Programmazione elettronica Self Cooking • Ricettario programmato modificabile • Funzione scongelamento per tempo e per peso • Raffreddamento con ventilazione tangenziale • Cristallo Black Mirror • Camera di cottura in acciaio inox • Finitura Anti-touch • Luce forno indipendente • Alimentazione: 220-240 V 50 Hz <p>Dotazione di serie: 1 Piatto girevole integrato Ø 32 cm - 1 griglia inox circolare 1 teglia inox 2/3 gastronorm H20 - 1 griglia inox</p> |  | | | |

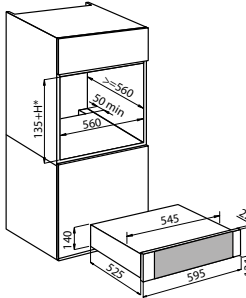
| COTTURA VENTILATA | COTTURA VENTIL.+GRILL | VENTOLA + GRILL | GRILL | SCONGELAM. PER PESO | SCONGELAM. PER TEMPO | COTTURA MICROONDE | MICROONDE + GRILL | MICROONDE +COTT.VENTIL. |
|-------------------|-----------------------|-----------------|-------|---------------------|----------------------|-------------------|-------------------|-------------------------|
| | | | | | | | | |

| | | | | |
|---|---|----------|----------|---|
| Serie 4001 modulo scaldapiatti - 60x14 | satinato anti-touch  | 7138 001 | € 706,00 | <p>Foro da incasso: 560x(140 mm + H incasso forno)</p>  |
|  <ul style="list-style-type: none"> • Modulo 60x14 cm • Carrello estraibile • Interno in acciaio inox e base in cristallo • Temperature: 40 - 70°C • Adatto a riscaldare e mantenere in temperatura gli alimenti <p>• Alimentazione: 220-240 V 50 Hz</p> | | | | |



Allineamento perfetto

Il forno multifunzione alto 60 cm e i forni specializzati alti 46 cm presentano un perfetto allineamento di maniglia e cruscotti prestandosi così ad ogni tipo di abbinamento in verticale ed orizzontale.

FORNIE COORDINATI

FL 90



| Modello | Finitura | Sigla | Prezzo € | Disegno Tecnico |
|---------|----------|-------|----------|-----------------|
|---------|----------|-------|----------|-----------------|

FL Black Mirror - 90
multifunzione 90x48 - 91 litri

BLACK MIRROR 7107 642

€ 1.613,00

Dotazione di serie:
teglia profonda
griglia inox



- Forno multifunzione 90x48 cm, volume lordo 91 litri • 10 funzioni di cottura • Display con programmazione elettronica di inizio-fine cottura e comandi push-pull • Maxi-Grill (abbattibile) • 2 guide telescopiche per agevolare l'estrazione delle teglie • Porta: 3 vetri • Finitura maniglia cromata • Interno porta Full Glass • Cristallo StopSol • Vetro interno porta removibile • Smaltatura Easy Clean • Protezione resistenza Grill • Ventilazione tangenziale • Illuminazione alogena su entrambe le pareti, attiva all'apertura della porta • Interruttore di contatto della porta
- Classe energetica A
- Alimentazione: 220-240V 50-60Hz

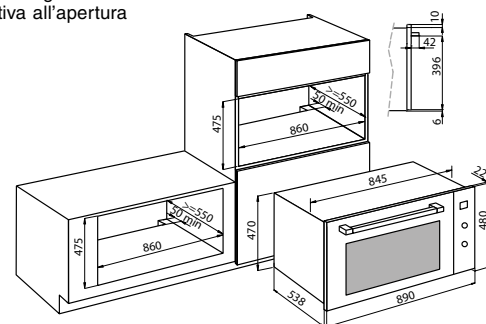

| COTTURA SOTTO | COTTURA TRADIZ. | COTTURA INTENSIVA | COTTURA VENTILATA | GRILL CENTRALE | DOPPIO GRILL | GRILL + COTTURA SOTTO | VENTOLA + MAXI GRILL | VENTOLA + COTTURA SOTTO | SCONGELAMENTO |
|---------------|-----------------|-------------------|-------------------|----------------|--------------|-----------------------|----------------------|-------------------------|---------------|
| | | | | | | | | | |

FL 90 Vintage



| Modello | Finitura | Sigla | Prezzo € | Disegno Tecnico |
|---------|----------|-------|----------|-----------------|
|---------|----------|-------|----------|-----------------|

FL Vintage - 90
multifunzione 90x48 - 91 litri

VINTAGE ANTI-TOUCH  7107 042

€ 1.975,00

Dotazione di serie:
teglia profonda
griglia inox



- Forno multifunzione 90x48 cm, volume lordo 91 litri • 10 funzioni di cottura • Display con programmazione elettronica di inizio-fine cottura e comandi push-pull • Maxi-Grill (abbattibile) • 2 guide telescopiche per agevolare l'estrazione delle teglie • Porta: 3 vetri • Finitura maniglia nera • Interno porta Full Glass • Cristallo StopSol • Vetro interno porta removibile • Smaltatura Easy Clean • Protezione resistenza Grill • Ventilazione tangenziale • Illuminazione alogena su entrambe le pareti, attiva all'apertura della porta • Interruttore di contatto della porta
- Classe energetica A
- Alimentazione: 220-240V 50-60Hz

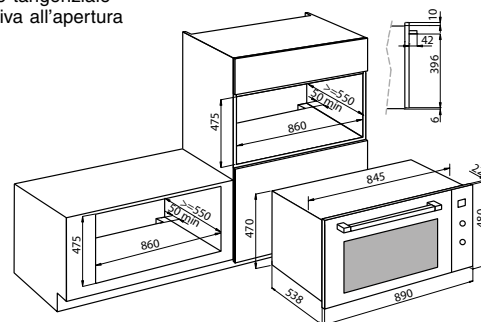

FORNIE COORDINATI

| COTTURA SOTTO | COTTURA TRADIZ. | COTTURA INTENSIVA | COTTURA VENTILATA | GRILL CENTRALE | DOPPIO GRILL | GRILL + COTTURA SOTTO | VENTOLA + MAXI GRILL | VENTOLA + COTTURA SOTTO | SCONGELAMENTO |
|---|---|---|---|---|---|---|---|---|--|
|  |  |  |  |  |  |  |  |  |  |

Skin - abbattitore multifunzione



Il freezer conserva, ma non è idoneo alla surgelazione. L'abbattitore raffredda in un tempo contenuto e permette una micro-cristallizzazione che mantiene inalterate le caratteristiche organolettiche degli alimenti.

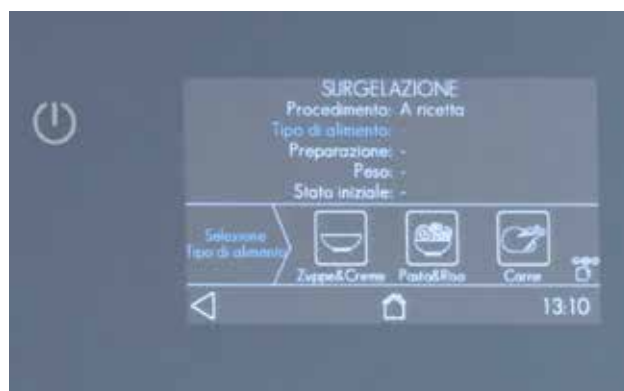

L'abbattitore Skin è semplice ed intuitivo da utilizzare. Semplici domande permettono di impostare tutti i parametri, anche da parte di utilizzatori poco esperti.



La termosonda è un'utile dotazione. Permette di raggiungere un risultato preciso al termine del ciclo di raffreddamento o di cottura.



Abbattitore e sottovuoto non sono utili solo alla conservazione, ma permettono tecniche di cottura innovative che diventano così disponibili anche in ambito domestico.

Skin - abbattitore multifunzione NEW

Modello

Finitura

Sigla

Prezzo €

Disegno Tecnico

Skin abbattitore

multifunzione 60x46 - 40 litri

BLACK MIRROR

2980 601

€ 4.474,00



- Abbattitore da incasso multifunzione 60x46 cm, volume 40 lt
- 11 programmi di funzionamento
- Display Touch TFT
- Programmazione intuitiva assistita
- Interni in acciaio inox • Illuminazione a LED
- Sensori di protezione dai sovraccarichi di temperatura
- Temperature di esercizio: +75°C / -30°C
- Classe Climatica: SN

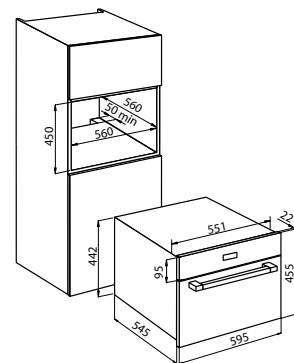

Dotazione di serie:

Sonda al cuore - Vassoio in vetro ad alta tenuta termica - Griglia inox

Alimentazione: 220-240V 50Hz - Potenza max: 300 W

Funzioni abbattitore



Abbattimento temperatura a +3°C

Riduce il tempo di permanenza nel range di temperatura di proliferazione dei batteri e allunga la vita del prodotto. Il rapido raffreddamento blocca inoltre l'evaporazione dell'acqua.



Surgelazione a -18°C

Consente di conservare gli alimenti per diversi mesi. Rimangono intatte le qualità organolettiche, il sapore, l'aroma e l'aspetto degli alimenti mediante la microcristallizzazione dell'acqua, senza lacerazione delle fibre.



Pre-Raffreddamento rapido per l'ottimizzazione dei tempi di esecuzione programmi

Riduce i tempi di esecuzione dei programmi raffreddando delle parti interne dell'apparecchiatura prima dell'utilizzo.



Raffreddamento rapido dei cibi a fine cottura

È possibile accelerare il processo di raffreddamento fino alla temperatura desiderata senza attendere la naturale acclimatazione.



Raffreddamento rapido delle bevande a temperatura di servizio

Questo programma permette di ridurre velocemente la temperatura delle bevande, fino a sei bottiglie.



Conservazione a 0 °C delle preparazioni

È adatta quando si desidera conservare cibi come per esempio carni, pesci e verdure per qualche ora prima della loro preparazione.



Sanificazione del crudo con processo di abbattimento temperatura a -30°C

La cattiva conservazione dei prodotti ittici può causare rischi per la salute per la contaminazione da Anisakis, un parassita che può essere eliminato con una surgelazione a -30°C.



Scongelamento controllato dei prodotti congelati

Porta un alimento dalla temperatura di congelamento a 1÷3°C senza perdere liquidi e senza iniziarne la cottura, evitando la trasformazione delle proteine che si ha con il microonde.



Rigenerazione dei cibi a raggiungimento della temperatura di servizio

Consente di riscaldare un alimento precedentemente cotto e conservato in frigorifero e servirlo in tavola alla temperatura di corretto consumo.



Cottura a bassa temperatura

Cuoce a temperatura costante per un tempo determinato. Grazie alla limitata evaporazione dell'acqua dagli alimenti, permette di mantenere le qualità e la tenerezza dei cibi.



Lievitazione con temperatura e umidità controllate

Crea un microclima a temperatura e umidità controllate e la fermentazione può aver luogo in condizioni ottimali. Programmando la durata è possibile ridurre la quantità di lievito, per prodotti più leggeri e digeribili.



Skin - cassetto per sottovuoto



La cultura del mangiare sano

La tecnica del sottovuoto permette di portare in tavola materie prime di alta qualità, conservate in perfetta igiene e preparate in modo veloce ed economico.



Il vero sottovuoto al 99,9%

La tecnologia "a campana", utilizzata nel professionale, è garanzia di un vuoto spinto (99,9%) non paragonabile a quello di macchine di normale utilizzo domestico (80%).



Marinatura, maturazione e infusione

La funzione Chef Sous Vide "massaggia" gli alimenti con assorbimento di condimenti e profumi. Si replicano processi come la marinatura, la frollatura o l'infusione.



Nessun consumo di cibo

Il set di contenitori proposto come accessorio è tra i pochi adatti ad un livello di vuoto professionale. È utilissimo per mettere sottovuoto alimenti sensibili allo schiacciamento.

Skin - cassetto per sottovuoto NEW

Modello

Finitura

Sigla

Prezzo €

Disegno Tecnico

Skin
cassetto per sottovuoto
60x14

BLACK MIRROR

2981 601

€ 2.482,00



- Cassetto sottovuoto professionale da incasso 14 cm
- Coperchio in vetro temprato con trattamento di sicurezza
- Vasca in acciaio inox AISI 304 - volume 6,5 lt
- Apertura push su guide - apertura max 44 cm
- Sistema blocco cassetto aperto
- Tre livelli di estrazione aria (vuoto fino al 99,9%)
- Barra saldante a doppia fase con tre livelli di saldatura
- Lunghezza barra: 260 mm
- Dimensione max sacchetti 25x35 cm
- Funzione Chef Sous Vide per marinatura, maturazione e infusione
- Modalità per creazione vuoto in contenitori esterni
- Comandi Touch Control
- Durata ciclo conservazione: ca. 1' - in funzione dell'alimento
- Sensore di controllo per un livello di vuoto garantito
- Ciclo di deumidificazione pompa automatico
- elettrovalvola di non ritorno dell'olio pompa
- Potenza max assorbita: 230 W
- Alimentazione: 220-240V 50-60Hz

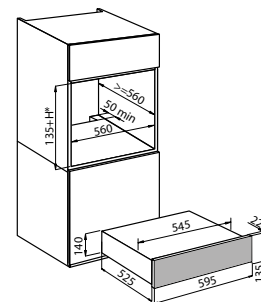

*Foro da incasso:
560x(140 mm + H incasso forno)

accessori

conf. 25 buste per sottovuoto-conservazione 20x30
conf. 25 buste per sottovuoto-conservazione 25x35
conf. 25 buste per sottovuoto-cottura 20x30
conf. 25 buste per sottovuoto-cottura 25x35
kit 3 contenitori per sottovuoto professionale

| Sigla | Prezzo € |
|----------|----------|
| 8502 003 | € 10,00 |
| 8502 004 | € 14,00 |
| 8502 005 | € 15,00 |
| 8502 006 | € 16,00 |
| 8502 007 | € 93,00 |



Sottovuoto per solidi e liquidi

Le macchine "a campana" possono mettere sottovuoto anche i liquidi. Tutte le preparazioni possono essere trattate per allungarne la conservazione.



Saldature a doppia fase

La doppia fase è garanzia di una chiusura perfetta. I tre livelli di saldatura permettono l'utilizzo di buste di vari spessori e di richiudere confezioni di prodotti commerciali.



Tre livelli di vuoto

Non tutte le preparazioni richiedono un vuoto spinto. Si possono impostare tre livelli di aspirazione, o chiudere ermeticamente le confezioni senza estrazione di aria.



Conservare in comode monoporzioni

Con il sottovuoto si risparmia tempo e denaro. Si possono cucinare porzioni multiple, e poi conservarle frazionate per il singolo utilizzo in vasetti monodose.



KE



KE

| Modello | Finitura | Sigla | Prezzo € | Disegno Tecnico |
|---|---|----------|------------|---|
| Serie KE multifunzione 60x60 - 70 litri NEW | satinato anti-touch  | 7142 045 | € 1.095,00 |  |
|  |  <ul style="list-style-type: none"> • Forno multifunzione 60x60 cm, volume 70 litri • 10 funzioni di cottura • Programmazione elettronica di inizio-fine cottura • Porta Soft-Closing • Raffreddamento con ventilazione tangenziale • 3 guide telescopiche • Porta a 3 vetri • Interno porta Full Glass • Vetri porta removibili • Smaltatura Easy Clean • Protezione resistenza Grill • Finitura Anti-touch • Classe energetica: A • Alimentazione: 220-240 V 50-60 Hz Dotazione di serie: 1 teglia e 1 leccarda con smaltatura EasyClean XXL 1 griglia in acciaio inox | | | |

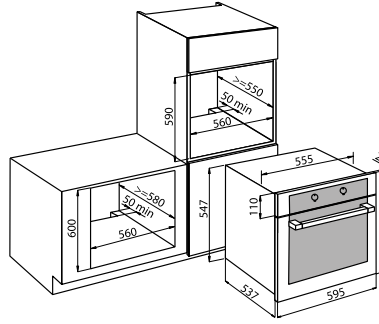
| | | | | | | | | | |
|---------------|-----------------|-------------------|------------------------|-------------------|-----------------------------|--------------|----------------------|---------------------|---------------|
| COTTURA SOTTO | COTTURA TRADIZ. | COTTURA VENTILATA | VENTOLA + DOPPIO GRILL | COTTURA INTENSIVA | COTTURA SOTTO + COTT. VENT. | DOPPIO GRILL | VENTOLA+ COTT. SOTTO | COTT. SOTTO + GRILL | SCONGELAMENTO |
| | | | | | | | | | |

| | | | | |
|---|---|----------|----------|--|
| Serie KE multifunzione 60x60 - 70 litri NEW | satinato anti-touch  | 7141 044 | € 898,00 |  |
|  |  <ul style="list-style-type: none"> • Forno multifunzione 60x60 cm, volume 70 litri • 8 funzioni di cottura • Programmazione elettronica di inizio-fine cottura • Porta Soft-Closing • Raffreddamento con ventilazione tangenziale • 1 guida telescopica • Porta a 3 vetri • Interno porta Full Glass • Vetri porta removibili • Smaltatura Easy Clean • Protezione resistenza Grill • Finitura Anti-touch • Classe energetica: A • Alimentazione: 220-240 V 50-60 Hz Dotazione di serie: 1 teglia e 1 leccarda con smaltatura EasyClean XXL 1 griglia in acciaio inox | | | |

| | | | | | | | |
|---------------|-----------------|-------------------|---------------------|--------------|------------------------|-----------------|----------------------|
| COTTURA SOTTO | COTTURA TRADIZ. | COTTURA INTENSIVA | COTT. SOTTO + GRILL | DOPPIO GRILL | VENTOLA + DOPPIO GRILL | VENTOLA + GRILL | VENTOLA+ COTT. SOTTO |
| | | | | | | | |

| | | | | |
|--|--|----------|------------|---|
| Serie KE micro combi 60x46 - 44 litri | satinato anti-touch  | 7146 022 | € 1.272,00 |  |
|  |  <ul style="list-style-type: none"> • Forno combinato microonde + grill + ventilato 60x46 cm - 44 litri • Microonde 900 W • Resistenze 1750W • Temperatura max 230°C • 10 funzioni di cottura • Display LED con comandi touch-control / manopole • 15 programmi automatici pre-impostati • Finitura antitouch • Interno forno in acciaio inox • Porta: 3 vetri • Ventilazione tangenziale • Impostazione timer 0-90 minuti • Scongelamento automatico per tempo e peso • Piatto girevole ø 36 cm • Interno porta Full Glass • Alimentazione: 230 V 50 Hz Dotazioni di serie: 2 griglie in acciaio inox (grill alto e basso) e 1 teglia rotonda smaltata | | | |

| | | | | | | | | | |
|-------------------|--------------------|-----------------|-------|----------------------|-------------------|---------------------|-------------------------|-----------------------------|-----------------------|
| COTTURA MICROONDE | COTTURA CONVEZIONE | VENTOLA + GRILL | GRILL | VENTOLA + COTT.SOTTO | MICROONDE + GRILL | MICROONDE + VENTOLA | MICROONDE + GRILL VENT. | COTTURA INVENT. + MICROONDE | SCONGELAM. AUTOMATICO |
| | | | | | | | | | |

FORNIE COORDINATI







KE 90

| | | | | |
|---------|----------|-------|----------|-----------------|
| Modello | Finitura | Sigla | Prezzo € | Disegno Tecnico |
|---------|----------|-------|----------|-----------------|

Serie KE 90
multifunzione 90x60 - 103 litri











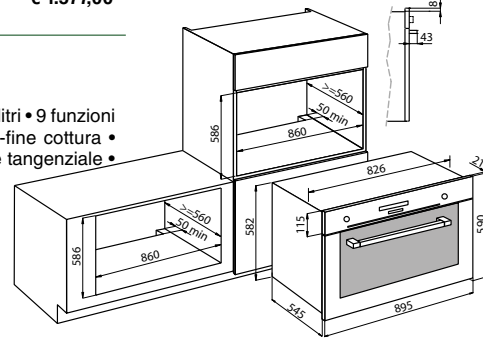

satinato anti-touch  7126 047 € 1.577,00

- Forno multifunzione 90x60 cm, volume lordo 103 litri • 9 funzioni di cottura • Programmazione elettronica di inizio-fine cottura • Display digitale • Raffreddamento con ventilazione tangenziale • Porta a 3 vetri • Interno porta Full Glass • Smaltatura Easy Clean
- Protezione resistenza grill • Luce forno indipendente • Finitura Anti-touch
- Alimentazione: 220-240 V 50-60 Hz

Dotazione di serie: 2 griglie e 1 leccarda smaltata









| | | | | | | | | |
|---|---|---|---|--|---|---|---|---|
| COTTURA SOTTO | COTTURA TRADIZ. | COTTURA INTENSIVA | COTTURA VENTILATA | GRILL CENTRALE | DOPPIO GRILL | VENTOLA + GRILL | COTTURA VENTILATA+SOTTO | ECO |
|  |  |  |  |  |  |  |  |  |

Serie KE 90 GAS
forno ventilato a gas 90x60 - 91 litri







satinato anti-touch  7193 047 € 1.571,00

- Forno gas ventilato 90x60 cm, volume lordo 91 litri • 4 funzioni di cottura • Grill elettrico • Accensione sottomanopola • Valvolatura di sicurezza • Timer di fine cottura • Raffreddamento con ventilazione tangenziale • Porta a 3 vetri
- Smaltatura Easy Clean • Luce forno indipendente • Alimentazione: 220-240 V 50-60 Hz

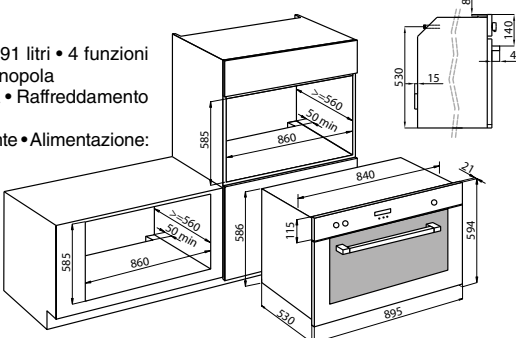
Dotazione di serie: 1 leccarda, 1 griglia e 1 gira-arrosto



| | | | |
|---|---|---|---|
| COTTURA SOTTO | GRILL ELETTRICO | VENTOLA | GIRARROSTO |
|  |  |  |  |

Cassetto Scaldapiatti inox

| | | | | |
|---------|----------|-------|----------|-----------------|
| Modello | Finitura | Sigla | Prezzo € | Disegno Tecnico |
|---------|----------|-------|----------|-----------------|

Cassetto scaldapiatti 60x14 - 24 litri



satinato anti-touch  7104 000 € 748,00

- Apertura push-pull con guide telescopiche
- Interno in acciaio inox con rivestimento antiscivolo
- Riscaldamento a resistenze con regolazione del livello
- Temperatura massima: 85°C
- Capacità massima: 15 kg
- Alimentazione: 220-240V 50-60Hz

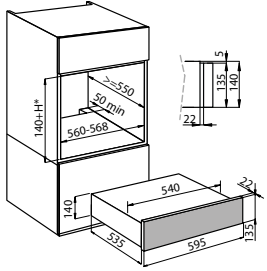

*Foro da incasso: 560x(140 mm + H incasso forno)

KS

| Modello | Finitura | Sigla | Prezzo € | Disegno Tecnico |
|---------|----------|-------|----------|-----------------|
|---------|----------|-------|----------|-----------------|

Serie KS NEW
 multifunzione PP 60x60 - 70 litri









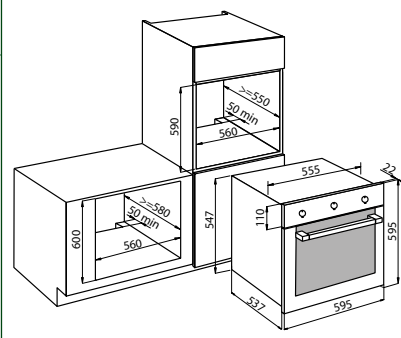

satinato anti-touch  7122 055 € 663,00



- Forno multifunzione 60x60 cm, volume 70 litri • 8 funzioni di cottura • Timer di fine cottura • Raffreddamento con ventilazione tangenziale • Porta a 2 vetri
- Interno porta Full Glass • Vetri porta removibili • Smaltatura Easy Clean • Protezione resistenza Grill • Finitura Anti-touch • Classe energetica: A • Alimentazione: 220-240 V 50-60 Hz

Dotazione di serie: 1 teglia e 1 leccarda con smaltatura EasyClean XXL
 1 griglia in acciaio inox



| COTTURA SOTTO | COTTURA TRADIZ. | COTTURA INTENSIVA | COTT. SOTTO + GRILL | DOPPIO GRILL | VENTOLA + DOPPIO GRILL | VENTOLA + GRILL | VENTOLA+ COTT. SOTTO |
|---|---|---|---|---|---|---|---|
|  |  |  |  |  |  |  |  |

Serie KS
 micro+grill 60x38 - 25 litri





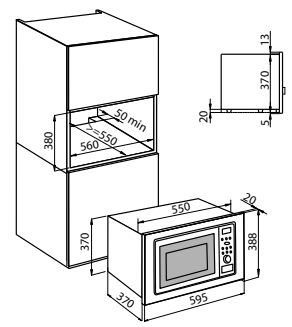

satinato anti-touch  7151 010 € 485,00

- Micro+grill 60x38 cm, volume 25 litri • 5 funzioni di cottura • 8 programmi Self Cooking • 5 livelli potenza fino a 900 W (1000 W Grill) • Programmazione elettronica
- Scongellamento automatico per tempo e peso • Camera di cottura in acciaio inox
- Alimentazione: 230 V / 50 Hz

Dotazione di serie:
 1 griglia
 1 piatto girevole



| COTTURA MICROONDE | GRILL | MICROONDE + GRILL | SCONGELAM. AUTOMATICO | PROGRAMMI PREIMPOSTATI |
|---|---|---|---|---|
|  |  |  |  |  |

FORNIE COORDINATI



CAPPE

Breeze
p. 272



New Sky
p. 273



Ghost
p. 274



S4000
Domino Ghost
p. 276



Domino Air
p. 277



S4001 Special
p. 278



S4001
p. 280



Cilindro
p. 281



FL Slim
p. 282



Stripe
p. 283



KS Lux
p. 284



KS p. 285



Florence
p. 286



Pitagora
p. 287



Amélie
p. 288



New Wing
p. 289



Flat
p. 290



Ad ogni cucina la sua cappa



Cappe a parete

Una vasta scelta di soluzioni che si differenzia per misure, forme, materiali e funzionalità.



Cappe ad isola

Per molti modelli sono disponibili versioni ad isola, installabili in modo versatile grazie ai camini telescopici.



Sistemi di aspirazione a soffitto

Non semplici cappe, ma sistemi di aerazione completi, per migliorare la qualità dell'aria e il comfort.



Cappe da tavolo

Eleganti e minimali, si abbinano con i piani in linea e soluzioni domino, sia a gas che a induzione.



Cappe da incasso

Spariscono nei pensili della cucina, senza perdere la personalità e una grande funzionalità.



Cappe a misura

Progetti su specifica del cliente, sempre con un perfetto abbinamento di design, acciaio e finiture con il top di lavoro.





Illuminazione

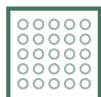

I sistemi di illuminazione a LED, con consumi 10 volte più contenuti e una durata 10 volte superiore, sono volti a creare un adeguato comfort della zona cottura.



Selettore temperatura di colore LED

Consente di modificare la temperatura di colore della luce, potendo così scegliere tra una luce calda, naturale o fredda, in base all'ambiente in cui è inserita.



LED Strip

Una striscia LED che garantisce una zona illuminata estesa ed omogenea, anche nelle soluzioni da tavolo dove la sorgente luminosa è vicina al piano cottura.



Piastre a LED

Pensate per essere l'illuminazione principale dell'ambiente cucina. Elevata efficienza e luminosità per una illuminazione naturale e confortevole con un notevole risparmio energetico.

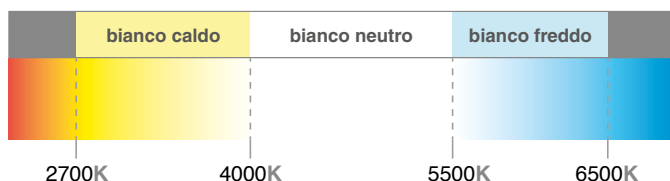

Temperatura di Colore

La tonalità della luce è molto importante per il benessere di un ambiente lungamente vissuto come la cucina. Per questo adottiamo luci prossime alla luce naturale, particolarmente confortevoli.

Potenza silenziosa

Potenza e silenziosità. Due caratteristiche spesso in contrasto fra loro. Le soluzioni Foster hanno una capacità di aspirazione superiore che le rende efficienti e performanti, nel rispetto del comfort acustico.

High performance

Motori caratterizzati da portate superiori alla norma. Sotto il raffinato design si celano potenti strumenti dalle caratteristiche professionali.

Silent System

Motori caratterizzati da una altissima efficienza che determina portate importanti con ridotti consumi e una rumorosità 10 volte inferiore.

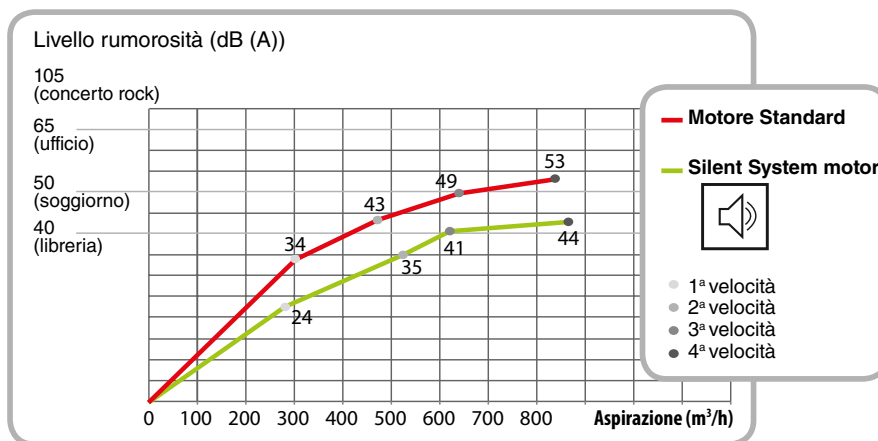

Filtri

Le cappe, nella configurazione base, sono aspiranti e dotate di filtri alveolari antigrasso in alluminio anodizzato multistrato. Con l'aggiunta di filtri a carboni attivi (optional) diventano soluzioni "filtranti".



Avvertenza: i filtri antigrasso possono essere lavati in lavastoviglie per ripristinare l'originale efficienza. Si raccomanda di utilizzare programmi di lavaggio a bassa temperatura (max 40°C) per evitare deformazioni e il viraggio cromatico.



Filtri in acciaio

Nelle configurazioni dove il filtro è a vista, l'elemento filtrante è rivestito in acciaio inox. Una dotazione che migliora l'estetica e ne aumenta la durata nel tempo.

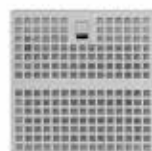

Filtro in acciaio Standard

Ottimo filtraggio grazie ai due strati in acciaio e ben cinque in alluminio.



Filtro in acciaio Hi-class

Estetica elegante ed un potere filtrante maggiorato grazie ai sette strati di alluminio.



Aspirazione perimetrale

I filtri sono nascosti da inserti e l'aspirazione avviene dalle fessure perimetrali. L'estetica risulta più pulita, la pulizia è semplificata, aspirazione e silenziosità risultano migliorate.

Controllo digitale

Comandi elettronici evoluti permettono un controllo perfetto e la migliore efficienza dei motori.

Funzioni aggiuntive come il termometro digitale e il timer contaminuti sono sempre utili per tenere sotto controllo le preparazioni.



Telecomando

I sistemi a soffitto sono dotati di Telecomando per attivare comodamente le funzioni da qualunque posizione.



Funzioni speciali



Funzione Auto Mode

La cappa è dotata di sensori di temperatura e regola la portata di aria in funzione del calore sprigionato dal piano.



Motori orientabili

Motori orientabili a 360° per rispondere a qualsiasi esigenza di installazione.



Spegnimento temporizzato

È possibile impostare lo spegnimento ritardato, prolungando l'aerazione dell'ambiente alla fine dell'utilizzo.



Motori 4 posizioni

Motori a 4 posizioni che permettono una facile installazione.



Avviso pulizia filtri

Tiene sotto controllo le ore di funzionamento e segnala la necessità del lavaggio filtri, per una efficienza ottimale.



Ingombro minimo

Sistemi a soffitto che necessitano di poco spazio. È sufficiente un'intercapedine minore di 20 cm tra soffitto e controsoffitto.



Motore Brushless

Consentono portate d'aria importanti con un consumo energetico ridotto. Hanno inoltre una durata pressoché infinita.



Distanza cappa 50 cm

La cappa può essere inserita a soli 50 cm dal piano, distanza molto inferiore alla norma, con grande efficienza di aspirazione.

Consigli per la scelta

Dimensionamento e installazione sono importanti per ottimizzare efficienza, prestazioni, consumi e silenziosità. Di seguito alcuni consigli pratici per facilitare la scelta.



Dimensionamento della portata

La capacità di aspirazione è rapportata al volume dell'ambiente, per garantire un adeguato ricambio d'aria. La portata è calcolata moltiplicando il volume dell'ambiente per 12 (numero di ricambi d'aria in un'ora).

Per sistemi a soffitto considerare un ricambio di 15 cicli/ora.

$$\begin{array}{c}
 \boxed{\text{m}^2} \quad \times \quad \boxed{\text{h}} \quad \times \quad \boxed{12} \\
 \text{Area cucina} \quad \quad \text{Altezza cucina} \quad \quad \text{n. ricambi aria in un'ora} \\
 \\
 = \\
 \boxed{\text{m}^3/\text{h}} \\
 \text{Portata (capacità di aspirazione necessaria)}
 \end{array}$$

Consigli per la scelta

Posizionamento sul piano di cottura

L'altezza ottimale dal piano cottura è di 65 cm. Nelle cappe a parete con superficie aspirante obliqua si considera l'altezza sulla mediana del filtro di aspirazione.

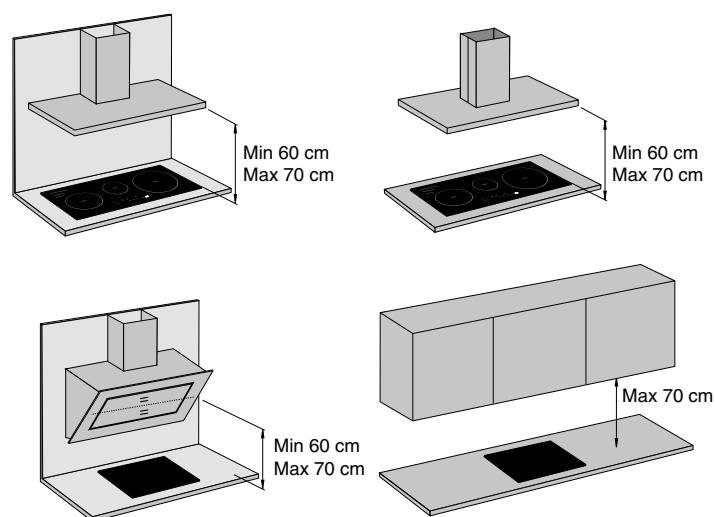
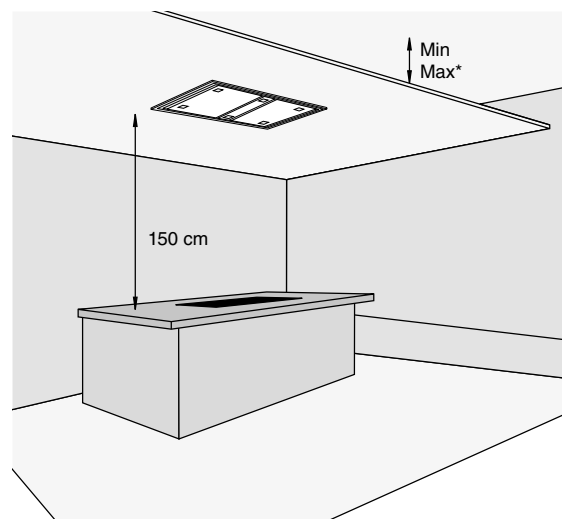

Per i sistemi a soffitto si consiglia di mantenere l'altezza della controsoffittatura ad una altezza non superiore ai 150 cm dal piano di cottura.

Larghezza della cappa

La dimensione deve essere adeguata a quella del piano cottura. Un leggero sovradimensionamento consente un'aspirazione ottimale.

Posizionamento condutture

È bene prevedere condutture dell'aria quanto più possibile dritte. Un percorso tortuoso provocherà una perdita di portata e una conseguente bassa aspirazione. Si raccomanda di non convogliare l'aria in condutture usate per lo scarico fumi.

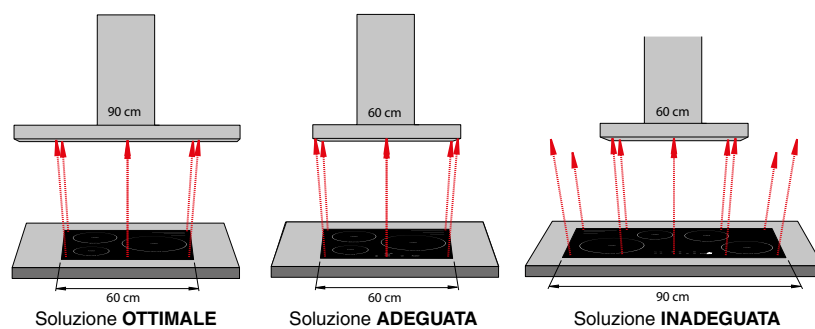

Correnti d'aria

Per un buon funzionamento è opportuno che a cappa sia posta lontano da correnti d'aria.











Condotti aria

I condotti di scarico dei fumi devono avere un diametro interno non inferiore a 120 mm.

Sistemi di canalizzazione

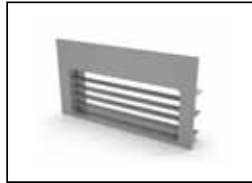
Sistema di canalizzazione Salvaspazio a sezione rettangolare

Per cappe a soffitto **Breeze**, **New Sky** e per il piano aspirante **Foster Milano AIR**, **Milanello AIR** e **Domino AIR**.

| | | | | | |
|--|--|----------------|--|---|-----------------|
|  | 9700 532 tubo bianco a sez. rettangolare 222x89 mm dim: 222x89x1000 mm | € 65,00 |  | 9700 537 riduzione rett / tondo sez. 227x94 mm / ø 158 mm dim: 190x 150x227 mm | € 53,00 |
|  | 9700 533 connettore bianco a sez. rettangolare 227x94 mm dim: 227x94x80 mm | € 34,00 |  | 2541 000 tubo bianco flessibile 3 metri a sezione rettangolare | € 170,00 |
|  | 9700 534 connettore ad angolo 90° orizz. sez. rettangolare: 227x94 mm dim: 288x288x94 mm | € 60,00 |  | 9700 538 valvola di non ritorno ø 148 mm | € 163,00 |
|  | 9700 535 connettore ad angolo 90° vert. sez. rettangolare: 227x94 mm dim: 174x174x227 mm | € 60,00 |  | 9700 539 * griglia per zoccolo colore grigio per zoccoli 100/150 mm dim: 273x150 mm | € 107,00 |
|  | 9700 536 connettore ad angolo 15° orizz. sez. rettangolare: 227x94 mm dim: 233x138x94 mm | € 34,00 |  | 9700 574 * filtro carbone per zoccolo 100-150 mm | € 458,00 |
| | | |  | 9700 575 * ricarica carbone attivo per filtro zoccolo | € 267,00 |

* solo per piano aspirante Milano AIR e cappe Domino AIR e Ghost.

Sistema di canalizzazione Salvaspazio a sezione circolare

Per cappe a isola, a parete e da incasso, cappe da tavolo **Ghost**.

| | | |
|--|---|-----------------|
|  | 9700 602 canalizzazione flessibile silenziante 10 mt. - ø 120 mm | € 161,00 |
| | 9700 603 canalizzazione flessibile silenziante 10 mt. - ø 150 mm | € 173,00 |

Breeze

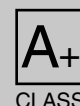

| | Sigla | Prezzo € | Disegno Tecnico |
|--|-------|----------|-----------------|
|--|-------|----------|-----------------|

Breeze inox

2537 001
100 cm

€ 1.855,00



Selettore temperatura di colore LED
è possibile modificare la temperatura di colore della luce, potendo così scegliere tra una luce calda, naturale o fredda, in base all'ambiente in cui è inserita.

Cappa aspirante a soffitto
Finitura: **acciaio inox**
Telecomando incluso
3 filtri antigrasso
4 velocità d'esercizio
Illuminazione 2 LED strip
(2.700/4.000/5.500 kelvin)
Aspirazione perimetrale
Spegnimento automatico differito
Portata: **930 m³/h**
Foro espulsione aria: 230x80 mm

Potenza motore: 85 W
Tipo motore: silence plus
Motore ruotabile a 360°
Easy fix
Classe energetica: A+
Distanza soffitto-controsoffitto:
min 200 mm - max 280 mm

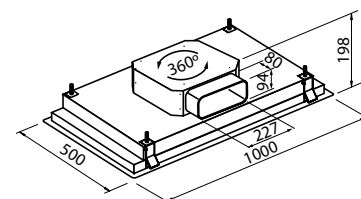

foro incasso: 473 x 970 mm

Opzione modalità filtrante non disponibile

accessori:

sistemi di canalizzazione fumi e kit silenzianti, vedi pag. 271

Breeze white

2537 101
100 cm

€ 2.038,00



Selettore temperatura di colore LED
è possibile modificare la temperatura di colore della luce, potendo così scegliere tra una luce calda, naturale o fredda, in base all'ambiente in cui è inserita.

Cappa aspirante a soffitto
Finitura: **acciaio verniciato bianco**
Telecomando incluso
3 filtri antigrasso
4 velocità d'esercizio
Illuminazione 2 LED strip
(2.700/4.000/5.500 kelvin)
Aspirazione perimetrale
Spegnimento automatico differito

Portata: **930 m³/h**
Foro espulsione aria: 230x80 mm
Potenza motore: 85 W
Tipo motore: silence plus
Motore ruotabile a 360°
Easy fix
Classe energetica: A+
Distanza soffitto-controsoffitto:
min 200 mm - max 280 mm

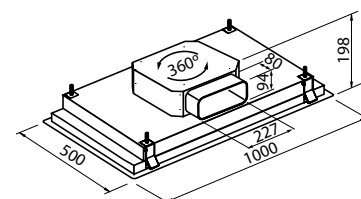

foro incasso: 473 x 970 mm

Opzione modalità filtrante non disponibile

accessori:

sistemi di canalizzazione fumi e kit silenzianti, vedi pag. 271

New Sky

CLASS

| | Sigla | Prezzo € | Disegno Tecnico |
|--|-------|----------|-----------------|
|--|-------|----------|-----------------|

New Sky 100 inox

2522 100
100 cm

€ 1.586,00



Cappa aspirante a soffitto
 Finitura:
 acciaio satinato
Telecomando incluso
 2 filtri antigrasso
 4 velocità d'esercizio
Aspirazione perimetrale
Motore brushless
 Spegnimento automatico differito
Motore ruotabile a 360°

Portata: **930 m³/h**
 Foro espulsione aria: 230x80 mm
 Potenza motore: 85 W
Classe energetica: A+

Distanza soffitto-controsoffitto:
 min 200 mm / max 280 mm

Opzione modalità filtrante non disponibile

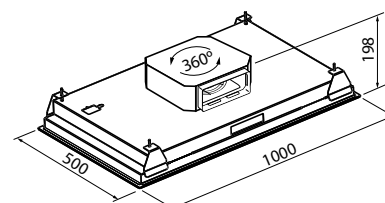

foro incasso: 473 x 970 mm

**accessori:**

sistemi di canalizzazione fumi e kit silenzianti, vedi pag. 271

New Sky 100 bianco

2522 110
100 cm

€ 1.717,00



Cappa aspirante a soffitto
 Finitura:
 acciaio verniciato bianco
Telecomando incluso
 2 filtri antigrasso
 4 velocità d'esercizio
Aspirazione perimetrale
Motore brushless
 Spegnimento automatico differito
Motore ruotabile a 360°

Portata: **930 m³/h**
 Foro espulsione aria: 230x80 mm
 Potenza motore: 85 W
Classe energetica: A+

Distanza soffitto-controsoffitto:
 min 200 mm / max 280 mm

Opzione modalità filtrante non disponibile

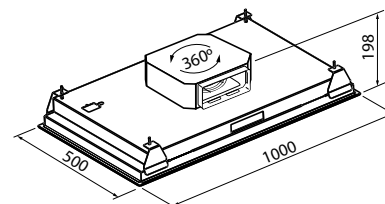

foro incasso: 473 x 970 mm

**accessori:**

sistemi di canalizzazione fumi e kit silenzianti, vedi pag. 271



Ghost

Perfettamente a scomparsa nel piano di lavoro, le cappe Ghost **combinano funzionalità e prestazioni con un design pulito ed essenziale di grande classe.**

La versione 120 è stata progettata per un perfetto abbinamento con le tante soluzioni in linea a gas e induzione.

Ghost

| | | |
|-------|----------|-----------------|
| Sigla | Prezzo € | Disegno Tecnico |
|-------|----------|-----------------|

Ghost 90 Filotop



2451 090

€ 3.185,00



Foro per installazione filotop

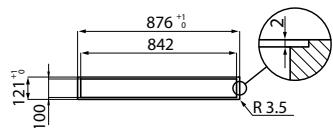

Cappa da tavolo per inserimento filotop

Finitura:

acciaio satinato AISI 304 - vetro nero

Comandi elettronici Touch

2 Filtri antigrasso in alluminio anodizzato

4 velocità d'esercizio

Illuminazione LED Strip (5W - 4.200 kelvin)

Spegnimento automatico differito

Avviso pulizia filtri

Funzionamento filtrante opzionale

Portata: **760 m³/h**

Altezza dal piano: 300 mm

Dimensioni sul piano: 875x120 mm

Foro incasso:

- installazione sopratop: 842x100 mm

- installazione filotop: v. disegno

Foro espulsione aria: Ø 120/150 mm

Potenza motore: 275 W

Classe energetica: A

Nota: Il motore può essere posizionato frontalmente, sul retro della cappa e in modalità remota con l'apposito kit opzionale.

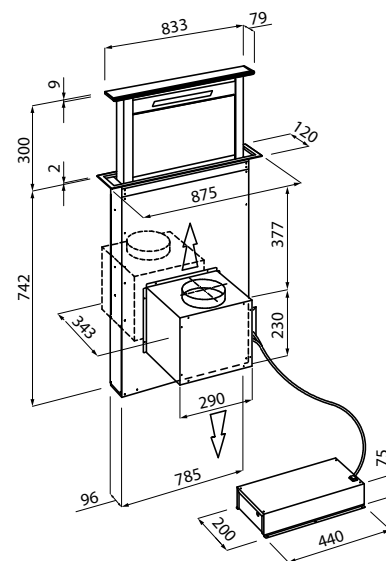

Ghost 120 Filotop



2451 120

€ 3.451,00



Foro per installazione filotop

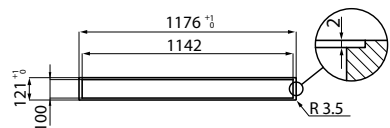

Cappa da tavolo per inserimento filotop

Finitura:

acciaio satinato AISI 304 - vetro nero

Comandi elettronici Touch

2 Filtri antigrasso

4 velocità d'esercizio

Illuminazione LED Strip (9W - 4.200 kelvin)

Spegnimento automatico differito

Avviso pulizia filtri

Funzionamento filtrante opzionale

Portata: **800 m³/h**

Altezza dal piano: 300 mm

Dimensioni sul piano: 1175x120 mm

Foro incasso:

- installazione sopratop: 1142x100 mm

- installazione filotop: v. disegno

Foro espulsione aria: Ø 120/150 mm

Potenza motore: 275 W

Classe energetica: A

Nota: Il motore può essere posizionato frontalmente, sul retro della cappa e in modalità remota con l'apposito kit opzionale.

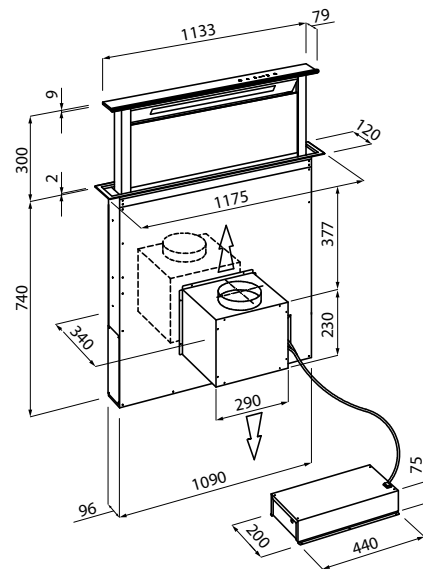

Schemi di installazione con kit motore remoto

Le parti in rosso nel disegno costituiscono un kit per l'installazione del motore in modalità remota, fino ad una distanza di 5 metri.

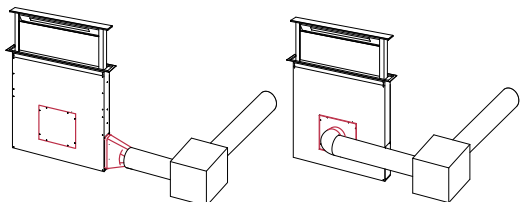

accessori:

| | Sigla | Prezzo € |
|---|----------|----------|
| kit 2 filtri carbone | 9700 460 | € 78,00 |
| kit installazione motore remoto | 9700 459 | € 219,00 |
| sistemi di canalizzazione fumi e kit silenzianti, vedi pag. 271 | | |

S4000 Domino Ghost



| Sigla | Prezzo € | Disegno Tecnico |
|-------|----------|-----------------|
|-------|----------|-----------------|

S4000 Domino Ghost



2451 000

€ 2.700,00

Cappa da tavolo
 Finitura:
acciaio satinato AISI 304 - vetro nero
Comandi elettronici Touch
Aspirazione sui due lati
 1 Filtro antigrasso
 4 velocità d'esercizio
 Spegnimento automatico differito
 Avviso pulizia filtri
 Funzionamento filtrante opzionale

Portata: **640 m³/h**
 Altezza dal piano: regolabile 180-300 mm
 Dimensioni sul piano: 520x120 mm
 Foro incasso: 490x104 mm
 Foro espulsione aria: Ø 120/150 mm
 Potenza motore: 275 W
 Classe energetica: B

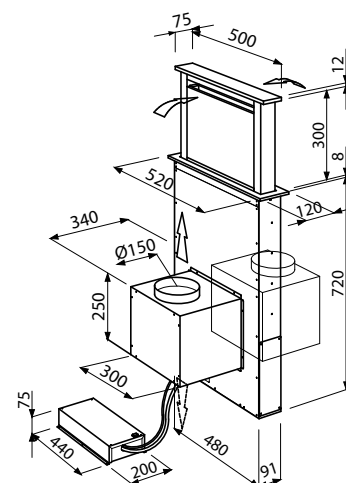

Le cappe Ghost offrono una grande versatilità di installazione: il motore può essere posizionato frontalmente, sul retro della cappa e in modalità remota con l'apposito kit opzionale (vedi disegni a fianco).

Schemi di installazione con kit motore remoto

Le parti in rosso nel disegno costituiscono un kit per l'installazione del motore in modalità remota, fino ad una distanza di 5 metri.

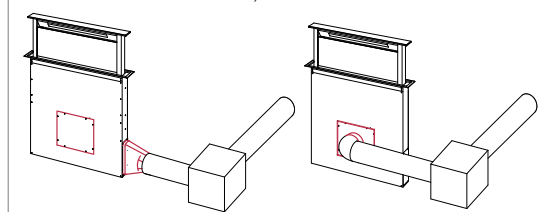

accessori:

| | Sigla | Prezzo € |
|---------------------------------|----------|----------|
| kit 2 filtri carbone | 9700 450 | € 78,00 |
| kit installazione motore remoto | 9700 459 | € 219,00 |

Domino Air



| Modello | Sigla | Prezzo € | Disegno Tecnico |
|---------|-------|----------|-----------------|
|---------|-------|----------|-----------------|

Foster Domino Air  

| | | | |
|--------|----------|------------|--|
| Domino | 2455 000 | € 2.073,00 | |
|--------|----------|------------|--|



Cappa da tavolo
 Finitura:
vetro nero
Comandi elettronici Touch
 1 Filtro antigrasso in acciaio inox
 4 velocità d'esercizio
 Spegnimento automatico differito
 Funzionamento filtrante opzionale
 Avviso saturazione filtri

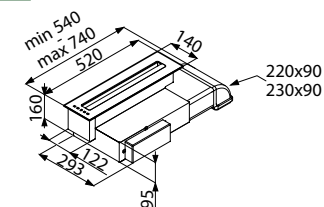

Portata: **490 m3/h**
 Dimensioni sul piano: 140 x 520 mm
 Foro incasso Q4: 126 x 490
 Foro incasso FT: vedi sito web
 Foro espulsione aria: 220 x 90 mm
 Potenza motore: 190 W
 Classe energetica: B

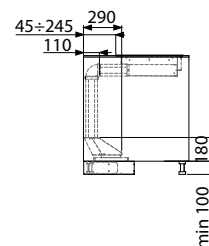

 **Non utilizzabile in abbinamento con piani cottura a gas.**

Articolo ad esaurimento



| accessori: | Sigla | Prezzo € |
|---|----------|----------|
| filtro carbone per zoccolo da 100/150 mm | 9700 574 | € 458,00 |
| ricarica carboni attivi per filtro zoccolo | 9700 575 | € 267,00 |
| sistemi di canalizzazione fumi e kit silenzianti, vedi pag. 271 | | |

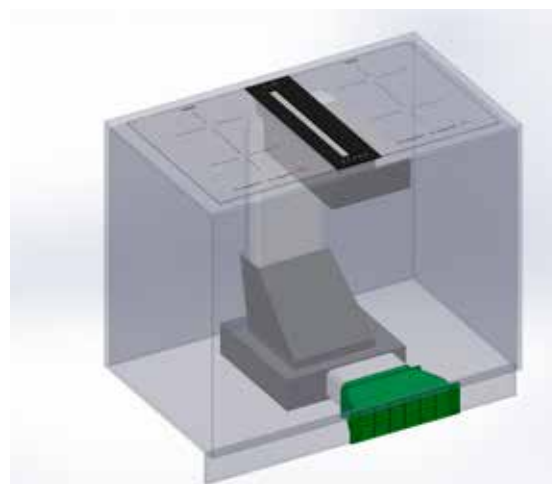

Schema di installazione della cappa Domino Air in modalità filtrante con filtro zoccolo a carboni attivi.



| | misura mm | sigla | Prezzo a partire da | Disegno Tecnico |
|--|-----------|-------|---------------------|-----------------|
|--|-----------|-------|---------------------|-----------------|

S4001 Special - isola

| | | | |
|-------------|----------|------------|--|
| 1201 - 1500 | 2442 150 | € 5.247,00 | |
| 1501 - 2100 | 2442 210 | € 5.470,00 | |
| 2101 - 3000 | 2442 300 | € 5.761,00 | |

Sistema di cappe aspiranti con camino telescopico e con lunghezza personalizzabile.

Finitura:
acciaio satinato AISI 304
Motore Brushless - High Performance
 Comandi elettronici Minimal
 2 filtro antigrasso
 4 velocità d'esercizio

Illuminazione: con **punti luce LED 1W** (5.600 Kelvin) vedi tabella
Aspirazione perimetrale
 Spegnimento automatico differito
 Funzionamento filtrante opzionale
 Tiranti telescopici in tubolare $\varnothing 28 / 25$ mm
 4 sportelli aspiranti (120 cm) in posizione centrale

Camino in posizione centrale.
 Portata: **700 m³/h**
 Altezza camino: 810 - 1220 mm
 Foro espulsione aria: $\varnothing 120/150$ mm
 Potenza motore: 160 W

Classe energetica: vedi tabella

| Lunghezza | N. punti luce LED | Classe energetica |
|-------------|-------------------|-------------------|
| 1201 - 1500 | 18 | A |
| 1501 - 2100 | 24 | A |
| 2101 - 3000 | 30 | A |

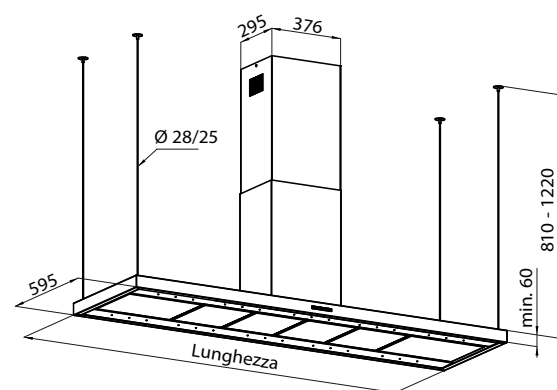

opzioni, con sovrapprezzo su richiesta:

- Barra portamestoli
- Mensolone inox (H. min 30 mm)
- Tiranti con cavetti in acciaio $\varnothing 3$ mm*
- Finitura acciaio Vintage
- Camino decentrato
- Camino sagomato per tetto inclinato
- Lato cappa fuori-squadro
- Tiranti tubolari fissi $\varnothing 10$ mm
- Staffe inox a scomparsa per sostegno cappa parete
- Profondità maggiorata corpo cappa

* non compatibile con mensolone inox.



accessori:

| | Sigla | Prezzo € |
|---|----------|----------|
| kit filtro carbone - Long Life | 9700 001 | € 114,00 |
| sistemi di canalizzazione fumi e kit silenzianti, vedi pag. 271 | | |

| misura | sigla | Prezzo a partire da | Disegno Tecnico |
|--------|-------|---------------------|-----------------|
|--------|-------|---------------------|-----------------|

S4001 Special - parete

| | | |
|-------------|----------|------------|
| 1201 - 1500 | 2440 150 | € 3.901,00 |
| 1501 - 2100 | 2440 210 | € 4.235,00 |
| 2101 - 3000 | 2440 300 | € 4.570,00 |

Sistema di cappe aspiranti con camino telescopico e con lunghezza personalizzabile.

Finitura:

acciaio satinato AISI 304
Motore Brushless - High Performance
 Comandi elettronici Minimal
 2 filtro antigrasso
 4 velocità d'esercizio

Illuminazione: con **punti luce LED 1W** (5.600 Kelvin) vedi tabella

Aspirazione perimetrale
 Spegnimento automatico differito
 Funzionamento filtrante opzionale
 Tiranti telescopici in tubolare $\varnothing 28 / 25$ mm
 4 sportelli aspiranti (120 cm) in posizione centrale

Camino in posizione centrale
 Portata: **700 m³/h**
 Altezza camino: 630 - 1050 mm
 Foro espulsione aria: $\varnothing 120/150$ mm
 Potenza motore: 160 W

Classe energetica: vedi tabella

| Lunghezza | N. punti luce LED | Classe energetica |
|-------------|-------------------|-------------------|
| 1201 - 1500 | 9 | A+ |
| 1501 - 2100 | 12 | A+ |
| 2101 - 3000 | 15 | A |

opzioni, con sovrapprezzo su richiesta:

- Barra portamestoli
- Mensolone inox (H. min 30 mm)
- Tiranti con cavetti in acciaio $\varnothing 3$ mm*
- Finitura acciaio Vintage
- Camino decentrato
- Camino sagomato per tetto inclinato
- Lato cappa fuori-squadro
- Tiranti tubolari fissi $\varnothing 10$ mm
- Profondità maggiorata corpo cappa
- Staffe inox a scomparsa per sostegno

* non compatibile con mensolone inox.

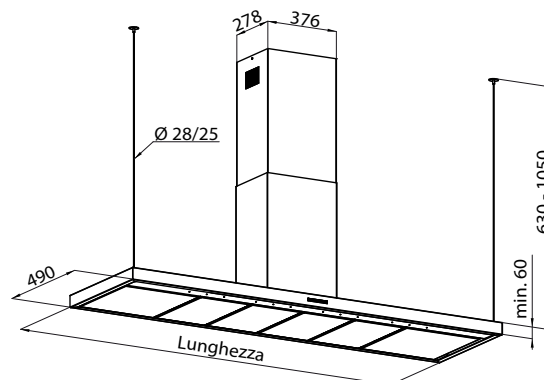

accessori:

| accessori: | Sigla | Prezzo € |
|---|----------|----------|
| kit filtro carbone - Long Life * | 9700 001 | € 114,00 |
| sistemi di canalizzazione fumi e kit silenzianti, vedi pag. 271 | | |

Tipologie di tiranti



Fissaggio opzionale con cavetti d'acciaio $\varnothing 3$ mm.



Fissaggio standard con tubolari telescopici $\varnothing 28/25$ mm



Fissaggio opzionale con tiranti tubolari $\varnothing 10$ mm

Finiture



Finitura spazzolata

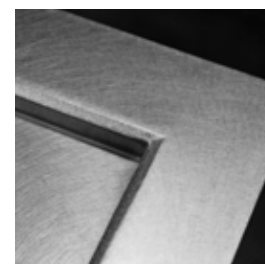

Finitura Vintage

Nell'immagine a fianco cappa S4001 a parete con mensolone inox, e camino decentrato.

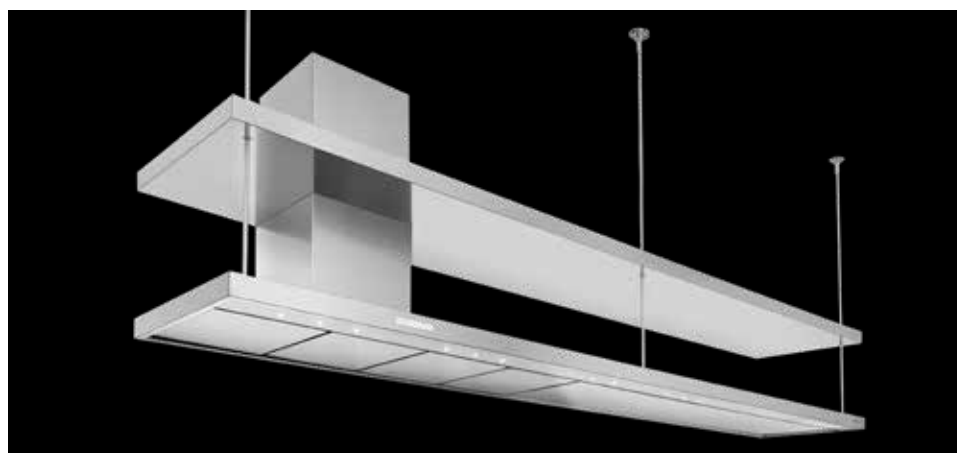

S4001



| | Sigla | Prezzo € | Disegno Tecnico |
|--|-------|----------|-----------------|
|--|-------|----------|-----------------|

S4001 parete

| | | |
|----------|--------|------------|
| 2440 091 | 90 cm | € 1.978,00 |
| 2440 121 | 120 cm | € 2.208,00 |

Cappa aspirante a parete con camino telescopico
Finitura:

acciaio satinato AISI 304
Motore Brushless - High Performance
Comandi elettronici Minimal
2 filtro antigrasso
4 velocità d'esercizio
Illuminazione LED: 6 x 1W (5.600 Kelvin)

Aspirazione perimetrale
Spegnimento automatico differito
Funzionamento filtrante opzionale

Portata: **700 m³/h**
Altezza camino: 630 – 1050 mm
Foro espulsione aria: Ø 120/150 mm
Potenza motore: 160 W
Classe energetica: A+

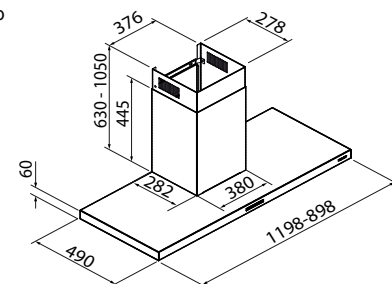

* I filtri **Long Life** garantiscono un'elevata efficacia con un ciclo di vita di ben tre anni. Il filtro Long Life può essere facilmente "rigenerato" con semplici operazioni, recuperando così la funzionalità di un filtro nuovo.

accessori:

| | Sigla | Prezzo € |
|---|----------|----------|
| kit filtro carbone - Long Life* | 9700 001 | € 114,00 |
| sistemi di canalizzazione fumi e kit silenzianti, vedi pag. 271 | | |

S4001 isola

| | | |
|----------|--------|------------|
| 2442 091 | 90 cm | € 2.708,00 |
| 2442 121 | 120 cm | € 2.911,00 |

Cappa aspirante a isola con camino telescopico
Finitura:

acciaio satinato AISI 304
Motore Brushless - High Performance
Comandi elettronici Minimal
2 filtro antigrasso
4 velocità d'esercizio
Illuminazione LED: 12 x 1W (5.600 Kelvin)

Aspirazione perimetrale
Spegnimento automatico differito
Funzionamento filtrante opzionale

Portata: **700 m³/h**
Altezza camino: 810 – 1220 mm
Foro espulsione aria: Ø 120/150 mm
Potenza motore: 160 W
Classe energetica: A+

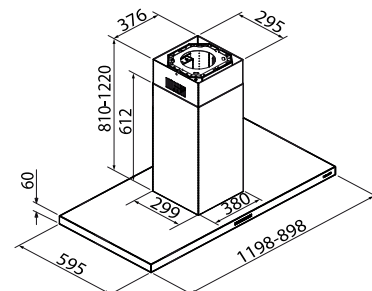

* I filtri **Long Life** garantiscono un'elevata efficacia con un ciclo di vita di ben tre anni. Il filtro Long Life può essere facilmente "rigenerato" con semplici operazioni, recuperando così la funzionalità di un filtro nuovo.

accessori:

| | Sigla | Prezzo € |
|---|----------|----------|
| kit filtro carbone - Long Life* | 9700 001 | € 114,00 |
| sistemi di canalizzazione fumi e kit silenzianti, vedi pag. 271 | | |

Cilindro



| | Sigla | Prezzo € | Disegno Tecnico |
|--|-------|----------|-----------------|
|--|-------|----------|-----------------|

Cilindro wall

2531 001

€ 1.648,00



Cappa aspirante a parete
 Finitura:
acciaio satinato AISI 304
Motore Brushless
 Comandi elettronici Minimal
1 filtro antigrasso in acciaio inox
 4 velocità d'esercizio
Illuminazione LED: 4 x 1,2W (5.500 Kelvin)
 Spegnimento automatico differito
 Funzionamento filtrante opzionale

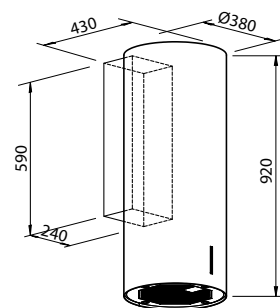

Portata: **700 m³/h**
 Altezza: 920 mm
 Foro espulsione aria: Ø 120/150 mm
 Potenza motore: 160 W
Classe energetica: A+

accessori:

filtro carbone

Sigla

9700 380

Prezzo €

€ 39,00

sistemi di canalizzazione fumi e kit silenzianti, vedi pag. 271



Cilindro island

2530 001

€ 1.849,00



Cappa aspirante telescopica a isola
 Finitura:
acciaio satinato AISI 304
Motore Brushless
 Comandi elettronici Minimal
1 filtro antigrasso in acciaio inox
 4 velocità d'esercizio
Illuminazione LED: 4 x 1,2W (5.500 Kelvin)
 Spegnimento automatico differito
 Funzionamento filtrante opzionale

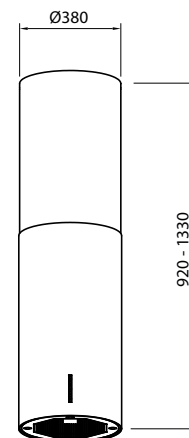

Portata: **700 m³/h**
 Altezza: 920 - 1330 mm
 Foro espulsione aria: Ø 120/150 mm
 Potenza motore: 160 W
Classe energetica: A+

accessori:

filtro carbone

Sigla

9700 380

Prezzo €

€ 39,00

sistemi di canalizzazione fumi e kit silenzianti, vedi pag. 271



FL Slim



| | Modello | Sigla | Prezzo € | Disegno Tecnico |
|---|---|-------------------|------------|---|
| FL Slim black mirror | corpo cappa black mirror | 2450 690 90 cm | € 1.222,00 |  |
| | corpo cappa white | 2450 190 90 cm | € 1.240,00 | |
| | kit camino telescopico | 2454 000 | € 99,00 | |
| FL Slim white | <p>Cappa aspirante a parete con camino telescopico (opzionale) Finitura: acciaio satinato - vetro temperato Black Mirror o White Comandi elettronici Touch 5 filtri antigrasso in acciaio inox 4 velocità d'esercizio Illuminazione 2x2,1 W LED (4.000 kelvin) Funzionamento Auto mode con sensore temperatura Doppia aspirazione: da sotto e frontale Spegnimento automatico differito 5-10-20" Funzionamento filtrante opzionale</p> <p>Portata: 725 m³/h Altezza camino (opzionale): modalità aspirante: 320-500 mm modalità filtrante: 370-560 mm Foro espulsione aria: Ø 120/150 mm Potenza motore: 175 W Classe energetica: A</p> | | | |
| | <p>accessori:</p> <p>kit filtro carbone Sigla 9700 524 Prezzo € € 82,00</p> <p>sistemi di canalizzazione fumi e kit silenzianti, vedi pag. 271</p> | | | |
|  | | | | |



Stripe e FL Slim sono dotate di una **doppia aspirazione**, con ben 5 filtri in acciaio posizionati sotto e sul fronte della cappa. Il pannello in vetro, aprendosi, migliora ulteriormente il convogliamento dell'aria.

Stripe



| | Modello | Sigla | Prezzo € | Disegno Tecnico |
|-------------------------------|---------------------------|-------------------|------------|-----------------|
| Stripe 90 Black Mirror | corpo cappa | 2450 090 90 cm | € 1.272,00 | |
| | kit camino telescopico | 2454 000 | € 99,00 | |



Cappa aspirante a parete con camino telescopico (opzionale)

Finitura:

acciaio satinato - vetro temperato Black Mirror

Comandi elettronici Touch

5 filtri antigrasso in acciaio inox

4 velocità d'esercizio

Illuminazione 2x2,1 W LED (4.000 kelvin)

Funzionamento Auto mode con sensore temperatura

Doppia aspirazione: da sotto e frontale

Spegnimento automatico differito 5-10-20"

Funzionamento filtrante opzionale

Portata: **725 m³/h**

Altezza camino (opzionale):

modalità aspirante: 320-500 mm

modalità filtrante: 370-560 mm

Foro espulsione aria: Ø 120/150 mm

Potenza motore: 175 W

Classe energetica: A

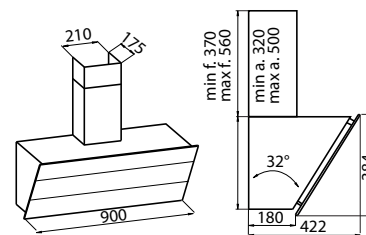

accessori:

kit filtro carbone

Sigla
9700 524

Prezzo €
€ 82,00

systemi di canalizzazione fumi e kit silenzianti, vedi pag. 271



KS Lux



| | Sigla | Prezzo € | Disegno Tecnico |
|---------------|-------------------|----------|-----------------|
| KS Lux | 2504 094 90 cm | € 834,00 | |



Cappa aspirante a parete
con camino telescopico
Finitura: acciaio satinato
Comandi elettronici
Filtri antigrasso in acciaio inox
Funzionamento Auto mode con sensore temperatura
3 velocità d'esercizio più 1 intensiva temporizzata
Illuminazione con 2 LED (4.000 kelvin)

Spegnimento automatico differito
Funzionamento filtrante opzionale
n. 3 filtri antigrasso

Portata: **700 m³/h**
Altezza camino:
in modalità aspirante 630 – 1050 mm
in modalità filtrante 700 – 1120 mm
Foro espulsione aria: Ø 120/150 mm
Potenza motore: 250 W
Classe energetica: A

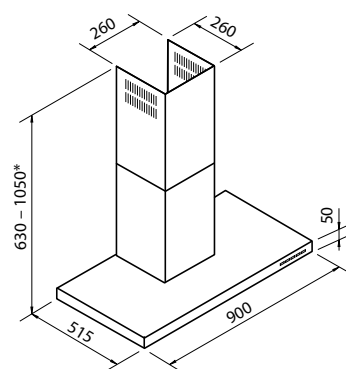

*in modalità filtrante le altezze del camino sono:
min 700 - max 1120



| accessori: | Sigla | Prezzo € |
|---|----------|----------|
| filtro carbone | 9700 528 | € 29,00 |
| sistemi di canalizzazione fumi e kit silenzianti, vedi pag. 271 | | |



| | Sigla | Prezzo € | Disegno Tecnico |
|--|-------|----------|-----------------|
|--|-------|----------|-----------------|



| | | | |
|----|-------------------|----------|--|
| KS | 2406 002 60 cm | € 534,00 | |
| | 2409 002 90 cm | € 555,00 | |

Cappa aspirante a parete con camino telescopico
 Finitura:
 acciaio satinato
 Pulsantiera meccanica
 filtri antigrasso
 cappa 90 cm: 3 filtri
 cappa 60 cm: 2 filtri
 3 velocità d'esercizio
 Illuminazione LED 2 x 1,2 W (4.000 kelvin)
 Funzionamento filtrante opzionale

Portata: **450 m³/h**
 Altezza camino: 590 – 840 mm
 Foro espulsione aria: Ø 120 mm
 Potenza motore: 125 W
Classe energetica: A

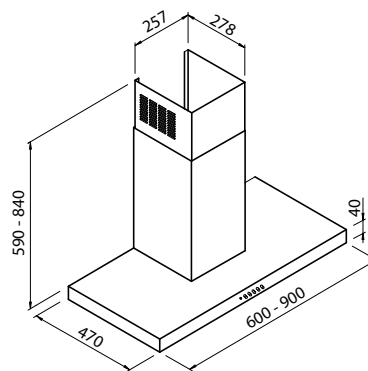



| accessori: | Sigla | Prezzo € |
|---|----------|----------|
| filtro carbone | 9700 402 | € 32,00 |
| sistemi di canalizzazione fumi e kit silenzianti, vedi pag. 271 | | |



CAPPE

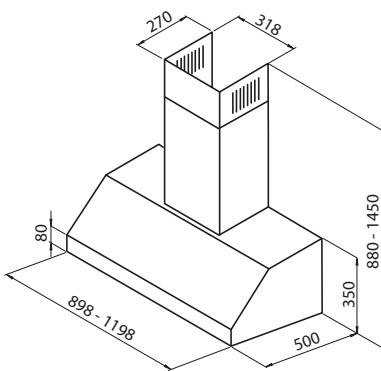

| | Sigla | Prezzo € | Disegno Tecnico | | | | |
|---|---|------------|---|-------|----------|----------|---------|
| Florence | 2538 091 90 cm | € 1.422,00 |  | | | | |
| | 2538 121 120 cm | € 1.555,00 | | | | | |
|  | <p>Cappa aspirante a parete con camino telescopico Finitura: acciaio satinato Comandi elettronici retroilluminati Filtri antigrasso baffle professionali in acciaio inox 3 velocità d'esercizio più 1 intensiva temporizzata Illuminazione (3.000 kelvin): - mod. 90: 2 x 2,1 W spot LED - mod. 120: 3 x 2,1 W spot LED Spegnimento automatico differito Funzionamento filtrante opzionale</p> <p>Portata: 730 m³/h Altezza camino: in modalità aspirante 830 – 1450 mm in modalità filtrante 1005 – 1450 mm Foro espulsione aria: Ø 120/150 mm Potenza motore: 150 W Classe energetica: A</p> | | | | | | |
|  | <p>accessori:</p> <p>filtro carbone</p> <p>sistemi di canalizzazione fumi e kit silenzianti, vedi pag. 271</p> | | <table border="1"> <thead> <tr> <th>Sigla</th> <th>Prezzo €</th> </tr> </thead> <tbody> <tr> <td>9700 292</td> <td>€ 51,00</td> </tr> </tbody> </table> | Sigla | Prezzo € | 9700 292 | € 51,00 |
| Sigla | Prezzo € | | | | | | |
| 9700 292 | € 51,00 | | | | | | |



Non solo l'aspetto è professionale nella cappa Florence, i filtri tipo Baffle garantiscono prestazioni superiori nel filtraggio dei grassi.

Pitagora



| | Sigla | Prezzo € | Disegno Tecnico |
|--|-------|----------|-----------------|
|--|-------|----------|-----------------|

Pitagora 90x90

2439 003

€ 1.414,00



Cappa aspirante angolare con camino telescopico
 Finitura:
acciaio satinato AISI 304
 Comandi elettronici Minimal
 2 filtri antigrasso
 4 velocità d'esercizio
 Illuminazione LED (2x1,2 W) - 4.000 kelvin
 Spegnimento automatico differito
 Funzionamento filtrante opzionale

Portata: **750 m³/h**
 Altezza camino: 450 – 850 mm
 Foro espulsione aria: Ø 150 mm
 Potenza motore: 250 W
Classe energetica: A

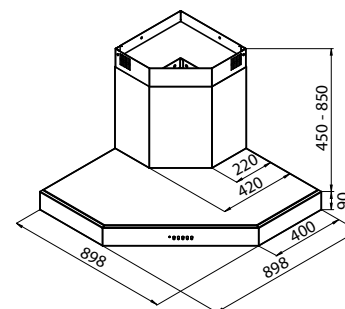

accessori:

filtro carbone

Sigla

9700 409

Prezzo €

€ 36,00

sistemi di canalizzazione fumi e kit silenzianti, vedi pag. 271

Pitagora è la cappa perfetta per le soluzioni cottura angolari Foster:
 Quadra Angolare, pag 231
 Angolare, pag 247



Amélie



| | Sigla | Prezzo € | Disegno Tecnico |
|--|-------|----------|-----------------|
|--|-------|----------|-----------------|

Amélie

2447 090
90 cm

€ 622,00



Cappa aspirante a parete con camino telescopico
 Finitura: acciaio satinato
 Comandi elettronici soft touch
 3 filtri antigrasso
 3 velocità d'esercizio
 Illuminazione 2x2,1 W LED (4.000 kelvin)
 Funzionamento filtrante opzionale

Portata: **620 m³/h**
 Altezza camino:
 modalità aspirante: 580-1000 mm
 modalità filtrante: 650-1070 mm
 Foro espulsione aria: Ø 120/150 mm
 Potenza motore: 220 W
Classe energetica: A

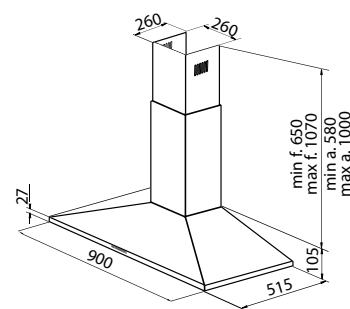
**accessori:**

filtro carbone

sistemi di canalizzazione fumi e kit silenzianti, vedi pag. 271

Sigla

9700 517

Prezzo €

€ 41,00

New Wing



| | Sigla | Prezzo € | Disegno Tecnico |
|--|-------|----------|-----------------|
|--|-------|----------|-----------------|

New Wing

| | | |
|----------|-------|----------|
| 2512 062 | 60 cm | € 616,00 |
| 2512 092 | 90 cm | € 646,00 |



Cappa aspirante da incasso sottopensile
 Finitura: acciaio satinato / vetro
Comando rotativo Smart
 Filtri antigrasso in alluminio
 cappa 60 cm: 2 filtri
 cappa 90 cm: 3 filtri
 4 velocità d'esercizio
 Illuminazione 2 LED (4.000 kelvin)
Profili di protezione pensili in acciaio inox
Regolatore di profondità telescopico
 Profilo ferma-schienale pensile
 Funzionamento filtrante opzionale
 Altezza minima dal piano: **solì 50 cm**

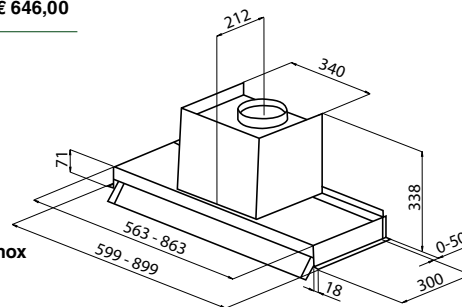

Portata: 620 m³/h
 Foro espulsione aria: Ø 150 mm
 Potenza motore: 210 W
Classe energetica: A

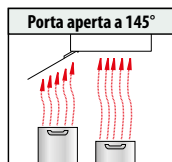
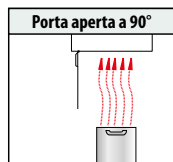
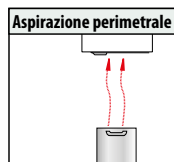

| accessori: | Sigla | Prezzo € |
|---|----------|----------|
| kit filtri carbone | 9700 221 | € 37,00 |
| sistemi di canalizzazione fumi e kit silenzianti, vedi pag. 271 | | |

Flat



| | Sigla | Prezzo € | Disegno Tecnico |
|--|--|---|---|
| Flat white  | 2513 161 60 cm | € 1.121,00 |  |
| | 2513 191 90 cm | € 1.198,00 | |
| | 2513 121 120 cm | € 1.303,00 | |
| Articolo ad esaurimento | | | * il box coprimotore e il camino sono accessori opzionali |
|  | La cappa si fissa alle spalle del pensile | Cappa aspirante da incasso sottopensile camino telescopico e box coprimotore inox opzionali Finitura: Vetro bianco Comandi elettronici Touch Filtri antigrasso cappa 60 cm: 1 filtro cappa 90 cm: 2 filtri cappa 120 cm: 4 filtri | 4 velocità d'esercizio Illuminazione striscia LED (4.200 kelvin) Spegnimento automatico differito Aspirazione perimetrale Funzionamento filtrante opzionale Portata: 750 m³/h Foro espulsione aria: Ø 120/150 mm Potenza motore: 275 W Classe energetica: A |

| | Sigla | Prezzo € | Disegno Tecnico |
|------------------|--------------------|------------|-----------------|
| Flat inox | 2513 061 60 cm | € 996,00 | |
| | 2513 091 90 cm | € 1.066,00 | |
| | 2513 021 120 cm | € 1.186,00 | |



* il box coprimotore e il camino sono accessori opzionali



La cappa si fissa alle spalle del pensile

Cappa aspirante da incasso sottopensile
camino telescopico e box coprimotore inox opzionali
Finitura: acciaio satinato
Telecomando incluso
Comandi elettronici Easy
Filtri antigrasso
cappa 60 cm: 1 filtro - cappa 90 cm: 2 filtri
cappa 120 cm: 4 filtri

4 velocità d'esercizio
Illuminazione striscia LED (4.200 kelvin)
Spegnimento automatico differito
Aspirazione perimetrale
Funzionamento filtrante opzionale
Portata: **750 m³/h**
Foro espulsione aria: Ø 120/150 mm
Potenza motore: 275 W
Classe energetica: A

DIMENSIONI BOX COPRIMOTORE E CAMINO (opzionali)

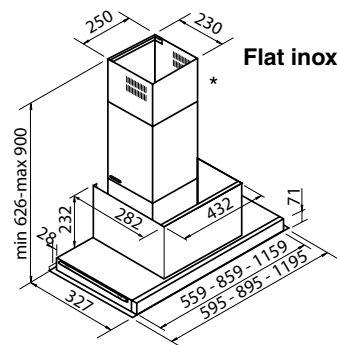
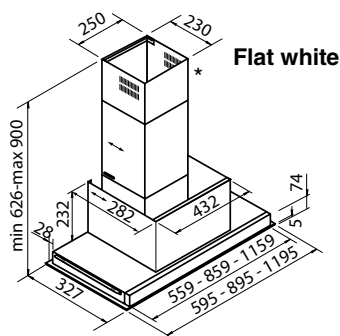

| accessori cappe Flat: | Sigla | Prezzo € |
|---|----------|----------|
| filtro carbone | 9700 600 | € 33,00 |
| sistemi di canalizzazione fumi e kit silenzianti, vedi pag. 271 | | |
| camino telescopico inox | 2539 000 | € 99,00 |
| box coprimotore inox | 2539 200 | € 82,00 |



LAVASTOVIGLIE



Programmi: set di programmi pratici e essenziali e una programmazione completa e sofisticata adatta ad ogni singola esigenza.



Mezzo carico: risparmio di tempo e di consumi con la impostazione mezzo carico, disponibile su tutti i programmi.



Acquastop: blocca l'alimentazione dell'acqua e impedisce alla fonte perdite e trabocchi. È in dotazione su tutti i modelli.



Programmazione differita: per impostare il funzionamento in modo a ottimizzare il consumo di energia nel corso della giornata.

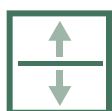

Cestello regolabile: il cestello superiore è regolabile in altezza con un semplice gesto, anche a pieno carico.



Tabs "All in 1": risultati ottimizzati con tutti i tipi di detersivo, delle pratiche Tabs "all in one" al detersivo classico.

Lavastoviglie

KS Plus **NEW**

| | Sigla | Prezzo € |
|----------------------------------|----------|------------|
| Lavastoviglie a scomparsa totale | 2941 001 | € 1.223,00 |



Accessori: Pannello porta acciaio inox - per anta fissa

Classe energetica F
Numero coperti 13

consumo energia 103 kWh/100 cicli eco
consumo acqua per ciclo: 12 litri
Emissione rumore: 48 dB(A) classe C
Programmazione elettronica
Pannello digitale

10 programmi di lavaggio:

ammollo, cristalli, eco, quick, auto, ultraclean, eco rapid, delicato rapid, daily clean, intensivo rapid
Cestello superiore regolabile
con pulsante su 3 livelli
Cestello portaposate

Sistema di sicurezza Acquastop

Opzione Mezzo carico distribuito

Programmazione differita 24h

Programma sanificazione

Spie mancanza sale-brillantante

Impostazione per detersivi multiuso (tasto 3 in 1)

Indicatore fine ciclo:

acustico + luce a pavimento

Attacco pannello porta con sistema Slider e fisso

Regolazione frontale dei piedini posteriori

Altezza piedini 0-70 mm

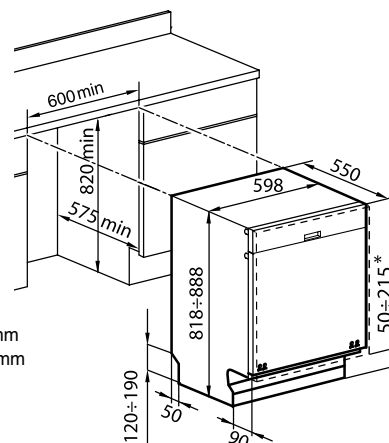
Dati tecnici

tensione di alimentazione:
220-240 V - 50Hz

Limiti dimensionali pannello porta:

spessore 18-28 mm

altezza (con pannello fisso) 660-720 mm

altezza (con pannello slider) 660-770 mm

peso pannello porta: 2,5 - 11 Kg

dimensioni zoccolo: 50÷215 mm*

* con pannello slider

Elettra **NEW**

| | Sigla | Prezzo € |
|----------------------------------|----------|----------|
| Lavastoviglie a scomparsa totale | 2950 002 | € 840,00 |



Accessori: Pannello porta acciaio inox

Classe energetica E
Numero coperti 12

consumo energia: 92 kWh/ 100 cicli Eco
consumo acqua per ciclo: 12 litri
Emissione rumore: 47 dB(A) classe C
Programmazione elettronica

5 programmi lavaggio:

intensivo, prelavaggio, quick 30',
eco, daily clean.

Funzione mezzo carico

Sistema di sicurezza Acquastop

Programmazione differita 19 ore

Spie mancanza sale-brillantante

Carrello superiore regolabile

in altezza a pieno carico

Cestello portaposate

Regolazione frontale dei piedini posteriori

Altezza piedini 0-50 mm

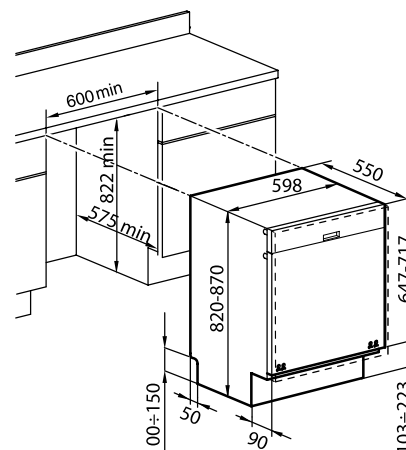
Dati tecnici

tensione di alimentazione:
220-240 V - 50Hz

Limiti dimensionali pannello porta:

altezza 647-717 mm

peso pannello: 3 - 8 Kg

accessori
Pannello porta acciaio inox

| Sigla | Prezzo € |
|----------|----------|
| 2910 018 | € 274,00 |

finitura: AISI 304 spazzolato
misure: 595x716x20 mm

La maniglia integrata si abbina facilmente a qualsiasi anta cucina.
Compatibile con lavastoviglie KS Plus ed Elettra.

Gli Speciali di Foster - TOP INOX

Le realizzazioni su misura sono tra gli elementi più distintivi delle produzioni Foster.

Per conoscere tutte le possibilità di realizzazioni di piani di lavoro su misura, in acciaio e in materiali compositi, si rimanda alla documentazione tecnica dell'azienda del **Gruppo Foster** specializzate nelle realizzazioni on demand.

www.bautek.it e www.fostersurfaces.it



Un unico materiale, tanti diversi look grazie ad una gamma di proposte che spazia tra i classici satinati, i nuovi trattamenti ruvidi e opachi e il tocco retrò della finitura Vintage.

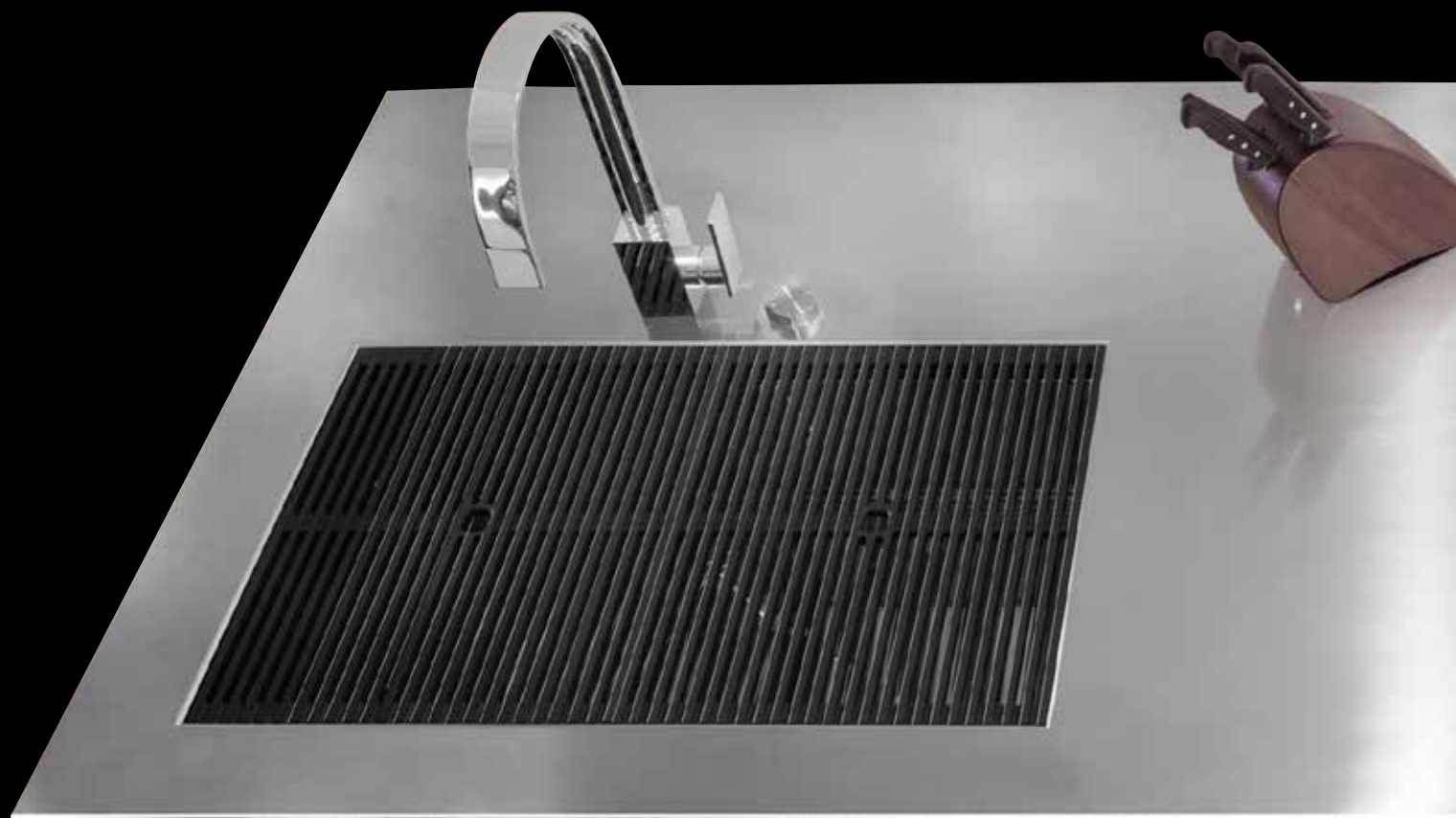

- Diverse finiture.
- Differenti profili e spessori.
- Supporti autoportanti.
- Infinite soluzioni per ogni esigenza di progetto.

Un piano speciale di Foster vuole dire anche la sicurezza di una qualità artigianale di altissimo livello e la garanzia di un unico produttore sull'intero manufatto.



Anche quello che non si vede è importante. Tutti i nostri top sono realizzati con materiali di primissima scelta e hanno una struttura interna che li rende autoportanti.

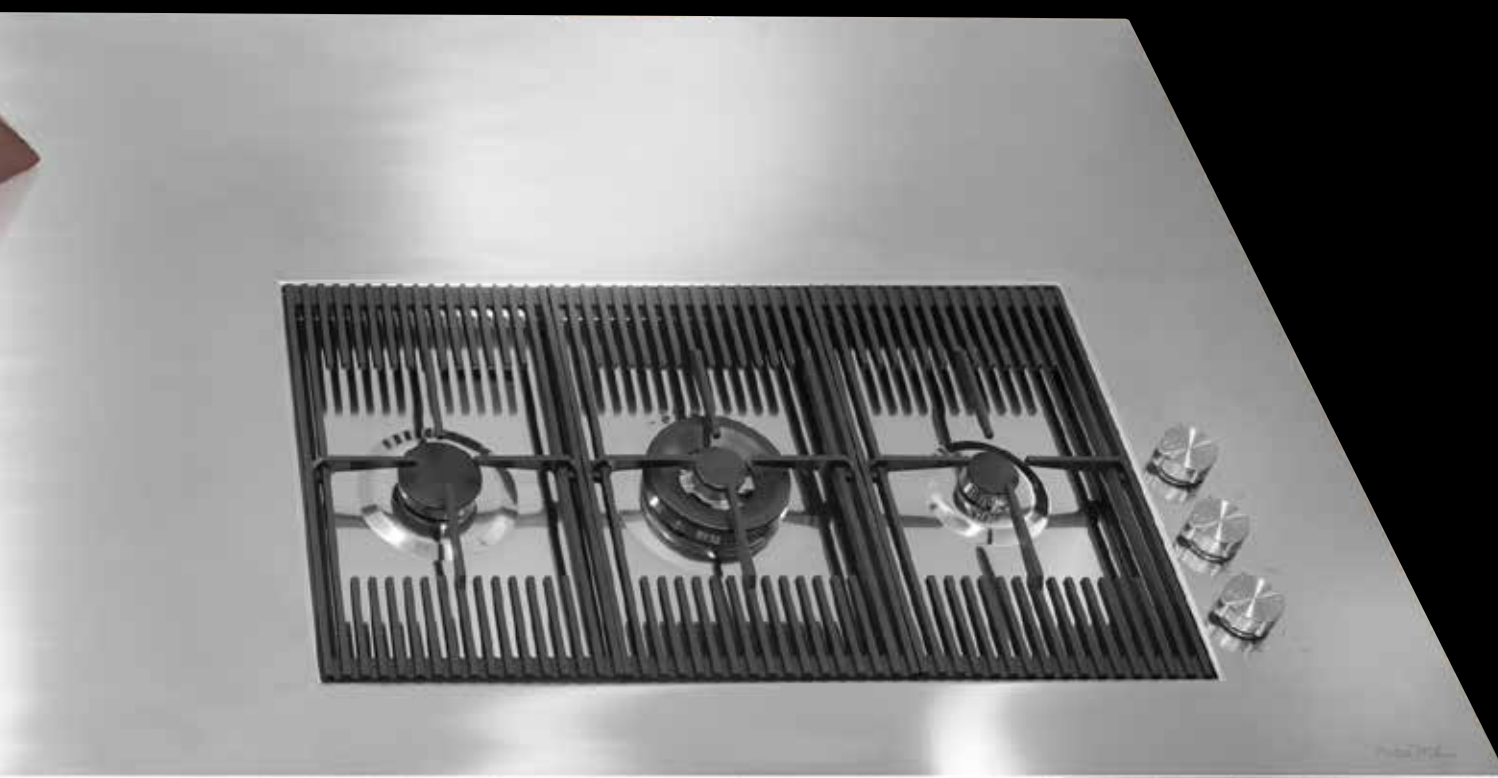



Prodotti pulizia acciaio

I prodotti in acciaio inossidabile non hanno bisogno di manutenzione particolare; tuttavia è opportuno adottare alcuni accorgimenti e utilizzare detergenti adeguati per la pulizia quotidiana. In generale **sono sufficienti un lavaggio con acqua calda e sapone o acqua calda e aceto**, un abbondante risciacquo e un'asciugatura con un panno. Sono da evitare: l'acido cloridrico, polveri abrasive, pagliette, spazzole e sostanze per pulire l'argento.

Per orientarvi nella scelta dei detergenti, Foster propone i prodotti della linea "Steel Clean" per la pulizia dell'acciaio:

- **panno in microfibra**, per eliminare velocemente tracce di unto, grasso e polvere.
- **crema professionale** per restituire l'originale splendore all'acciaio, rimuove incrostazioni di calcare, sporco ostinato ed eventuali macchie di ruggine causate dal contatto prolungato di oggetti ferrosi.



Steel Clean - crema
Crema detergente per acciaio inox

| flacone 250 ml | | |
|-------------------|--|----------|
| Sigla | | Prezzo € |
| 8331 000 | | € 14,00 |
| confezione 12 pz. | | |
| Sigla | | Prezzo € |
| 8331 012 | | € 162,00 |



Steel Clean - microfibra
Panni in microfibra per la pulizia dell'acciaio inox

| confezione 3 pz. | | |
|------------------------|--|----------|
| Sigla | | Prezzo € |
| 8333 000 | | € 26,00 |
| 12 confezioni da 3 pz. | | |
| Sigla | | Prezzo € |
| 8333 012 | | € 270,00 |

Foster è azienda certificata ISO 9001:2015
Registration number CH-36474



GARANZIE

Tutti i prodotti Foster sono conformi alle direttive CEE e sono coperti da garanzia Foster per 24 mesi.

ASSISTENZA

Desideriamo darvi un prodotto ed un servizio all'altezza della vostra scelta, per questo Foster è dotata di una capillare rete di Centri di Assistenza Tecnica, in Italia e all'estero.

SERVIZIO POST-VENDITA

Per conoscere l'elenco sempre aggiornato dei centri di assistenza tecnica Foster consultate il sito internet **www.fosterspa.com**



I prezzi del presente listino sono da considerarsi al netto di IVA.

Foster declina ogni responsabilità per eventuali inesattezze ed errori e si riserva il diritto di apportare modifiche e migliorie ai prodotti illustrati in qualsiasi momento senza preavviso. Ogni articolo del presente catalogo è prodotto in conformità alle normative vigenti e alle direttive CE.

L'organizzazione Foster sarà lieta di fornire ulteriori dettagli ed aggiornamenti sui nostri prodotti e servizi.

Realizzato in collaborazione con Maxistudio.net.

Foster 